

# electronics

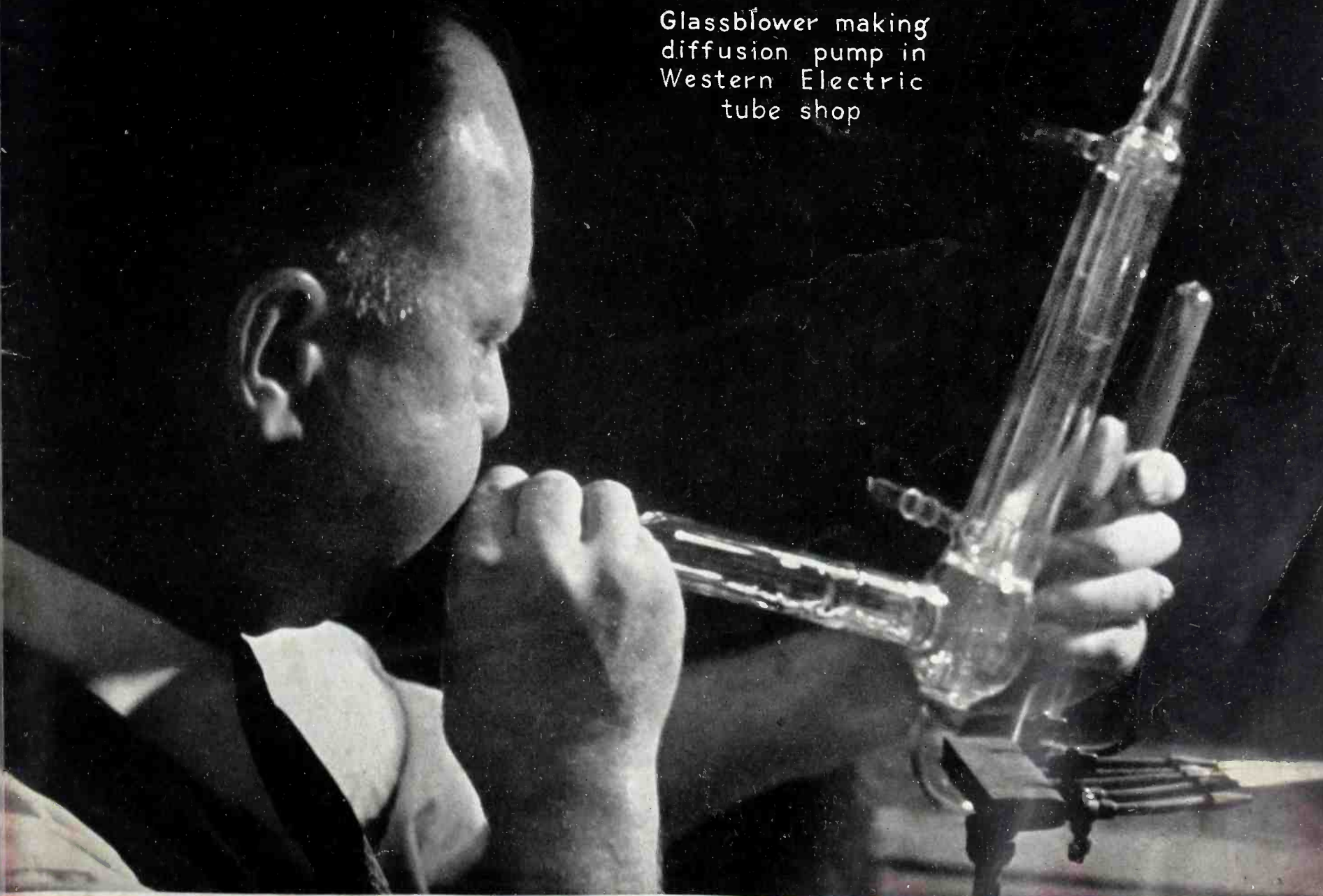

Glassblower making  
diffusion pump in  
Western Electric  
tube shop



McGRAW-HILL  
PUBLISHING COMPANY, INC.

**SEPTEMBER**

**1936**

[www.americanradiohistory.com](http://www.americanradiohistory.com)

Price 50 Cents

# AMPERITE LEADERSHIP IN QUALITY

ADVANCES AGAIN WITH..



*New*  
**RING-CORE TRANSFORMER**

*New*  
**PRE-AMPLIFIER**

*New*  
**MICROPHONE STANDS**

"CONSTANT IMPROVEMENT" IS THE KEYNOTE OF AMPERITE ENGINEERING ACTIVITY. WE BELIEVE THAT ONLY THE HIGHEST IN QUALITY IS DESIRED BY BROADCASTING STUDIOS. THAT IS WHY THE AMPERITE VELOCITY HAS BEEN BUILT UP TO THE POINT WHERE IT IS THE FINEST MICROPHONE AVAILABLE TODAY, REGARDLESS OF PRICE. SEE FREE TRIAL OFFER BELOW.

*New* **EXCLUSIVE FEATURE**

Again, Amperite demonstrates leadership by being the first to use the Ring-Core (the ideal) Transformer commercially. The Amperite SR-80 Velocity incorporates this superior transformer. Its low distributed capacity decreases the high frequency attenuation to an absolute minimum, resulting in more brilliant reproduction. Inductive pickup is reduced to absolute minimum... **NEW INPUT TRANSFORMER**, ring-core type, also available to studios. Secondary impedance 250,000 ohms.

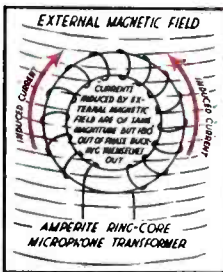

**FOR STUDIOS—AMPERITE MODEL SR-80**

High fidelity. Accurate definition. Natural brilliance. No background noises. No peaks. Can be placed up to 2000 feet from the amplifier without appreciable loss. Frequency response 30 to 14,000 C.P.S. Output, -64 db (open line); -90 db when using input transformer (100,000 ohms sec-

ondary). Hand-hammered ribbon not affected by even a 40-mile gale. Available also in High Impedance Model SR-80H, which operates directly into grid of tube. New design permits running 1/4" cable up to 125 feet. **LIST PRICE (SR-80 or SR-80H) \$80.00.** Call Letter Plate. List \$5.00.

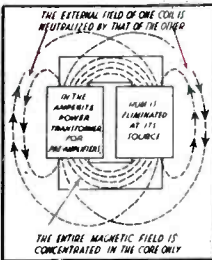

*New* **AC (OR BATTERY-OPERATED) PRE-AMPLIFIER**

Features two new advantages: Balance-wound Power Transformer which reduces inductive hum to a minimum; Input Transformer of the Ring-Core type, which increases the signal level at the most desired point... Frequency response, 30 to 12,000 CPS ( $\pm 1$ db). Paper condensers used in power supply. Transformer coupled—highest grade nickel alloy core used. Table or rack mounting.

**AMPERITE BOOM STAND (MODEL FSB)**

Adjustable in any direction. Noiseless action permits noiseless adjustment while operating. Adjustable counterweight and friction clutch provide smooth and easy operation: The Boom can be lowered or raised by mere pressure of the hand, without requiring any locking devices. Microphone height can be varied from 36" to 96". Length of boom arm, 28". (Other lengths obtained upon request at slight extra charge. **LIST PRICE, \$50.00.**

**AMPERITE Company** 561 BROADWAY NEW YORK

VELOCITY **AMPERITE** MICROPHONES

A COMPLETE LINE—FILLING EVERY BROADCASTING NEED!

**TWO WEEKS' FREE TRIAL**

You are invited to conduct a **TWO WEEKS' FREE TRIAL** of our microphones and accessories. No deposit. No obligation whatever. All we ask is that you make the test exhaustive. Then decide whether you want to keep the microphone or return it. Behind this **FREE TRIAL** offer is the conviction that Amperite offers the finest microphones available today, regardless of price!

Cable Address: Alkem, New York

# ELECTRONICS

radio, communication and industrial applications of electron tubes . . . design, engineering, manufacture

HOWARD EHRLICH  
Vice-President

KEITH HENNEY  
Editor

DONALD G. FINK  
Associate Editor

H. W. MATEER  
Manager

## Contents • September 1936

COVER: *A vacuum pump (mercury diffusion type)  
under construction at the Western Electric tube shop*

### Circuits for Politics . . . . . 12

BY H. A. RAHMEL AND C. H. WARRINER  
The G. O. P. Committee has an engineering staff  
for broadcast and public address facilities

### Cathode Rays for the UHF . . . . . 15

BY LESTER L. LIBBEY  
Correction factors permit use of Cathode ray tubes  
up to 300 mc.

### Reactors in D-C Service . . . . . 18

BY REUBEN LEE  
Design data taking direct current flow into  
account

### A Static-Velocity Microphone . . . . . 21

Dural ribbons in a capacity type unit give a  
velocity-type response

### The Sommerfeld Formula . . . . . 23

BY WILLIAM A. FITCH  
Curves for simplifying the prediction of field-  
strengths about broadcast antennas

### An End-of-Life Meter . . . . . 26

BY H. W. LORD AND O. W. LIVINGSTON  
Circuits for indicating the end of useful life in  
grid-controlled rectifiers

### Automatic Frequency Control Circuits . . . . . 28

BY S. YOUNG WHITE  
Criteria for successful operation of AFC circuits

### Beam Tube Amplifiers . . . . . 30

BY LEON OXMAN  
A degenerative system using the new 6L6 beam  
tubes to obtain a triode-type output

### Patents Practice Essentials . . . . . 33

BY THAD GOLDSBOROUGH  
What every inventor should know, for reference  
use

### The Bell Telephone Laboratories (insert)

Behind the scenes in one of the greatest industrial  
research organizations

## DEPARTMENTS

Crosstalk . . . . .	11	Tubes at Work . . . . .	36	Electron Art . . . . .	60
Reference Sheet . . . . .	33	New Books . . . . .	32	Manufacturing Review . . . . .	78
		Index to Advertisers . . . . .	100		

Volume 9 . . . . . Number 9

ELECTRONICS, September 1936, Vol. 9, No. 9. Published monthly, price 50c a copy. Subscription rates—United States, \$5.00 a year. Latin America, \$5.00 a year. Canada, \$5.00 a year. All other countries, \$6.00 a year or 24 shillings. Entered as Second Class matter, August 29, 1936, at Post Office, Albany, N. Y., under the Act of March 3, 1879.

Branch Offices: 520 North Michigan Ave., Chicago; 883 Mission St., San Francisco; Aldwych House, Aldwych, London, W. C. 2; Washington; Philadelphia; Cleveland; Detroit; St. Louis; Boston; Atlanta, Ga.

Contents Copyright, 1936, by McGraw-Hill Publishing Company, Inc.

## McGRAW-HILL PUBLISHING COMPANY, INC.

Publication Office, 99-129  
North Broadway, Albany, N. Y.

Editorial and Executive Offices  
330 West 42d Street, New York, N. Y.

James H. McGraw, Jr.  
Chairman  
Howard Ehrlich  
Vice-President

Malcolm Muir  
President  
B. R. Putnam  
Treasurer

James H. McGraw  
Honorary Chairman  
D. C. McGraw  
Secretary

Cable Address: MCGRAWHILL, New York. Member A.B.P. Member A.B.C.



# THIS IS THE HOUSE

our good friends<sup>★</sup>  
helped us build

Young in years but old in experience—describes briefly the business that has been built up around our service.

The fact that there is no substitute for experience—that when a certain class of work can be done better by one concern than another—that in doing this class of work a definite service is rendered—are some of the reasons for the phenomenal growth of the Superior Tube Company.

# SUPERIOR TUBE

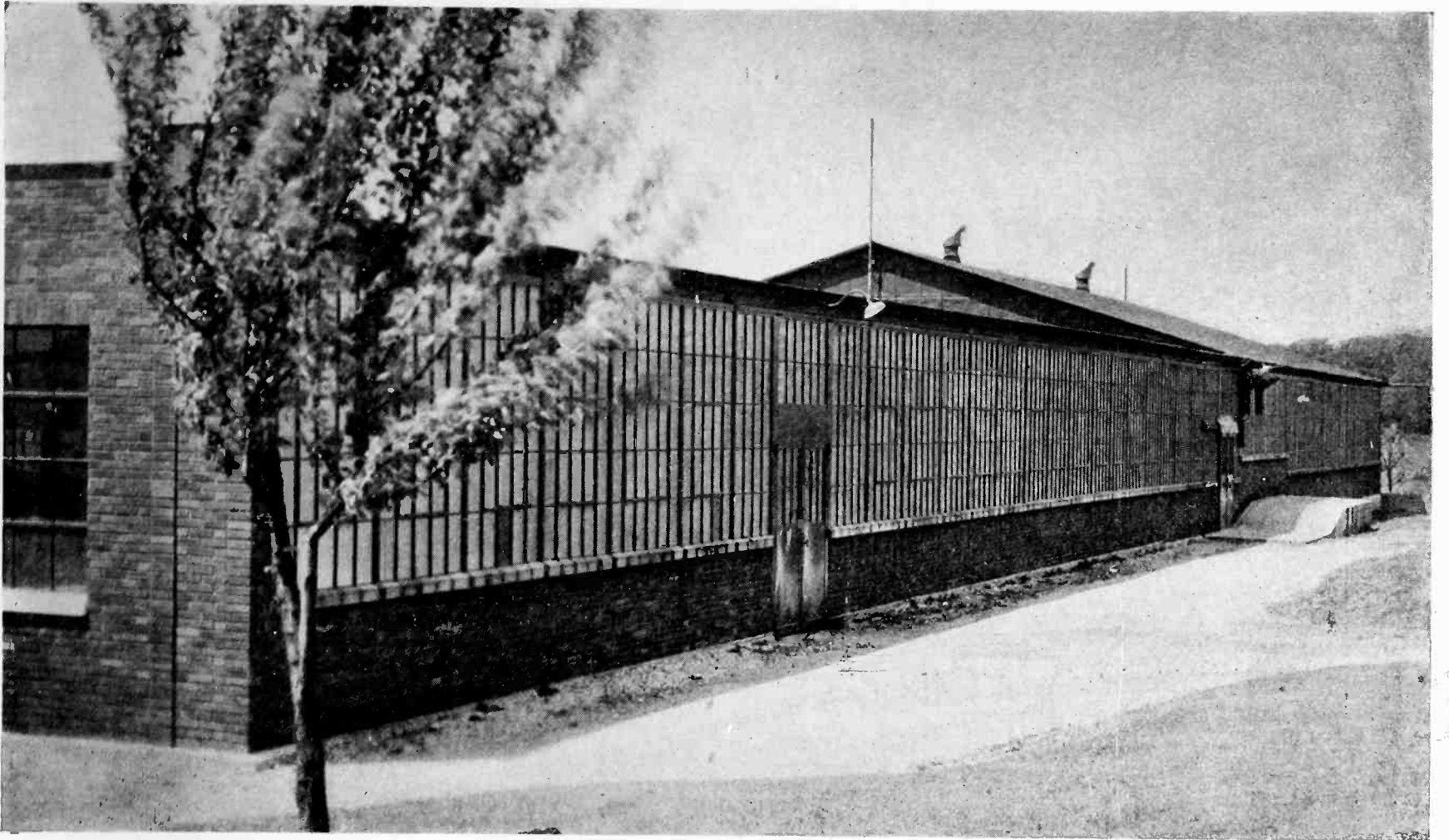

In less than two years time, the ability of this company to produce small, fine, seamless tubing to unusual specifications has become known throughout industry and especially in electronic fields where accuracy in manufactured products is measured by laboratory standards and specifications dictated accordingly.

The modern plant pictured above is more than physical evidence of our size. It is an expression of the confidence which users place in our ability to fabricate small seamless tubing to their most exacting needs. We dedicate our house to those who helped us build it—our good friends and customers.

To all, we extend a cordial invitation to visit us in Norristown, Pa. (25 miles from Philadelphia, 100 miles from New York City). You'll find here a plant, modern in every detail, and just as unique as the service it renders.



*The Bell Telephone Laboratories are one of the many organizations which we have served in the past year.*

## **COMPANY, NORRISTOWN, PA.**

FOR TONE CONTROL... SENSITIVITY CONTROL, ETC.

*Specify the compact*

# STACKPOLE ROTARY SWITCHES

## Slow Break Type

Type T.S. — Without snap switch — grounded or insulated common connection.

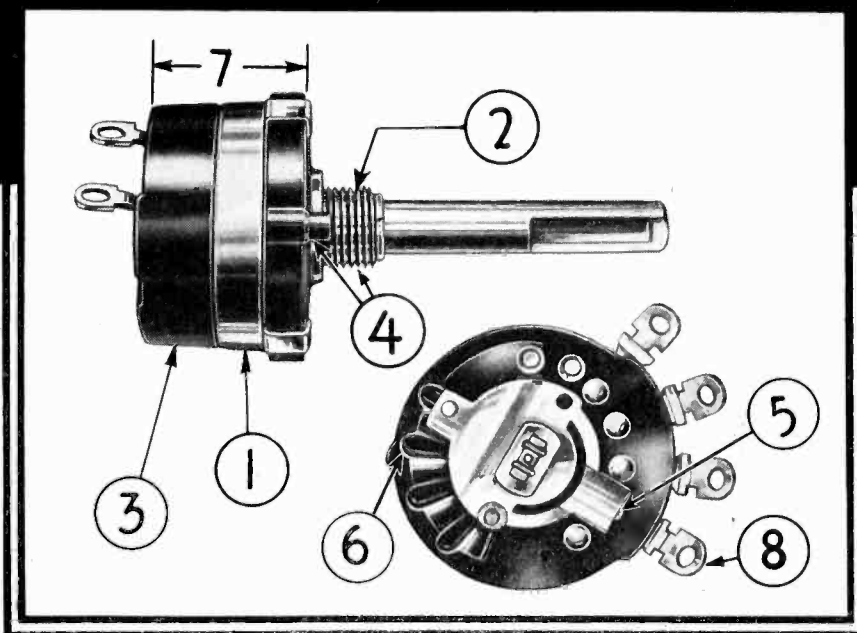

Type T.S.M. — Same as Type T.S. with snap switch added.

### NOTE THESE ADVANTAGES

1. Totally enclosed keeping out dust, metallic particles and other foreign matter.
2. May have insulated common terminal or have grounded construction, using bushing as common terminal.
3. May be equipped with snap switch to break power connection.
4. Standard mounting bushings and locating pins.
5. Very low contact resistance.
6. Positive indent action.
7. Very small and compact; type without snap switch only 29/64" thick, with switch only 25/32".
8. Large, easily soldered lugs.

Samples will be gladly sent for examination and approval.

Write—

**STACKPOLE CARBON COMPANY**  
**ST. MARYS, PENNA., U.S.A.**

These products are sold only to manufacturers of original equipment.



**AUDAX**  
*Microdyne*  
THE "RELAYED-FREQUENCY" PICK-UP

Not since pick-ups became an accomplished fact in 1926 has a more startling achievement been announced. Through radical new developments, AUDAX has conjured forth recording—MICROPHONE fidelity from the pick-up itself. Moving mass and its attendant limitations are now abolished! But that's not the half of it . . . as you'll find out when you listen to the realistic *facsimile* performance of MICRODYNE. Yes . . . MAGNETO-INDUCTIVE!

**AUDAX COMPANY, 500 Fifth Avenue, New York.**

*"Creators of High Grade Electrical and Acoustical Apparatus Since 1915"*

*Performance-Proven  
Resistance Pins*

**+**

*Color-Coded  
Ceramic Shells*

**=**

**ERIE Insulated  
RESISTORS**

**RESISTOR  
DIVISION**

Insulated and  
non-insulated  
carbon resistors

Auto Radio  
Suppressors

The resistance pins of Erie Insulated Resistors are solid molded from the same time-proven carbon composition that has made non-insulated Erie Resistors outstanding for their unsurpassed all-round operating performance.

Enclose these pins in uniform, pre-formed, insulating ceramic cases that are brightly color coded for instant identification . . . complete the assembly by making strong, one-piece, solderless connections of the tinned copper lead wires . . . and you have Erie Insulated Resistors.

That, briefly, is the story of these units. It's not hard to see their inherent advantages. We're eager to have you find them out through actual use. A letter to us will bring you a generous supply of samples.

**ERIE RESISTOR CORP.**

TORONTO, CAN.

ERIE, PA.

LONDON, ENG.

**PLASTICS  
DIVISION**

Radio knobs,  
dials and other  
small plastic  
pieces molded  
by the injection  
process.

Bell Telephone Laboratories are among our customers for Erie Resistors

**ERIE RESISTORS**



# CINCH

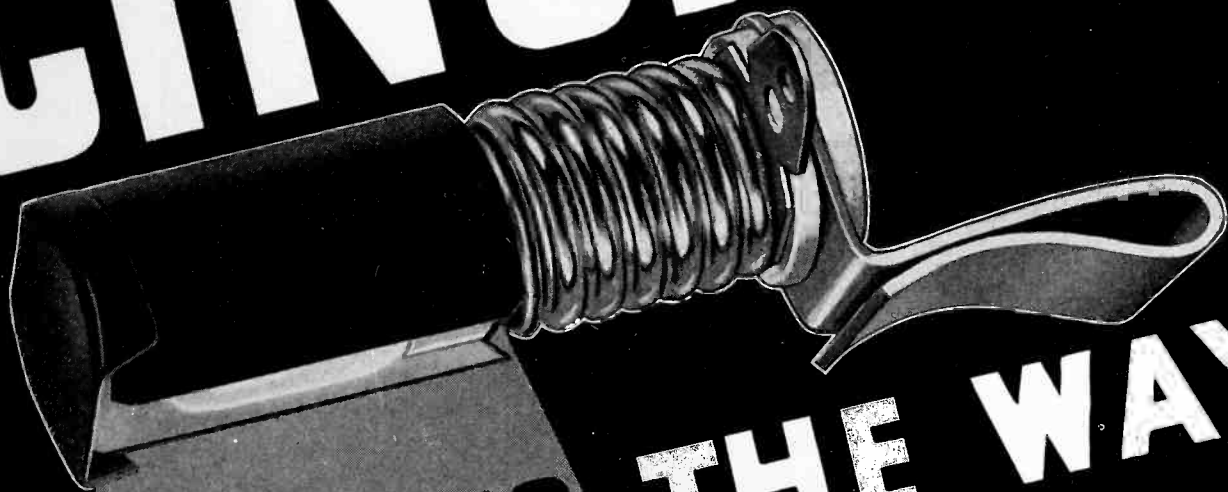

# LIGHTS THE WAY

Approximately  
three times ac-  
tual size.

Upper Left  
Socket No. 3146

Right; Cap shield  
for directed, con-  
centrated light  
No. 48730

Dial Light Socket  
No. 48722-1

Dial Light Socket  
(right) No. 99043

Dial Light Socket  
(left) No. 99129

Dial Light Socket  
No. 3153

Lower Right; No.  
3110



With a wide variety of mounting methods to choose from, Cinch dial light sockets assure mechanical and electrical perfection in illuminating dials under any set specification or construction. Some of the more generally used types are pictured here. There are many others.

**Wherever the light, Cinch shows the way to mount it.**

Only the best materials and painstaking workmanship can produce these carefully designed parts; all metal parts are plated, and all assemblies are inspected and tested. The spring contact in the Cinch screw type sockets prevents vibration loosening the lamp and makes good contact certain. Samples and further detail upon request.

*"Cinch" and Oak Radio sockets are licensed under H. H. Eby Socket Patents.*

# CINCH MANUFACTURING CORP.

2335 WEST VAN BUREN STREET, CHICAGO, ILLINOIS

Subsidiary: United-Carr Fastener Corporation, Cambridge, Mass.

# BULLETIN BOARD

## S.S.WHITE FLEXIBLE SHAFTS

-- September 1936 --

### S. S. WHITE METALLIC CASINGS for Auto Radio Remote Controls

#### C H A R A C T E R I S T I C S

Casing Designation	No.147A1*	No.147A2*	No.170A1**	No.170A2**
Finish	Gray Parkerized	Galvanized	Gray Parkerized	Galvanized
Number of Wires used - "D" shaped	2	2	2	2
"Triangle" shaped	2	2	2	2
Stress Strain in Tension				
Average inches elongation per foot-				
at 5 lb. load	.002"	.011"	.005"	.003"
15 lb. load	.019"	.134"	.128"	.085"
25 lb. load	.119"	.276"	.330"	.280"
Average inches permanent elongation				
per foot at 5 lb. load	.001"	.002"	.002"	.001"
15 lb. load	.003"	.010"	.008"	.010"
25 lb. load	.015"	.015"	.020"	.032"
Bend Set Test (See Note below)				
Degrees bend around 1-3/8" diameter				
to set 10 degrees	40°	40°	50°	50°
Bending Moment to give 10 degree set	8 in.-lbs.	8 in.-lbs.	9 in.-lbs.	9 in.-lbs.
Average Weight of Casing - feet per lb.-	14 ft.	14.5 ft.	12 ft.	13 ft.
<i>Note: A relative measure of stiffness of casing determined on specially designed test fixture</i>				
<u>Dimensions of Casings</u>				
Inside Body Diameter - Minimum	.147"	.147"	.170"	.170"
- Maximum	.152"	.152"	.175"	.175"
Outside Body Diameter- Minimum	.233"	.233"	.253"	.253"
- Maximum	.238"	.238"	.258"	.258"
Length -- to specifications plus and minus 1/16"				

#### D I M E N S I O N S O F C A S I N G E N D S

CASING NUMBER	PLAIN END		INTEGRAL ENLARGED END			INTEGRAL FLANGED END								
	I.D.		I.D.	O.D.		C	I.D.		O.D.		C			
	Min.	Max.	Min.	Min.	Max.		Min.	Max.	Min.	Max.	Min.	Max.		
147A1 and 147A2	.147"	.157"	.233"	.243"	13/64"	.365"	.375"	3/8"	.147"	.157"	.422"	.438"	.120"	.130"
170A1 and 170A2	.170"	.180"	.253"	.263"	13/64"	.365"	.375"	3/8"	.170"	.180"	.422"	.438"	.120"	.130"

FINISH - Parkerized for exposed controls - Galvanized for controls on dashboard.

\*CASINGS Nos.147A1 and 147A2 - for use with S.S.WHITE .130" dia. Radio Shaft

\*\*CASINGS Nos.170A1 and 170A2 - for use with S.S.WHITE .150" dia. Radio Shaft

WOULD YOU LIKE SAMPLES?...A request on your business letterhead will bring them.

**The S.S.WHITE Dental Mfg. Co. INDUSTRIAL DIVISION**  
10 EAST 40th ST. ROOM 2310 E, NEW YORK, N.Y.

# THE ULTIMATE IN SUPER-SENSITIVITY

- ① NO CURRENT DRAIN  
PLUS
- ② SELF CALIBRATION

MODEL  
1250



## TRIPLET VACUUM TUBE VOLTMETER

★ Means Accuracy cannot be affected by the current drain of the instrument itself. No current drain in Triplet Vacuum Tube Voltmeter assured by self calibrating bridge circuit used.

★★ The most important advancement in circuit design for precision electrical measurements within recent years.

DEALER PRICE  
**\$33.34**

THIS IS A TRIPLET MASTER UNIT  
See your jobber—write for more information

All laboratories and engineers will immediately appreciate the significance of this remarkable instrument. Indispensable also in the servicing field for measuring electrical impulses either A.C. or D.C. of low magnitude such as the carrier wave of signal circuits, and particularly for television work.

The self-calibrating feature is automatic with the tube bridge circuit developed by Triplet Engineers (Pat. Pending). The initial operation of adjusting the bridge at the Zero level insures exact calibration

independent of tube emission values or when replacing tubes.

Model 1250 is furnished with Triplet Tilting type twin instrument. One instrument indicates when bridge is in balance. The other is a three range voltmeter with linear scales reading in peak A.C. and D.C. voltages. Ranges are 2.5, 10 and 50 Volts. Other Ranges to order.

Model 1250 is complete with all necessary accessories including 1-84, 1-6C6, 1-76. Case is metal with black wrinkle finish, panels are silver and black.

THE TRIPLET ELECTRICAL INSTRUMENT CO.  
239 Harmon Dr., Bluffton, Ohio

Without obligation please send me complete information on TRIPLET VACUUM TUBE VOLTMETER.

I am also interested in .....

Name .....

St. Address .....

City .....

State .....



# Save Chassis Space . . .

## with P. R. MALLORY & CO. Inc. MALLORY Standard Dry Electrolytic Capacitors

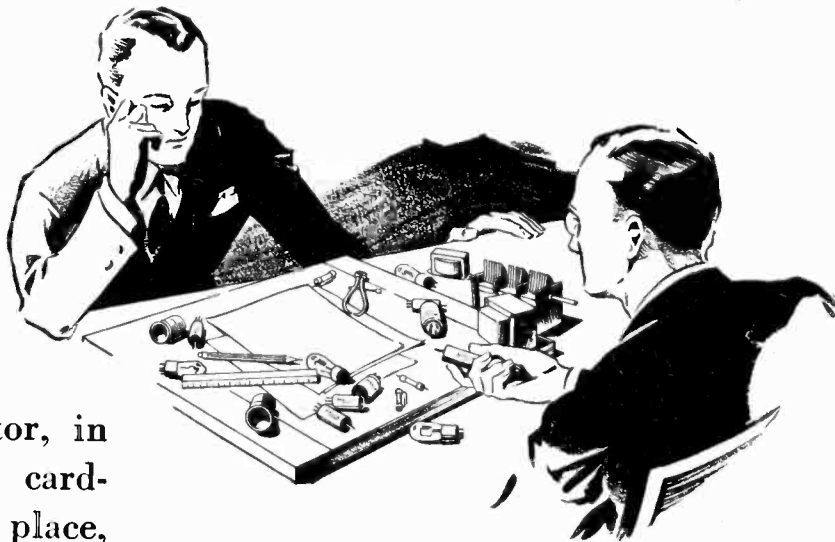

One Mallory Capacitor, in round metal can or cardboard tube, takes the place, in most cases, of *several* ordinary capacitors. Specify Mallory and use the capacitor space saved for other purposes — or to reduce the chassis size!

### Save Chassis Material Cost!

The selection of a new Mallory standard combination unit will reduce your present capacitor cost. Mallory's new method of standardization with lowered production cost makes this possible. In addition, extra cathode by-pass capacities may be included at slight additional expense.

### Save Production Time!

A *single* Mallory Capacitor, in most cases, completely fulfills your electrolytic capacitor requirements. Eliminate the punching of extra chassis holes—the buying or making of extra mounting brackets. New

Mallory units include concentrically wound combinations with as many as four sections.

Mallory Standard Capacitors are available in capacity and voltage combinations to fit your circuit. Let Mallory engineers help select the unit best suited to your needs.

*Mallory Capacitors provide exceptional safety with respect to high surge voltages as a result of a complete knowledge of the conditions imposed.*

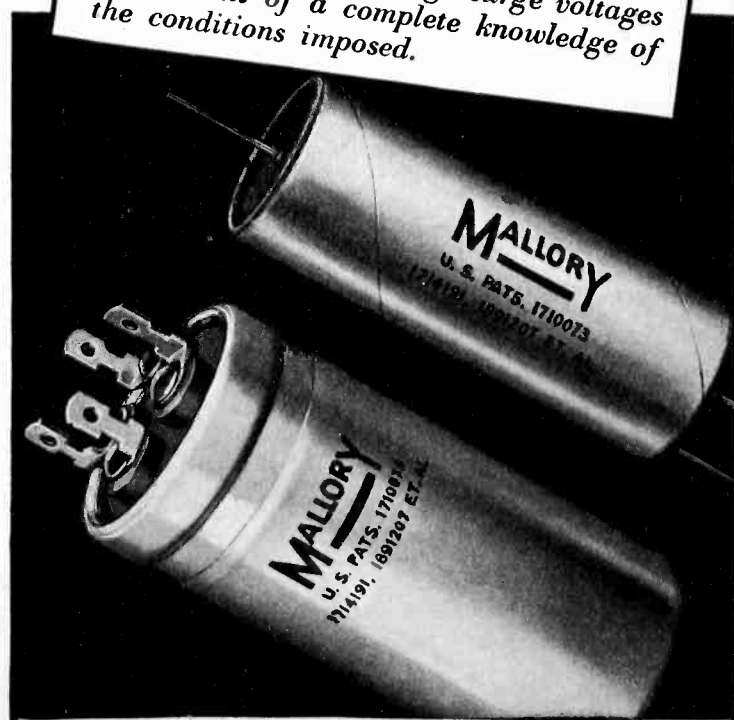

### Of Course!

CELLOPHANE SEPARATORS  
ETCHED ANODES  
STITCHED ANODE LEADS

— All recent important improvements pioneered or developed by Mallory — are incorporated in Mallory Condensers wherever they add to quality and utility.

P. R. MALLORY & CO. Inc.  
**MALLORY**

## DRY ELECTROLYTIC CAPACITORS

**P. R. MALLORY & CO., Inc., INDIANAPOLIS, INDIANA**

Cable Address — PELMALLO

# ELECTRONICS

SEPTEMBER  
1936

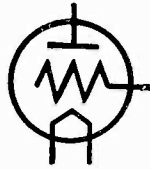

KEITH HENNEY  
Editor

## Crosstalk

► **WHOOPS FOR METAL TUBES . . .** A nationally known tube company in its annual report to its stock holders states with pleasant candor: "The operations of the Corporation and its subsidiary companies resulted in a net loss of \$90,434.17, the greater part of which was due to the development and sale of metal tubes, a situation made necessary by competitive conditions."

It would be extremely interesting and illuminating to get similar figures from the industry at large. No portion of the radio industry has experienced such financial discouragement as the makers of the tubes upon which that entire industry depends.

► **TUBE LIFE . . .** The following letter from C. O. Fairchild, Director of Research, C. J. Tagliabue Mfg. Company, Brooklyn, tells its own story.

"In Crosstalk for July you state that 'the editors will welcome comments' on the subject of the life expectancy of electronic equipment. We would like to furnish information from experience with two tubes which we are using, especially because you have quoted from one enthusiastic manufacturer who mentions 5,000 hours as a reasonable life. Our experience so far indicates that 15,000 or 20,000 hours would be more nearly an acceptable rating. Our company's pyrometers in which are used a phototube and amplifying tube have been on the market only a little more than two and one-half years but a number of these instruments have been in constant use over 20,000 hours without a failure of the electronic tubes. In these two and one-half years there has not yet been an electrical failure of any tube and only two mechanical failures.

"Of course we have obtained this long life by operating the tubes well below their rated capacities. It appears to the writer that such a policy is the only tenable one which can be pursued in the use of electronic devices for industrial purposes where reliabil-

ity is significant. We may add as interesting items that the rating for the light source which we are using is 10,000 hours and a primary relay has proven its ability to operate over 100,000,000 times without failure."

► **PARLOR GAME . . .** One of our engineer friends has developed a game which amuses him quite a bit. Whenever he has a few moments to spare he sits at his radio and jots down the number of channels on which there is good reception; the number on which there is tolerable reception (only partially mired up by other stations), the number of channels on which there are flutters and the number totally unusable.

He states that in Chicago in the Spring he found that there are about 6 channels on which he can get excellent service on a better than average receiver; in daytime there are 15 channels giving tolerable reception. At 7 p.m. there are about 21 tolerable channels and at 10 there are about 18. In this vicinity and time of year there are 28 flutters of more or less constant value.

The Editors will be interested in looking at the score card of any one taking a whack at this idle-moments game.

► **OSTRICHES . . .** In a midnight confab with a well known loud speaker engineer, not long ago, the following comments came out. Loud speaker manufacturers have learned how to make speakers with much greater harmonic distortion than was possible a few years ago. They can now take care of practically any demands of the set manufacturers. Synthetic bass is only one of their accomplishments. Apparent loudness is a trick they have developed within three years. It is comforting to note the progress in loud speaker engineering.

According to this engineer (of course, we don't believe this) it is not the public that decides what the public wants but the sales department of the radio companies. And so the public gets, not high fidelity sets, free from distortion, but a new jimcrack with a new and fancy name, red, white and blue (or non-metallic) screws, and a radio that sounds like the one they bought four years ago

► **DOG DAYS . . .** August may be dog days, but August saw Philco demonstrate the progress made in television. Newspaper men saw, in Bill Grimditch's home, black and white pictures sent from the factory 70 miles away. Engineers staged the first television popularity contest, the Philco quartette, a one-round bout on the factory roof, an interview with Boake Carter, a sport film. All was very clear, bright, steady, entertaining.

August saw tugboats in New York harbor ordered about from shore via Western Electric radio. Thus tugboat skippers come under the visa of the FCC, since they must possess a Third Class Radio Telephone operator's license.

August saw the stereophonic projection of Dr. Stokowski and an orchestra of 100 players over a vast audience by means of the Bell system first demonstrated by wire in 1933 in Philadelphia. ERPI commanded the services of Dr. Harvey Fletcher, W. B. Snow and A. R. Soffel, Bell Laboratories engineers, to transport the apparatus to Hollywood Bowl, and to operate it as Dr. Stokowski's condition to taking the contract. 28,000 people heard the concert.

August saw a Dun & Bradstreet report that radios were being made at a faster rate than at any other time in the industry's history. An average gain of 15 to 30 per cent in volume (units and dollars) is estimated. More auto sets were made in the first half than in all of 1935.

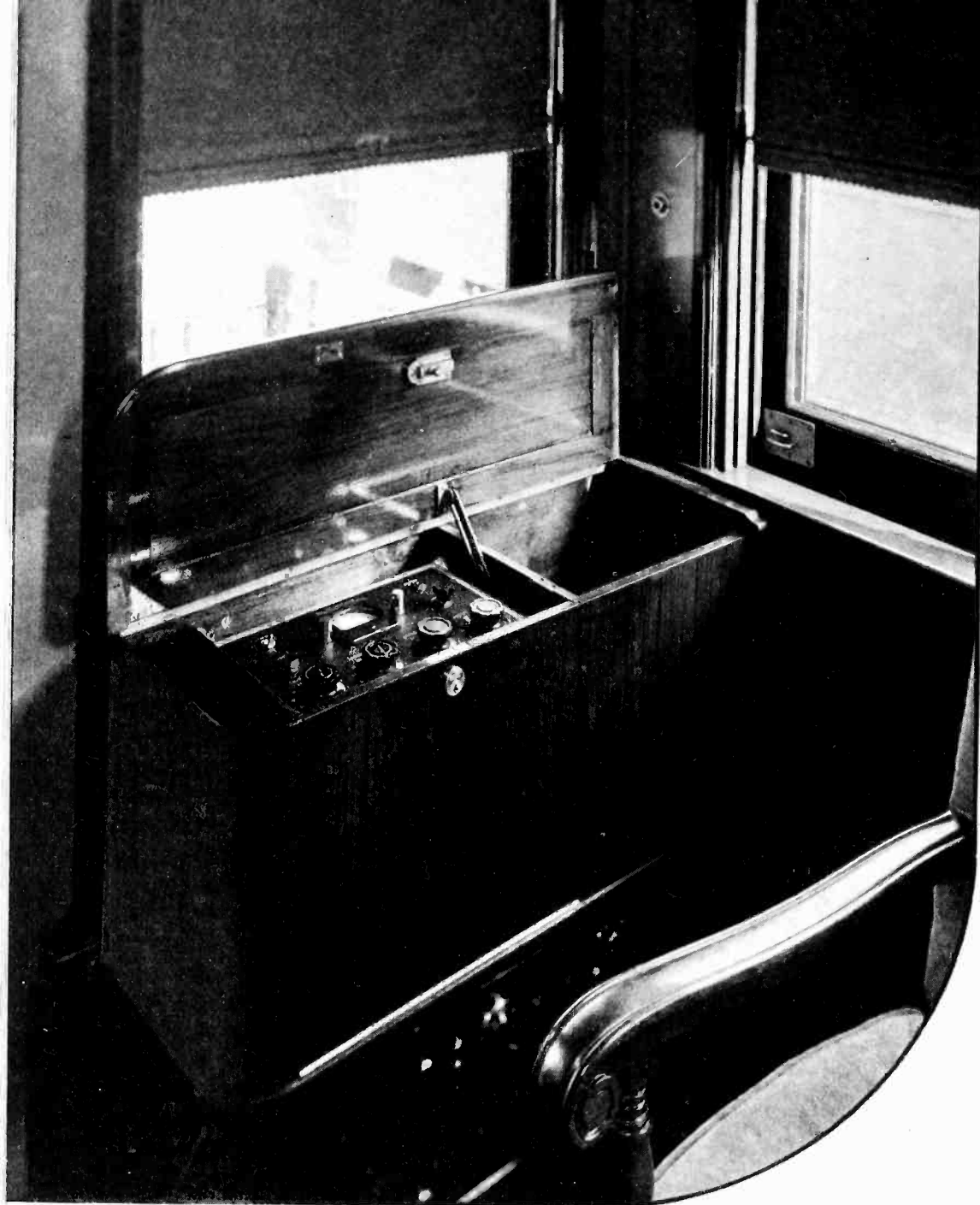

*Installation of amplifier equipment at rear of observation car. The pre-amplifier, with space for microphones and accessories, is housed in the cabinet, below which is the power amplifier*

**R**EALIZING the ever-increasing importance of radio and public-address services in the political arena, the Republican National Committee has engaged a staff of engineers and technicians for the duration of the Presidential Campaign. Heretofore political organizations have relied largely upon standard facilities afforded by the radio networks, local stations, and local public-address services. However, radio has become of such tremendous importance in campaigning that every detail must have thorough consideration so that the speaker's personality, as well as his words, may be projected to the unseen audience.

The acquisition of an engineering staff to assume responsibility for radio facilities and public-address services has resulted in several distinct advantages. In the first place

the equipment is engineered or "tailor-made" for each function thereby affording improved performance, greater flexibility and utility, and lowered costs through avoiding duplication of facilities. In addition, it results in rapid delivery and installation of equipment because a small group of men, abreast of the latest developments and trends and possessing suitable contacts in the industry, may obtain results more quickly than larger organizations. Finally, the staff of engineers can obtain operating efficiency and greater cooperation with broadcasters, news-reel men, etc., because the educating and training of a different group of people for each installation is not necessary.

A technical difficulty in transmitting speeches of widespread public interest is that of locating micro-

By H. A. RAHMEL

and

C. H. WARRINER

phones near the speaker's rostrum in order to supply the program to three or four radio-networks, several local stations, a number of news-reel cameras, and to the public-address service. This multiplicity of microphones inherently embodies several disadvantages. It obstructs the view of the audience and news-reel cameras. It impairs quality since the microphones are of necessity disadvantageously situated, due to total number which must be used. The effect of the speaker turning his head will influence certain microphones more than others. The type of microphone best suited to the speaker's voice may not be employed by the several organizations because they have not had opportunity to make tests necessary to determine the type ideally suited. In many cases the public-address microphone is relegated to the side (due to the preference accorded radio and camera microphones), with the result that the audience is poorly covered. Experience has shown that a poor public-address installation leads to the crowd's becoming restless and out of control, even voicing its objections to the extent that they are heard through the radio pick-ups.

These microphone difficulties have been surmounted by using one microphone and by designing equipment bays consisting of power-supplies, monitoring facilities, and 14 bridging-amplifiers arranged to operate (at zero-level) from the output of conventional remote or pre-amplifiers. These are used to supply programs at zero-level on 500-ohm terminations to radio-networks, local radio-stations, news-reel cameras, the public-address service, etc. The advantages of this scheme are obvious when considered in light of the difficulties outlined in the previous paragraph.

The bridging amplifier units consist of a single push-pull stage ar-

# Circuits for Politics

Broadcast stations, news-reel cameras, public address—all fed from a single system designed by the engineering staff of the Republican National Committee to project personality as well as words

ranged so that the failure of one tube has little effect upon performance. A spare or stand-by amplifier is included in each assembly so that a defective unit may be "patched" out. Similarly, a stand-by power supply may be cut in by throwing a toggle-switch. Each bay has a monitor panel which permits checking input and output levels and terminations on each amplifier.

An apparent disadvantage of this system lies in the fact that every service is supplied through one complement of apparatus, necessitating that it be failure-proof insofar as possible. Space will permit only a short description of the steps that have been taken to guard against the possibility of equipment and power failure. All facilities—microphone, remote or pre-amplifier, the 14-feed bridging-amplifier assembly, lines to each network, camera, etc., and the a-c power source are supplied in duplicate. Thus two entirely isolated systems supply program simultaneously on two lines to each broadcaster, camera-man, etc. The equipment is entirely a-c operated—each channel on individual, isolated feeds—from the city supply; but a complete conversion to battery operation on one channel may be made in about ten seconds.

## *Public Address*

Public address equipment had to be provided for sound-reinforcement for large crowds at major speeches such as at the Topeka and Chicago

*Front and rear views of one of the bridging amplifier units. Each contains fifteen separate amplifiers (one stand-by) and a monitor panel. Two units, containing 30 amplifiers in all, are in use to prevent any possibility of failure. A defective amplifier may be replaced by the stand-by unit by means of two patch cords*

notification ceremonies of Governor Landon and Colonel Knox, and for private car installations for rear-platform speeches from the Landon and Knox special campaign trains.

The first requirement was met by obtaining the services of a modern sound-truck owned and operated by one of the country's most experienced and competent operators. This sound-truck is equipped with two 100-watt amplifiers, a gasoline driven 60-cycle alternator (to be used where a-c power is not available) two 35-foot collapsible steel towers (quickly erected or demounted, usually at

either side of the speaker's platform) for support of the loud speakers; also microphones, radio-tuner, and accessories. A sufficient number of horns and directionally-baffled dynamic loud-speaker units are carried to permit mounting two tiers of speakers on the towers, thereby affording coverage of massed open-air audiences up to 200,000 people.

## *Rear-platform (train) Installations*

The objectives to be attained by railroad car installations may be realized from the demands to be made upon the equipment:

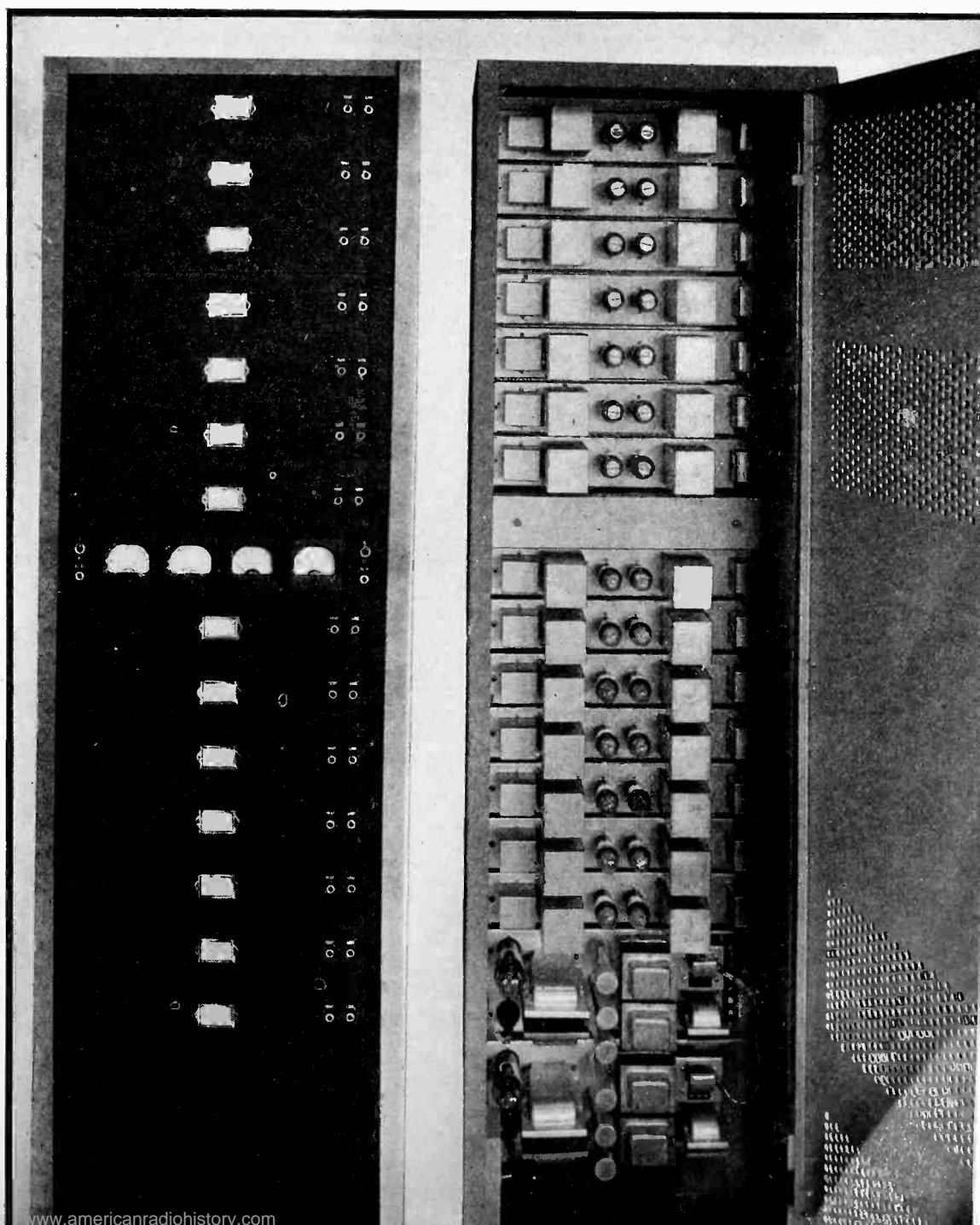

1. Adequate coverage for rear-platform crowds up to ten thousand people.

2. Program to be supplied to telephone lines (500-ohm termination at zero-level) for broadcasters (usually local stations).

3. Program to be supplied to news-reel cameras (at various levels and terminations).

4. Equipment to be quickly removable for installation at local halls should occasion demand.

5. Total weight of all equipment not to exceed 250 pounds in order that it be suitable for aeroplane travel.

These requirements were met by using a remote amplifier (of the type used to feed the bridging-amplifiers on major broadcasts) a resistive distribution network to supply the program to the broadcasters and camera men, two 40-watt power amplifiers, and a suitable loud-speaker system. For aeroplane travel the latter consists of two 25-watt 12-inch dynamic units baffled by a divided

carrying case. On the trains the loud-speaker system consists of four directionally-baffled dynamic units (25-watt, 12-inch); two are mounted in fixed positions to afford coverage to the rear of the train, and the remaining two are adjustable to afford coverage at any angle on either side.

Sixty-cycle power on the trains is obtained from 300-watt converters operated from the 32-volt train batteries. The amplifiers, distribution-box, accessories, and tools are compactly situated in a partitioned cabinet at the rear of the observation room of the private car. The entire installation may be placed in carrying cases ready for air transport or removal to a hall in about ten minutes. The total weight of the remote and power-amplifiers, portable loud-speakers, portable speaker's rostrum, distribution-network, microphones and accessories is less than 200 pounds.

#### *Performance Standards*

High performance standards have been maintained throughout. The

radio units — pre-amplifiers and bridging amplifiers — have  $\pm 0.5$  decibel variation in amplification from 30 to 15,000 cycles, and a total harmonic-distortion of the order of 0.5 per cent. The hum-level on a-c operation is more than 55 decibels below zero-level, and input and output feeds are balanced to ground.

The public-address equipment has similarly adequate performance characteristics: 1.0 decibel variation in amplification from 40 to 10,000 cycles with total harmonic-distortion less than 5 per cent. All units have been ruggedly constructed so as to withstand rough treatment in transit, and every attempt has been made to minimize equipment failure.

The remote or pre-amplifier was developed by the Collins Radio Company as a result of submitted specifications and data. It is unique in its field and has a number of unusual features: three universal input-channels permitting any type microphone to be plugged into each receptacle; high-level mixing; push-pull output stage; convenient access to every component and connection; unusually low hum and noise-level, and compactness and light-weight. The Republican Committee has obtained all units thus manufactured, but they are now being advertised for general sale. Collins Radio also constructed the bridging-amplifier assemblies and distribution networks to specifications.

The power-amplifiers used on the trains were constructed by the Remler Company, Ltd., in accordance with submitted specifications. They employ two of the new beam-power tubes in the output stages and accordingly develop ample power. They are compact, rugged, and easily portable. The amplifying equipment installed on the sound-truck was also supplied by Remler.

#### *Personnel*

The staff consists of the following men: Charles H. Warriner, in charge for the Republican National Committee; James D. McLean, operating engineer; Dean Bailey, B.A., operating engineer; Meyer Freeberg, design engineer; Robert C. Mulnix, owner of sound-truck; H. A. Rahmel, M.S., consulting engineer, on leave from the Department of Electrical Engineering, Massachusetts Institute of Technology.

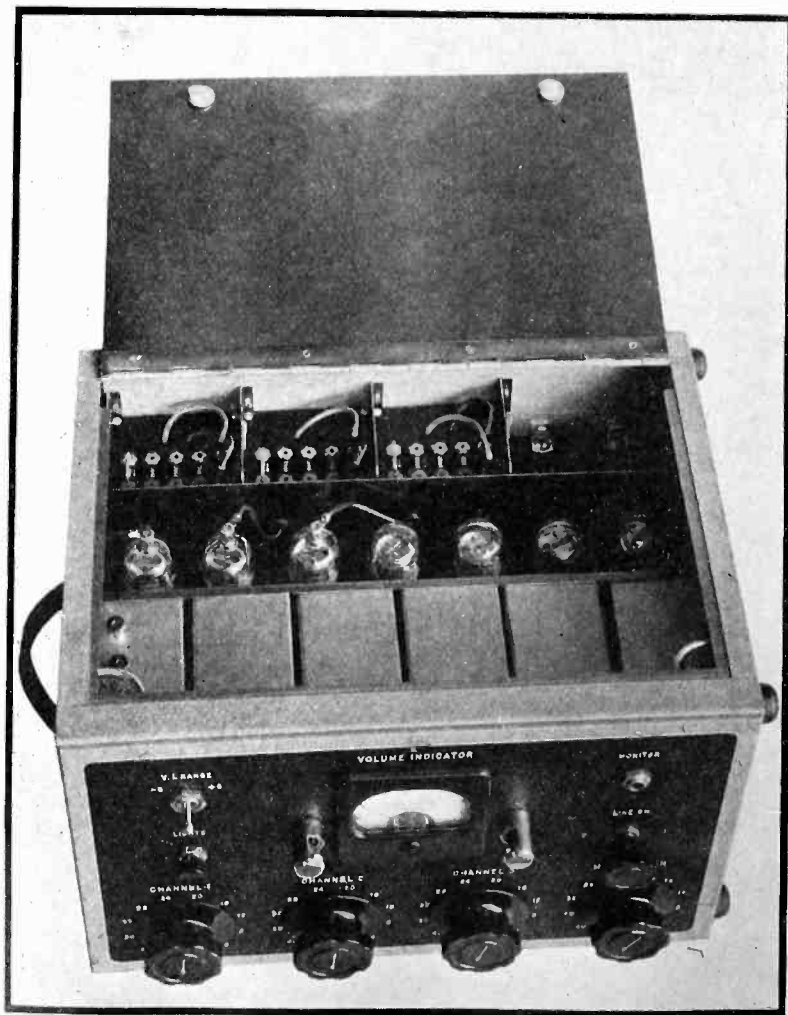

*Pre-amplifier unit with cover thrown back. The input connections at the rear readily permit changing microphone impedances. This amplifier feeds the fourteen bridging amplifiers which in turn supply the signal to the broadcasters, news-reel men, and public address system*



# Cathode Rays for the UHF

Correcting for electron transit time in cathode ray oscillographs permits accurate voltage measurements up to frequencies of 300 mc. A Worcester Polytech thesis

**R**ECOGNIZING the increasing importance of the ultra-high frequencies, engineers find themselves confronted with the necessity of making quantitative measurements on their equipment, particularly measurements of voltage, current, and power existing in the various circuits involved. At present the methods of making these measurements are limited in their extent, since the usual methods employed begin to incur serious discrepancies as the frequency of the alternating voltages and currents is increased above the value of 1 to 5 megacycles.

As a thesis project it was decided to investigate one phase of this problem, namely that of making voltage measurements at these ultra-high frequencies, and to show how they may be applied to the science as a whole. The cathode-ray tube was selected as an instrument for voltage measuring at these frequencies for several reasons, first, because it has very little effect on the circuit being considered on account of the relatively low capacity presented to the circuit, and second, because of its ease of calibration and of predicting its variations on theoretical grounds. It is proposed to use this instrument in a circuit similar to that of the well-known cathode ray oscilloscope, taking as a measure of the required voltage the deflection of the electron beam in this tube.

When alternating voltages of ordinary frequencies, both audio and radio, are applied to the deflecting plates of the tube, the voltage variation which takes place as each electron passes through the field is so small that it is possible to consider each successive electron as being acted upon by a field of constant strength (although of a slightly different strength for each successive electron). Thus, the electron which is given the greatest deflection is the one which passes between the plates at the instant that the voltage wave on the plates is at its maximum

BY LESTER L. LIBBY

Norwich, Conn.

value, and its deflection is essentially the same as the deflection it would have been given if there had existed on the deflecting plates a steady d.c. voltage of the same magnitude as the peak value of the alternating voltage wave. Thus it can be seen that at ordinary frequencies ( $f=0$  to  $f=10^8$  cps) the peak value of the deflection produced may be assumed to be proportional to the peak value of the applied voltage wave in the same proportion as that determined for the d-c calibration.

At frequencies of more than  $10^8$  cps, however, the variation of the voltage across the plates is taking place at so great a speed that the field acting upon each electron can no longer be considered to be constant, but is, rather, a variable quantity which has a different effect on the electron beam, and a correction must be applied to the observed deflection, (depending on the frequency, the velocity of the electrons, and the length of the deflecting-plates), in order to have the d-c calibration still hold true. This is called the "transit-time" correction factor.

## Electron "Transit-Time" Calculations

The method of obtaining this "transit-time" correction factor is shown in the following derivation and set of sample calculations, based on fundamental relationships and integral calculus. Referring to Fig. 1, let:

Velocity of electrons  $=v = \frac{dx}{dt}$  (constant)

$D$  = recorded screen deflection  $= K \frac{dy}{dx}$

$l$  = length of the deflecting-plates.

$t$  = time, in seconds.

$f$  = frequency, and  $\omega = 2\pi f$

Assume the voltage on the deflecting plates is  $e = E \sin \omega t$ , a sinu-

soidal voltage of maximum value  $E$  and frequency  $f$ . From Newton's Second Law,  $F = ma$  (or  $a = \frac{F}{m}$ ) we obtain the relation:

$$\frac{d^2y}{dt^2} = \frac{k_0 E \sin \omega t}{m} = k_1 \sin \omega t \dots \dots \dots (1)$$

where  $k_0$  is constant depending on units,  $m$  = mass of electron, and  $k_1 = \frac{k_0 E}{m}$  (arbitrarily causing the numerical value of  $E$  to be fixed for this derivation, and investigating effects due to changes in the frequency only).

Upon integrating (1) we get:

$$\frac{dy}{dt} = -\frac{k_1}{\omega} \cos \omega t + c_1 \dots \dots \dots (2)$$

Integrating (2), we get:

$$y = -\frac{k_1}{\omega^2} \sin \omega t + c_1 t + c_2 \dots \dots \dots (3)$$

We must now turn to practical considerations and note that the deflection  $D$  on the screen depends for the most part on  $\frac{dy}{dx}$  the slope of the electron beam as it leaves the field, and very little on the value of  $y$ , this being due to the "magnifying" properties of this arrangement. We know from experience at lower frequencies that the amount contributed to  $D$  by  $y$  is very small, so it is reasonable to assume that its effect may be neglected in the mathematical analysis; this assumption is borne out by later experimental results.

From equation (2), and from the relation  $v = \frac{dx}{dt} =$  a constant, we get:

$$\frac{dy}{dx} = -\frac{k_1}{v\omega} \cos \omega t + \frac{c_1}{v} = -\frac{k}{\omega} \cos \omega t + \frac{c_1}{v}, \text{ where } k = \frac{k_1}{v}.$$

We may rid ourselves of the constant of integration by evaluating between the limits  $t_1$  and  $t_2$ , and we get finally:

$$\frac{dy}{dx} = -\frac{k}{\omega} [\cos \omega t]_{t_1}^{t_2} \dots \dots \dots (4)$$

From here onward the treatment may be better approached from a physical rather than a mathematical point-of-view. We have seen that a

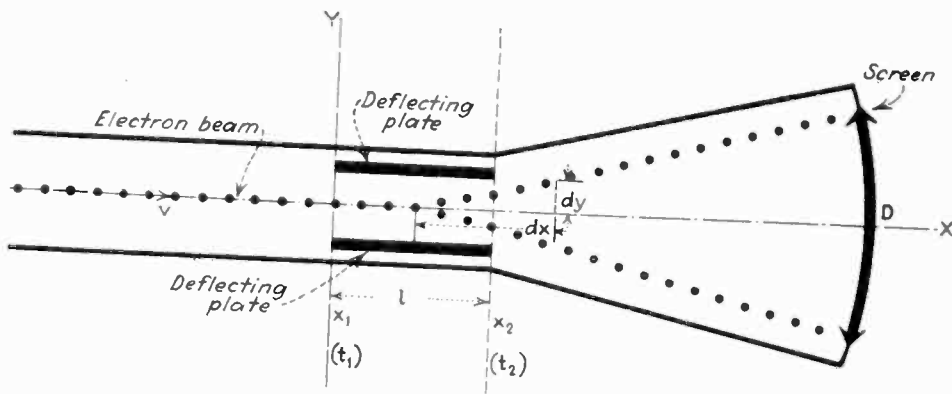

Fig. 1. Fundamental dimensions of the cathode ray tube showing path of electron beam

given electron will receive a maximum deflection when it is passing between the plates while the voltage on the plates is passing through its maximum value, i.e., through its  $90^\circ$  or  $270^\circ$  point. Now, with  $v$  constant, and the length,  $l$ , of the plates fixed, the time-interval  $(t_2 - t_1)$  is a fixed value. Therefore, the angle  $\omega(t_2 - t_1)$  is a fixed value, say  $d$ , for any given value of  $\omega$  (and therefore  $f$ ), and obviously the maximum value of the expression  $[\cos \omega t]_{t_1}^{t_2}$  occurs when  $\omega t_1 = (90^\circ - \frac{d}{2})$  and  $\omega t_2 = (90^\circ + \frac{d}{2})$ .

Now, making use of our assumption that the deflection  $D = K \frac{dy}{dx}$ , and knowing from experience that, for frequencies of  $3 \times 10^8$  cps ( $\lambda = 100$  meters), the  $D$  for a given  $E$  is the same as the  $D$  for that same value of  $E$  in a d-c voltage, we can, for any given cathode-ray tube with plates of any given size and an electron velocity of any given  $v$ , calculate the correction factor which must be applied at any given frequency. The following sample calcu-

lations show how this may be done.

Assume that we have a cathode-ray tube with deflecting plates 1 cm. in length and with 1000 volts d.c. on its anode No. 2, the anode which determines the velocity of the electrons in the beam. The electron velocity is given in this case by the expression: electron velocity  $= v = 5.97 \times 10^7 \sqrt{E_{b2}}$   $= 5.97 \times 10^7 \sqrt{1000} = 1.89 \times 10^9$  cm/sec. where  $E_{b2}$  is the voltage on anode No. 2. Now, since the deflecting plates are 1 cm. long, (effective), any given electron remains between the plates for a time of  $\frac{1}{1.89 \times 10^9}$  sec.,  $= 0.53 \times 10^{-9}$  sec.,  $= (t_2 - t_1)$ .

Now, suppose a voltage of maximum value  $E$  and of frequency  $f = 3 \times 10^8$  cps ( $\lambda = 100$  m.) is applied across the deflecting plates. Refer to Fig. 1. At this frequency  $d = \omega(t_2 - t_1) = (2\pi \times 3 \times 10^8)(0.53 \times 10^{-9}) \left(\frac{360^\circ}{2\pi}\right) = 0.58^\circ$  (electrical degrees)

Therefore from Equation (4)  $D_{100m} = K \frac{dy}{dx} = K(-k) \frac{\cos\left(90^\circ + \frac{0.58^\circ}{2}\right) - \cos\left(90^\circ - \frac{0.58^\circ}{2}\right)}{2\pi \times 3 \times 10^8} = K^1 \times (5.50 \times 10^{-10})$  cm., where  $K^1 = (K)(-k)$ .

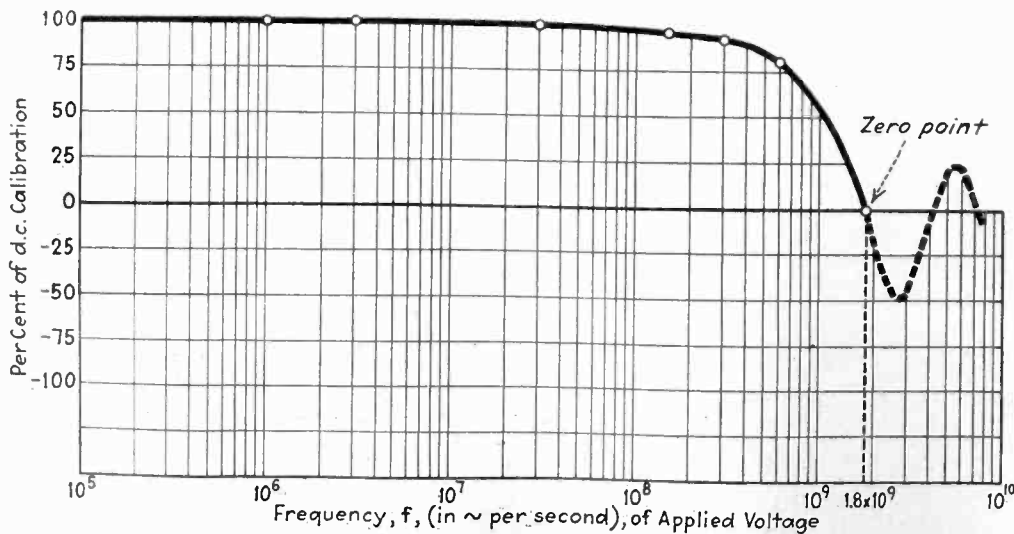

Fig. 2. Theoretical variation of response with frequency, showing zero response where the transit time is equal to a complete period of the wave

Now again, suppose we have a voltage of value  $E$ , and of a frequency  $f = 3 \times 10^8$  cps ( $\lambda = 1$  m.). At this frequency, we find that  $d = 58.0^\circ$  (electrical), and, calculating as above, we get:

$$D_{1m} = K^1 \frac{\cos\left(90^\circ + \frac{58^\circ}{2}\right) - \cos\left(90^\circ - \frac{58^\circ}{2}\right)}{2\pi \times 3 \times 10^8} = K^1 \times (5.13 \times 10^{-10}) \text{ cm.}$$

Using the 100 meter deflection as our reference value, we find that the corresponding 1 meter deflection is 93% of the value it should have on the basis of the d.c. calibration values, which means that the value of deflections obtained at this frequency are 7 per cent too small, requiring, therefore, a correction factor of 1.07 to be applied to this particular cathode ray tube at the particular frequency of 300 megacycles, when the voltage on anode No. 2 of the tube is equal to + 1000 volts with respect to the cathode.

Calculations for other frequencies were made in a similar manner to the above, and a curve showing the variation in response as a function of frequency was plotted for the case analyzed above. This curve (Fig. 2) shows that at a frequency of  $1.8 \times 10^9$  cps ( $\lambda = \frac{1}{6}$  meter), the visible deflection becomes zero, regardless of the magnitude of the applied voltage to the plates. This is the point, as can be seen from the mathematics, at which the angle  $d$  becomes  $360^\circ$ , or to put it differently, the point at which the electron transit-time becomes equal to the length of time of one complete cycle of the applied voltage wave.

#### Experimental verification of zero response

Regarding the point of zero deflection-response, it was thought that an experimental verification of this peculiar effect would constitute an excellent check on the mathematics and theory involved in the derivation. Since frequencies of the magnitude required could not possibly be obtained with the apparatus available, it was at first believed that this check could not be obtained. It was soon realized, however, that to obtain an angle  $d$  of  $360^\circ$  it was necessary merely to increase the electron transit-time and the required effect would take place at a lower frequency as a result of this. To in-

crease the electron transit-time, it is necessary merely either to increase the length of the deflecting plates or decrease the velocity of the electrons in the cathode-ray beam, or both.

With this in mind, a cathode-ray tube having plates of an effective length of 1.6 cm., (taking account of fringing at the edges of the plates), was obtained, an RCA Type 906 cathode-ray tube. It was found that this tube would operate with an anode potential of about 190 volts minimum to 1200 volts maximum. An ultra high-frequency oscillator was constructed, using an "acorn" tube, Type 955, in a circuit as shown in the schematic diagrams of the complete set-up on Fig. 4. The lowest wave-length at which this oscillator would function effectively was found to be 61 centimeters.

*Accelerating voltage reduced to limit transit-time*

Using this oscillator, connected so as to give a substantially constant input voltage to the plates of the cathode ray tube, it was found possible to verify the desired effect by the process of varying the anode potential on the tube (thus varying the electron velocity). The curve obtained of deflection as a function of anode potential for a constant deflecting-plate voltage of a constant frequency is shown above (Fig. 3), and it is interesting to note that the experimental results check the mathematically - calculated results very closely, in fact, within 5 per cent.

As shown by the above curve, the "zero" point occurs at an anode potential of 195 volts. The calculated figures indicated that the zero point would occur at 200 volts for this tube if a 60 cm. voltage-wave were applied, so that the maximum error is well within 5 per cent.

*Negative response not investigated*

It was found impossible to obtain the portion of the above curve indicated by the dotted line, since as was mentioned before, the cathode ray tube would not function at anode voltages of less than 190 v. However, it is believed that the results obtained are sufficiently conclusive to establish definitely the fact that this type of an instrument may be readily used as a means to determine

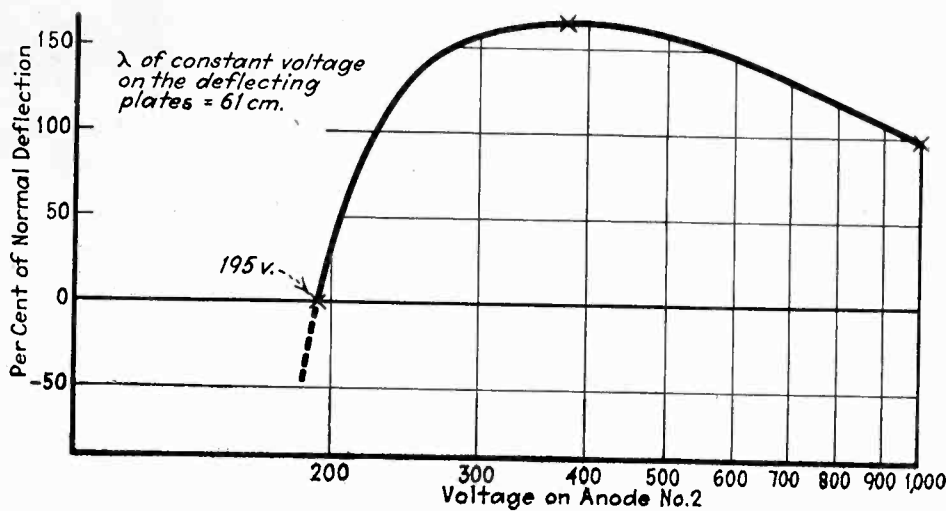

Fig. 3. Experimental curve showing response as accelerating voltage is reduced, thus shortening transit time

the value of voltages at ultra-high frequencies. It is proposed to use this type of instrument not to measure these voltages directly, but rather to calibrate some type of vacuum-tube voltmeter and use this instead. This method is suggested because the cathode-ray tube itself, plus its associated apparatus, is rather cumbersome to be readily portable.

A precaution which must be taken in making any measurements at these ultra-high frequencies is that the leads to the instruments are in themselves electrically-long lines, and so their effect on the circuits involved and on the instrument must be taken into account. This can be done in most cases quite easily, however, by the simple procedure of

using half-wave lines for connecting leads, and mathematically calculating the attenuation produced by such a line.

The writer wishes to express his appreciation to Professor H. H. Newell, for his helpful suggestions, advice and assistance in the theoretical and practical developments of this work, and to Professor R. K. Morley for his aid in the mathematical aspects of this same work.

**BIBLIOGRAPHY**

- The Cathode-Ray Tube at Work* by John Rider.
- Die Braunsche Rohre bei sehr hohen Frequenzen* by H. E. Hollmann, in the Sept., 1932, issue of *Hochfrequenztechnik und Elektroakustik*.
- The electron velocity formula was obtained from page 1319 of Volume 23, Number 11, *Proceedings of the I.R.E.* (Nov., 1935).
- Reference was also made to various pamphlets giving the static characteristics of cathode-ray tube, methods of connection for use as an oscilloscope, and the like.

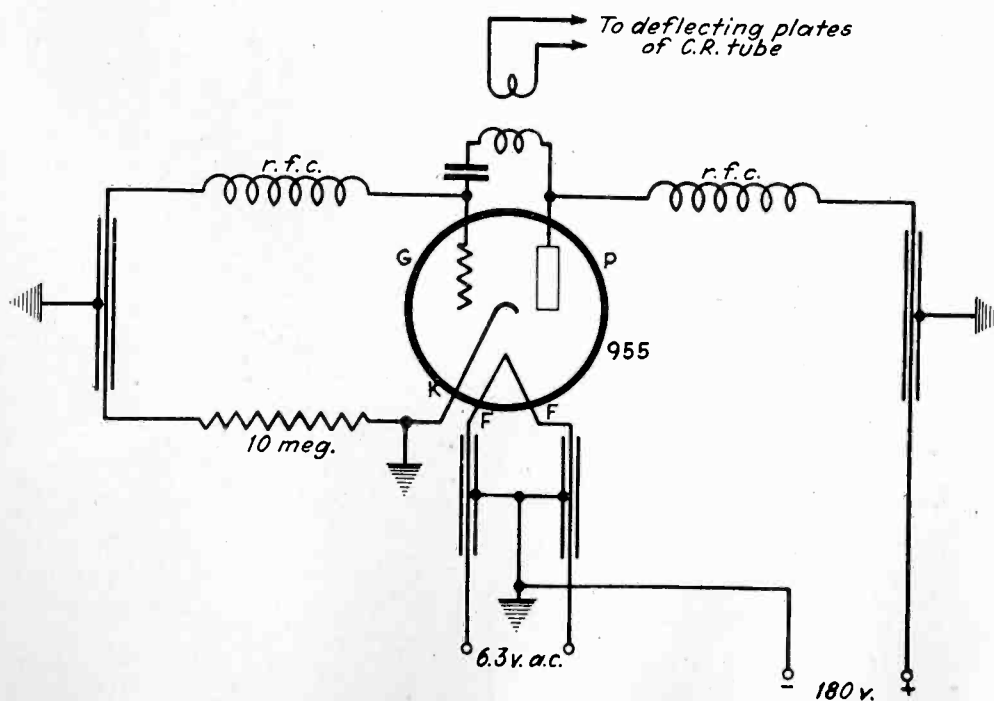
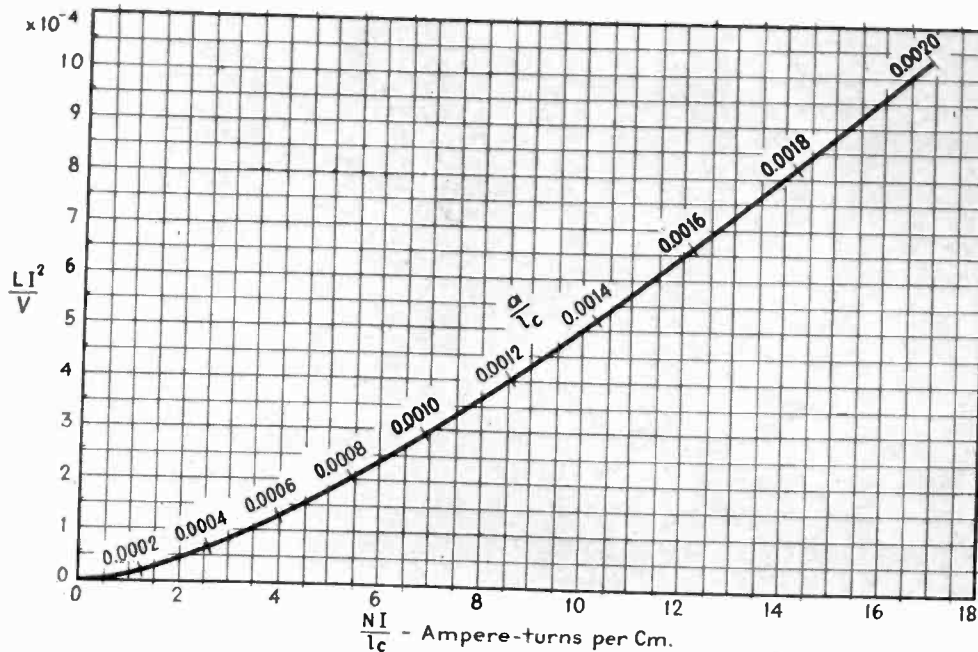

Fig. 4. Oscillator set-up for obtaining 60 centimeter waves used in testing zero-response. An acorn tube was used

# Reactors in

BY REUBEN LEE

Westinghouse Electric  
and Manufacturing Co.



**1** Fundamental reactor design chart for silicon steel. Dimensions used are shown in Fig. 2

**T**HE design of reactors carrying direct current—that is, the selection of the right number of turns, air-gap, etc.—was pretty much a cut-and-try art until 1927. In that year, a method was introduced by C. R. Hanna\* which simplified matters tremendously. By this method, magnetic data was reduced to a curve such as Fig. 1, plotted between  $\frac{LI^2}{V}$  and  $\frac{NI}{l_c}$ , from which reactors can be designed directly. The various symbols comprised in the coordinates are:

- $L$  = a-c inductance in henries
- $I$  = direct current in amperes
- $V$  = volume of iron core in cubic centimeters
- $= A_c l_c$  (ref. Fig. 2)
- $A_c$  = Cross-section of core in square centimeters
- $l_c$  = Length of core in centimeters
- $N$  = Number of turns in winding
- $a$  = Air-gap in centimeters

An example will show how easy it is to make a reactor according to this method. Assume a stack of iron having a cross-section  $\frac{7}{8}$  inch x  $\frac{7}{8}$  inch, and suppose the iron fills 92 per cent of this space. The measured length of the flux path in this core is  $7\frac{1}{2}$  inches. It is desired to know how many turns of wire and what air gap

\* A.I.E.E. Journal Feb. 1927, p. 128.

are necessary to produce 70 henries when 20 milliamps d-c are flowing in the winding.

This problem is solved as follows:

$$A_c = (.875)^2 \times (2.54)^2 \times .92 = 4.55 \text{ cm.}^2$$

$$l_c = 7.5 \times 2.54 = 19.05 \text{ cm}$$

$$\frac{LI^2}{V} = \frac{70 \times 4 \times 10^{-4}}{4.55 \times 19.05} = 3.23 \times 10^{-4}$$

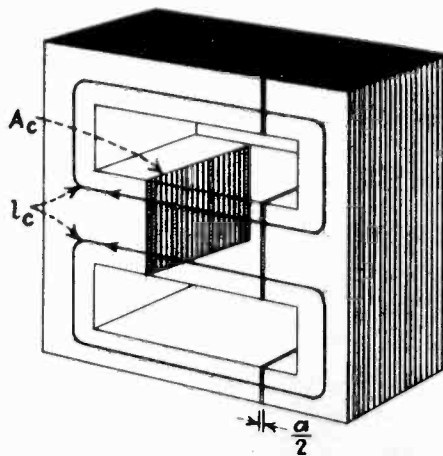

**2** Typical core structure showing dimensions used in reactor design

From Fig. 1 it is seen that  $\frac{NI}{l_c}$  is 7.5, and the air-gap is between .001 and .0012 times the core length.

$$\frac{NI}{l_c} = 7.5$$

$$N = \frac{7.5 \times 19.05}{.020} = 7150 \text{ turns}$$

The total air gap per leg is between  $.001 \times 7\frac{1}{2}$  and  $.0012 \times 7\frac{1}{2}$ , or 7.5 to 9 mils; the exact value is not of material consequence. The reason for this statement will appear later.

The curve of Fig. 1 is the envelope of a family of fixed air gap curves such as those shown in Fig. 3. These curves are plots of calculations based upon the assumption that the a-c flux in the iron core has a negligibly small value compared to the d-c flux. Each curve has a region of optimum usefulness, beyond which saturation sets in and its place is taken by a succeeding curve having a larger air-gap. A curve tangent to the series of fixed air-gap curves is that of Fig. 1, and the regions of optimum usefulness are indicated by the scale  $a/l_c$ . Hence Fig. 1 is a curve determined by the d-c flux conditions in the iron and represents the most  $LI^2$  or energy content for a given amount of material.

Figure 3 illustrates how the exact value of air-gap is of little consequence in the final result. The dotted curve connecting B and C, is for an intermediate value of gap, 6 mils. Point Y' represents the maximum inductance that could be obtained from a given core at this point by using a 6 mil gap. Point Y is the inductance obtained if a gap of either 4 or 8 mils is used. The difference in inductance between Y and Y' is 4 per cent, for a difference in air-gap of 33 per cent.

It should be realized here that the length of path of magnetic flux through the coil has two components: the air-gap  $a$ , and the length of the core  $l_c$ . In Fig. 1 these two components are handled separately,  $l_c$  in the scale of abscissas and  $a$  in the scale plotted along the curve. The two components do not add directly because their permeabilities are different. In the air-gap, of course, the permeability is unity, while in the core it has a value depending upon the degree of satura-

# D-C Service

Methods, applicable to small units as well as large, for designing and rating iron-cored audio reactors in terms of the steady direct current they must carry

tion of the iron. Fig. 4 shows the permeability for a typical high-grade silicon steel. The *effective* length of the magnetic path is  $a + l_c/\mu$ , for the steady or direct current component of flux.

The curve in Fig. 4 marked  $\mu$  is the normal permeability of the iron for a steady value of flux—in other words, for the d-c flux in the core. It is quite different, however, from the permeability for small alternating fluxes superposed upon this steady value. The latter is marked  $\mu_\Delta$  in Fig. 4, and it is known as *incremental* permeability. The a-c inductance of the reactor is determined by the length of the a-c flux path and hence, to a large extent, by the incremental permeability.

The distinction between  $\mu$  and  $\mu_\Delta$  is made clear by referring to Fig. 5, which shows the top half of a typical hysteresis loop. The direct current in the winding fixes the steady magnetizing force  $H_{dc}$ , to which corresponds a flux density  $B_{dc}$ . A small alternating voltage across the reactor causes a superposed increment of flux  $\Delta B$  to alternately add to and subtract from  $B_{dc}$ , following the small hysteresis loop which touches the large loop at point *E* and the normal magnetization curve at point *F*. The incremental permeability is  $\Delta B/\Delta H$  and is represented by the slope of the line *AA*. It will be seen that *AA* has a slope much less than that of the normal magnetization curve at point *O*. Also, the smaller  $\Delta B$  is, the flatter the line *AA* becomes and consequently the smaller the value of permeability  $\mu_\Delta$ .

Because of this low value of  $\mu_\Delta$  for minute alternating voltages, the effective length of magnetic path  $a + l_c/\mu_\Delta$  is considerably greater for alternating than for steady flux. But the inductance varies inversely as the length of a-c flux path. If, therefore, the incremental permeability is small enough to make  $l_c/\mu_\Delta$  large

compared to  $a$ , it follows that small variations in  $a$  do not affect the inductance much. This is the reason that the exact value of the air-gap is not important.

The conditions assumed by the foregoing method of design are met in most radio applications. In receivers and amplifiers working at low audio levels, the a-c voltage is small and hence the alternating flux is small compared to the d-c flux. Even if the a-c voltage is on the same order as the d-c voltage, the a-c flux may be small. This is true if a large number of turns are necessary to produce the required inductance; for a given core the a-c flux is inversely proportional to the number of turns.

Because of the fact that Hanna's method applies to the majority of practical cases, and because of its simplicity, it is a justly famed and universally used piece of engineering. Before its publication, almost all reactor design was experimental, or cut-and-try.

## Use With Large Reactors

With the increasing use of higher

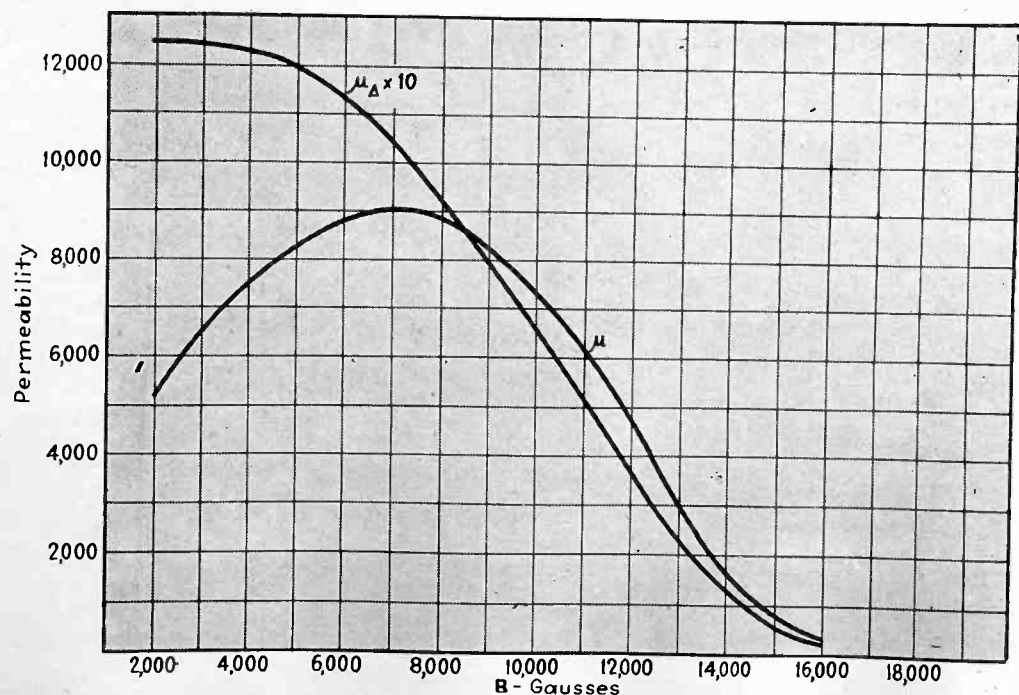

4 Normal and incremental permeabilities for silicon steel

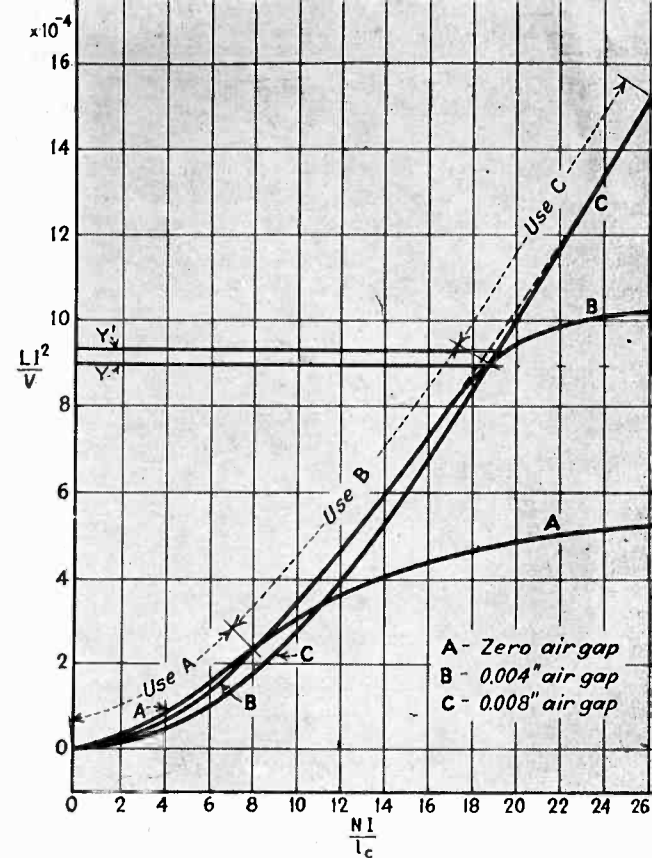

3 The envelope of several magnetization curves for different air gaps gives the maximum energy per unit volume (cf. Fig. 1)

audio power, necessitating larger sizes of reactors and transformers, it often happens that the a-c flux is no longer small compared to the d-c. This is especially true in high impedance circuits, where the direct current has a low value and the alternating voltage has a high value.

To illustrate the effect of these latter conditions, assume a reactor has already been designed for negligibly small alternating flux (that is, according to Fig. 1), and operates as shown by the small loop of Fig. 5. Without changing anything else, sup-

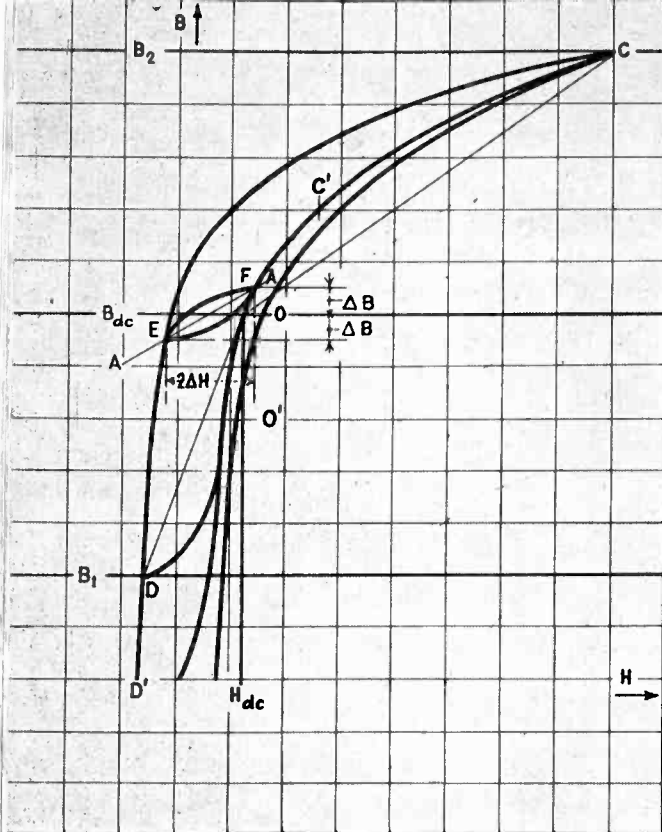

**5** Hysteresis loops for d-c reactors

pose the alternating voltage across the reactor is greatly increased, so that the total a-c flux change is from  $B_1$  to  $B_2$ . The reactor still operates about point  $O$ . The hysteresis loop, however, becomes the unsymmetrical figure  $CFDEC$ . The average permeability during the positive flux swing is represented by the line  $OC$ , and during the negative flux swing by  $OD$ . The slopes of both  $OC$  and  $OD$  are greater than that of  $AA$ ; hence, the first effect exhibited by the reactor is an increase of inductance.

The increase in inductance is non-linear, and this has a decided effect upon the performance of apparatus. An inductance bridge measuring such a reactor at the higher a-c voltage would show an inductance corresponding to the average slope of lines  $OD$  and  $OC$ . But if the reactor were put in the filter of a rectifier, the measured ripple would be higher than a calculated value based upon the bridge value of inductance. This is because the positive peaks of ripple have less impedance presented to them than do the negative peaks, and hence they create a greater ripple at the load. Suppose, for example, that the ripple output of the rectifier is 500 volts, and this would be attenuated to 10 volts across the load by a linear reactor having a value of inductance corresponding to the average slope of lines  $OC$  and  $OD$ . With the reactor working as indicated by Fig. 5, the slope of  $OD$  is five times that of  $OC$ . Consequently, the ex-

pected average ripple attenuation of 50:1 actually becomes 16.7:1 for positive flux swings, and 83.3:1 for negative, and the load ripple is  $\frac{1}{2} \left\{ \frac{500}{16.7} + \frac{500}{83.3} \right\} = 18$  volts, or an increase of nearly 2 to 1 over what would be anticipated from the measured value of inductance.

Turning to modulation chokes and transformers, assume that in Fig. 5, Curve  $CFDEC$  represents the operation of such a component. The reactive current drawn from the modulator tubes at low audio frequencies may be well within reasonable bounds for negative peaks of modulation, but may be high enough at positive peaks to cause an excessive amount of low-frequency distortion. This may be confirmed by comparing the change in  $H$  (which is a measure of reactive current) on both sides of point  $O$ ; the positive peak current is five times as great as the negative peak current.

This high positive peak current could be reduced to a value approaching the negative peak by increasing the air-gap somewhat, and thereby reducing  $H_{dc}$  so that it passes through point  $O'$ . Now  $B_1$  and  $B_2$  drop down so as to intersect  $D'$  and  $C'$  respectively. Moreover, the average permeability has increased, and so has the inductance. It will be apparent that to decrease  $H_{dc}$  further means another increase in a-c permeability—approaching in value the d-c or normal permeability. As a matter of fact, this is what a good design of modulation reactor involves: keeping the a-c permeability

high for both positive and negative modulation peaks. This can be done only if the maximum flux density is kept low enough to avoid the saturating effects represented by point  $C$  in Fig. 5. Conversely, it follows that if saturation is present in a reactor, it is manifested by a decrease in inductance as the direct current through the winding is increased from zero to full load value.

In a reactor having high a-c permeability the equivalent length of core  $l_c/\mu$  is likely to be small compared to the air-gap  $a$ . Hence, it is vitally important to keep the air-gap close to its proper value in modulation components. This is, of course, in marked contrast to reactors not subject to high a-c voltages.

If a modulation choke is to be checked to see that no distortion-producing saturation effects are present, access must be had to an inductance bridge. With the proper values of alternating voltage across the reactor, measurements of inductance can be made with various values of direct current through it. If the inductance remains nearly constant up to normal direct current, no saturation is present, and the reactor is suitable for the purpose. If, on the other hand, the inductance drops considerably from zero d-c to normal d-c, the reactor very probably is a distortion producer. Increasing the air-gap slightly may improve it, otherwise it should be discarded in favor of a reactor which has been correctly designed for the purpose.

The fact that the inductance is

[Continued on page 76]

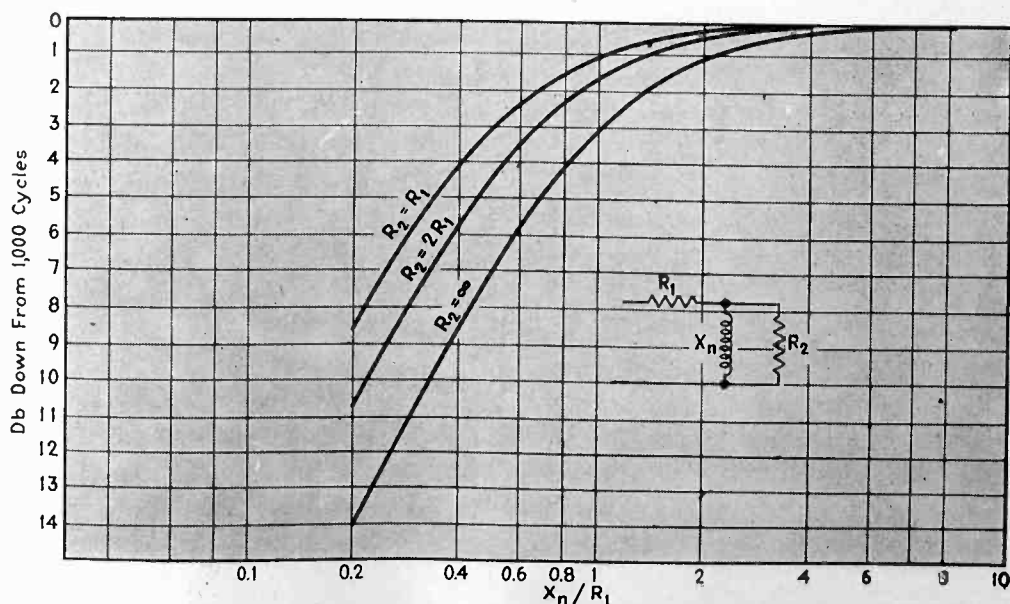

**6** Transformer characteristics at low audio frequencies

# A Static Velocity Microphone

---

A new and simple construction uses parallel dural ribbons and a perforated plate to produce velocity characteristics in a capacity-type microphone. Output -53 db

---

**T**HE microphone department of the entertainment and communications industries has for some years been one of the most active in developing new instruments and new competitive methods of rating their output. The former activity is entirely commendable, the latter perhaps less so, but together they have conspired to make microphones a topic of interest to nearly every engineer connected with sound transmission. The latest development in the field, to the editors' knowledge, is a new principle of construction applied to capacity microphones, which at once makes them much cheaper to manufacture and vastly easier to use in practice. The new microphone, called the "Velotron" by its inventor William A. Bruno of the Bruno Laboratories, New York, is of extremely simple construction, and it possesses several unusual technical features, particularly a high-frequency response which can be changed electrically from a remote location.

Fundamentally the new microphone combines the principles of the

*Microphone with cover removed, showing perforated valve which acts as one element of the electrostatic system*

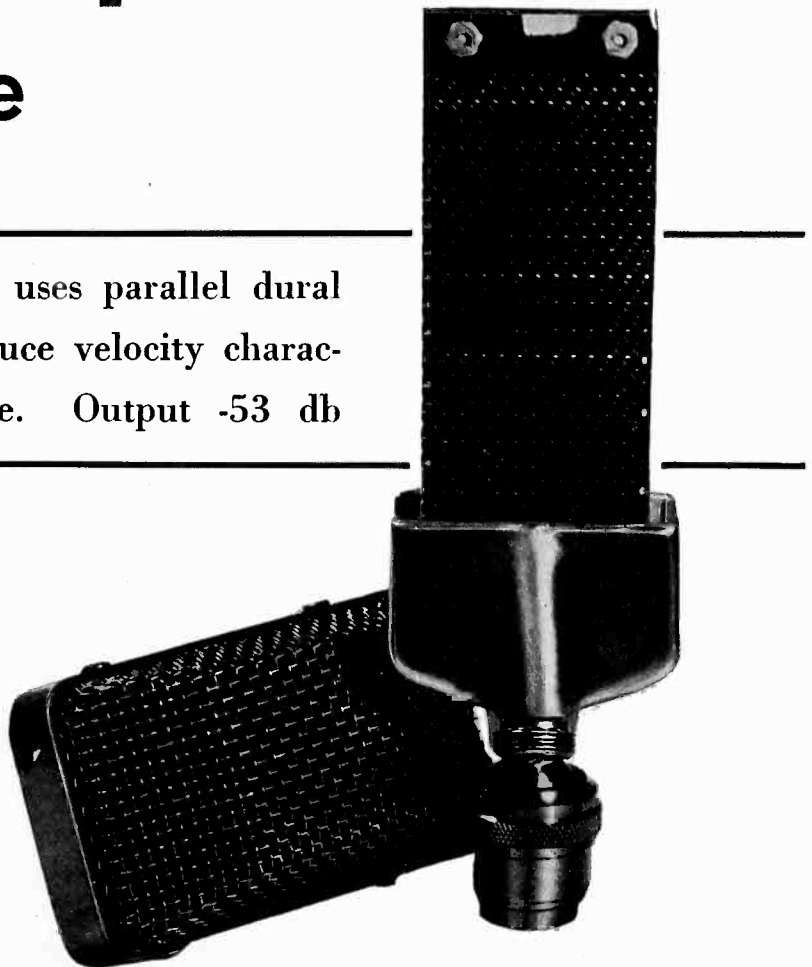

ribbon microphone and the condenser microphone. It consists of a flat insulated perforated plate, covered with a system of ribbons. The plate contains about 80 holes per square inch, each  $\frac{1}{16}$  inch in diameter. The insulation is applied in six coats, and the materials used are chosen to produce high insulation strength, especially at the sharp edges around each hole. Over the plate are laid eight ribbons (each 0.0002 inch thick) of duralumin, parallel to each other, with adjacent edges barely touching. The ribbons are fastened at their ends to the plate, are free

to move loosely toward or away from it. The ribbons act as one "plate" of the condenser microphone, the insulated plate as the other. The ribbon structure is protected by covering it with a second perforated plate similar in general appearance to the first but not so carefully insulated.

The principle of operation is as follows: A polarizing voltage of from 50 to 350 volts is applied between the electrodes; this voltage may be fed to the microphone over the same conductors which take the signal from it, and is applied through a ten

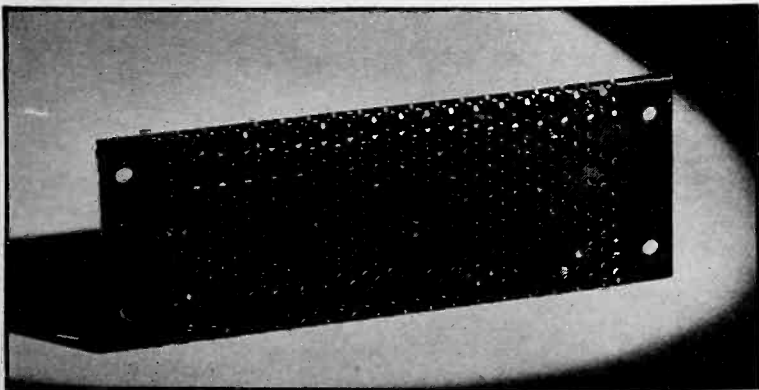

*The perforated plate must be carefully insulated to prevent breakdown under the effects of the polarizing voltage*

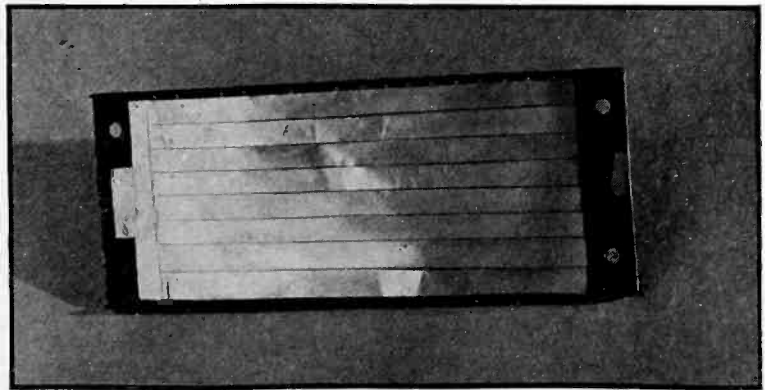

*These eight dural ribbons move in response to the sound pressure gradient, giving velocity response*

megohm resistor. Due to the fact that there is practically no current drawn by the microphone, filtering of the polarizing voltage is very easily accomplished and the circuit shown in the figure usually gives sufficient filtering even when the voltage is taken directly from the output of the rectifier unit, without passing through the usual filter sections. The leakage current through the microphone is extremely small, considerably less than one microampere. The effect of the difference of potential is to draw the ribbons against the perforated plate, with an attraction which depends directly on the value of the polarizing voltage. When the sound pressure gradient acts on the ribbons they move slightly with respect to the perforated plate, thus changing the capacity of the system. This change in capacity produces a corresponding variation in the charge drawn from the polarizing circuit; the resulting current produces a voltage change across a high resistance (5 to 50 megohms) connected in series with the microphone, and this voltage change affects the grid of the amplifier. The use of a large surface area in the unit (4 x 1½ inches) gives a large overall capacity, with resulting high signal level. Each perforation in the plate, together with the part of the ribbon immediately behind it acts as a contributing cell, the overall output being the sum of all the active cells acting in phase.

Several difficulties were encountered in the development. High output level was the first; operating stability the second. One of the most difficult problems was securing insulation between the capacity members which would withstand the effects of moisture. Even small

variations in leakage resistance in a ten megohm circuit can cause extremely troublesome noise levels. This problem has been solved by the use of proper insulating compounds; the noise level is far below signal output.

The microphone operates on the velocity principle, that is, on the difference in sound-pressure existing on the two sides of the ribbons, although there is probably also a small output due to pressure-type response. That the response is predominantly velocity-type is shown by two tests: the first is that the microphone has marked directional properties, the angle of response being somewhat broader than that of a magnetic-type velocity unit, but still very well marked. The second is the marked change in response which occurs when the side of the microphone away from the speaker is blocked in any way.

The output of the unit at the present stage of development is -53 db, or approximately the same as that of a diaphragm-operated crystal microphone. The signal output is considerably higher than that of magnetic-type velocity microphones. The frequency response is, to the ear, approximately the same as that of a good magnetic velocity unit, when moderate polarizing voltages and cable lengths of less than 100 feet are used.

The microphone is, of course, a high impedance unit, working directly into the grid of the first amplifier tube. This fact makes the use of long lengths of cable connecting the microphone to the amplifier an obvious problem, the same problem in fact which made the use of head amplifiers imperative with conventional condenser micro-

phones. That the problem still exists in the new microphone cannot be denied, but neither can the fact that the new unit can be operated with four hundred feet of shielded cable between the microphone and amplifier. This remarkable performance has been obtained in several ways, first by making use of the high output signal level, and second by accentuating the high frequencies, which the capacity of the cable tends to attenuate. The high frequency "boosting" is accomplished by the use of a high value of polarizing voltage (about 350 volts) which attracts the ribbons to the perforated plate with great force, restricting wide-amplitude motions at low frequencies and allowing small-amplitude high-frequency motions to occur with comparative ease. By changing the polarizing voltage, the high frequency response can be regulated in this manner by remote control.

The fact that the action of the microphone is electrostatic permits easy cable shielding and makes hum pick-up from electromagnetic fields very small. In fact the microphone and cable can be laid directly on the power transformer of the amplifier unit without audible hum pick-up. This treatment would completely paralyze magnetic units, as many of their users will testify, since magnetic shielding is difficult.

Being a high-impedance unit, the microphone is not intended for use in the broadcast field, where low impedance devices are usually required. But for public address and sound system use, where low impedance units are impractical from a cost and operation standpoint, the new microphone should prove to be of considerable value.

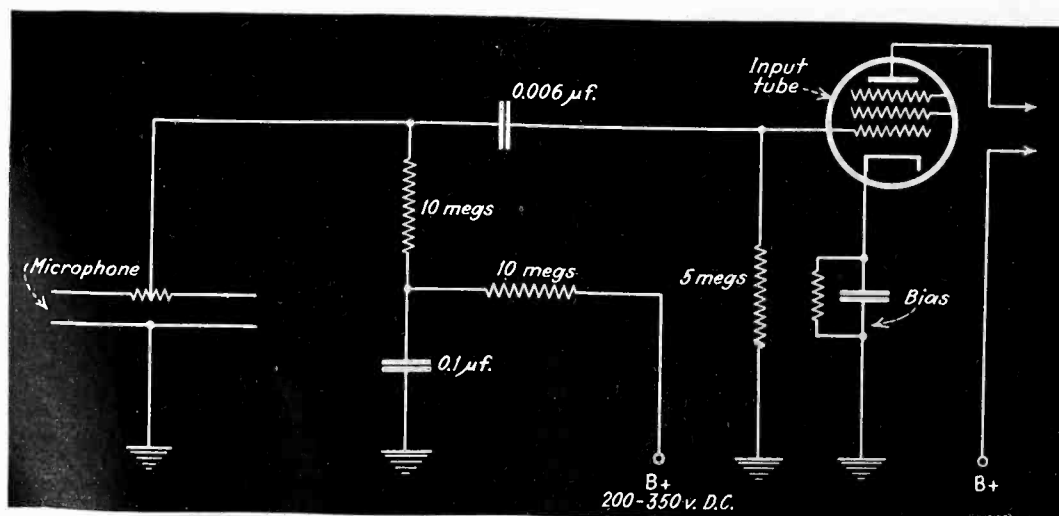

*Input connections of the static velocity microphone. The polarizing voltage may be obtained from any point in the power supply*



# Sommerfeld's Formula

Simplifications to the Sommerfeld formula (field strength at a distance from a broadcast frequency transmitter) which make it easier to work with and which do not introduce appreciable error

BY WILLIAM A. FITCH

National Broadcasting Company  
New York City

**P**RIOR to 1930 the Austin-Cohen formula had been in general use for studies of radio transmission. The formula has the advantage of simplicity but was found to be inaccurate for predicting field strengths at a distance, especially for high frequencies, or even medium frequencies over poor soil.

At about this time a number of papers began to appear dealing with the Sommerfeld formula and results were shown that agreed much more closely with actual measurements than the Austin-Cohen formula. However, the use of Sommerfeld's theory has not been widespread due probably to these two reasons: first, the Sommerfeld formula itself is not as simple as the convenient exponential Austin-Cohen formula. Second, Sommerfeld uses an extra variable which he calls  $\epsilon$ , representing the inductivity or dielectric constant of the soil.

It is the purpose of this article to point out certain simplifications which may be used with the Sommerfeld formula without introducing an appreciable error, and to present propagation curves and charts based on these simplifications.

The dielectric constant of soils in this country varies all the way from 5 to about 30. The dielectric constant of water is 80. A good average for most of the soil in the country is 14. This has been used for the charts presented in this article. The error introduced is not of much consequence if only broadcast frequencies are considered.

The other simplification consists of the elimination of  $\sigma$  (which represents the soil conductivity) as a variable. This may be done if we pick some standard of conductivity and refer all other conductivities to the standard by simply changing the frequency according to the following formula:

$$f_1 = f\sqrt{\sigma/\sigma_1}$$

$f$  = operating frequency  
 $\sigma$  = standard conductivity of chart (assumed to be  $100 \times 10^{-15}$  EMU)  
 $\sigma_1$  = actual soil conductivity  
 $f_1$  = conversion frequency

This formula has been plotted in the form of a chart and is shown in Fig. 1. Its use is best explained by an example:—If we wanted to find the conversion frequency for a soil constant of  $50 \times 10^{-15}$  EMU and an operating frequency of 700 kc.,—Referring to Fig. 1 we see that a frequency of 1000 kc. and soil constant of  $100 \times 10^{-15}$  EMU is equivalent to 700 kc. and a soil of  $50 \times 10^{-15}$  EMU. A similar chart has previously been prepared by Eckersley<sup>1</sup>, but he used the wavelength instead of frequency as the parameter.

Figure 2 shows a field strength-versus distance chart for a family of frequencies from 300 kc. to 3000 kc. It is based on a standard conductivity of  $100 \times 10^{-15}$  EMU and dielectric constant of 14 ESU and inverse field strength at one mile of 1000 millivolts. The actual calculation of such a chart has been described in previous papers and the method followed was that outlined by Rolf<sup>2</sup>. The error pointed out in Rolf's curves by K. H. Norton<sup>3</sup> was cor-

rected. Beyond about 150 miles for the low frequencies and about 60 miles for the high frequencies, it is necessary to include an earth curvature correction because Sommerfeld's theory is based on a flat earth. G. N. Watson<sup>4</sup> and others<sup>5</sup> have calculated the effect of earth curvature assuming a perfectly conducting sphere but little has been published on the effect of imperfect conductivity over spherical earth. The earth curvature correction used for the curves in Fig. 2 is based on actual field intensity surveys of stations. The dotted lines near the bottom of the curves were made to indicate that in this region an indirect ray is received in the daytime which causes a slight fading.

An investigation shows that the maximum error involved in using this one family of curves for all soil constants occurs when the conversion formula is used for very poor soils. About the poorest soil that will be found in the United States is  $20 \times 10^{-15}$  EMU. This occurs along the Atlantic seaboard. The error incurred in using  $100 \times 10^{-15}$  EMU instead of the exact value is slight. It is expressed on a percentage basis in Fig. 3. It is seen that when using the conversion formula for soils having a conductivity of  $60 \times 10^{-15}$  EMU the error is less than 5%. For soils between  $60 \times 10^{-15}$  EMU and  $100 \times 10^{-15}$  EMU the error will be

The Sommerfeld Formula:

"A" is the attenuation factor as given by Sommerfeld in *Ann. der Physik*, 81, 1926.

It is to avoid the necessity of using this highly complicated expression that the curves of this article have been prepared

$$A = \left| 1 - 2\sqrt{p_1} e^{-p_1} \int_{i\infty}^{\sqrt{p_1}} e^{-\omega^2} d\omega \right|$$

where  $p_1 = p e^{ib}$

$$p = \frac{\pi}{x} \frac{r}{\lambda} \cos b = \frac{\pi}{\epsilon + 1} \frac{r}{\lambda} \sin b$$

$$x = 1.8 \sigma \cdot 10^{18} / f_{kc}$$

$$\tan b = (\epsilon + 1) / x$$

FIG. 2 - Attenuation curves for soil having conductivity of  $\sigma = 100 \times 10^{-15}$  E.M.U. and inductivity of 14 E.S.U. inverse field strength at one mile = 1,000 Mv.

FIG. 1 - Conversion chart for soils other than  $\sigma = 100 \times 10^{-15}$  E.M.U.

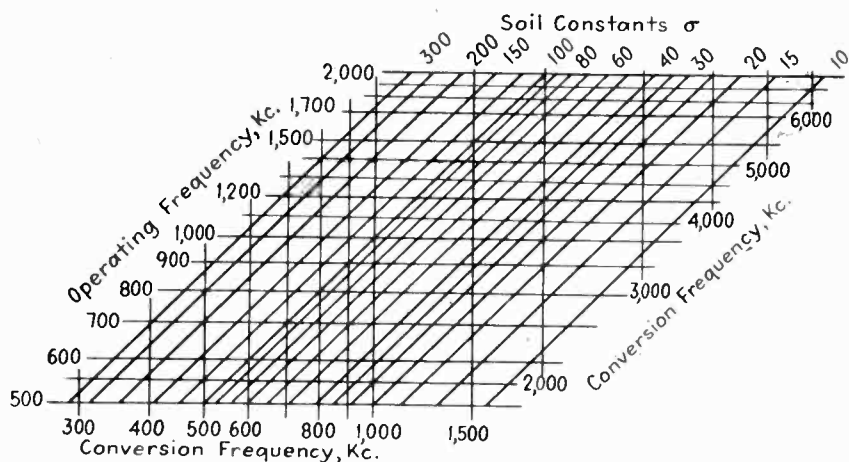
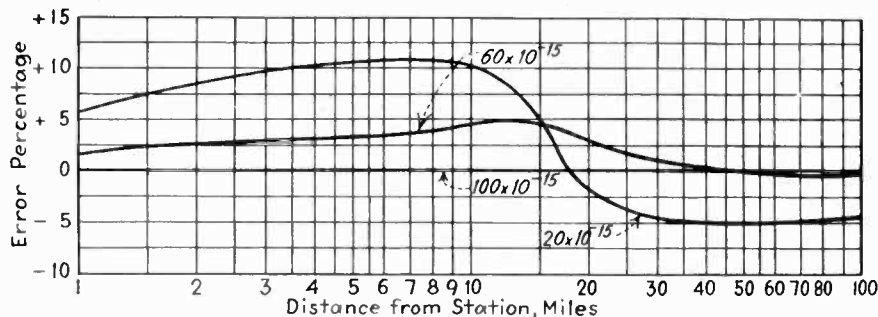

FIG. 3 - Error involved in using simplified method for soils having different conductivity than  $100 \times 10^{-15}$  E.M.U.



even less. A maximum error of about 11% occurs when using the conversion formula for soils having a conductivity of  $20 \times 10^{-15}$  EMU. Even here the maximum error is restricted to the first 15 miles. Beyond 15 miles the error is less than 5%.

Figures 4, 5 and 6 were derived from Fig. 2. Figure 4 is helpful when the distance to the  $\frac{1}{2}$  millivolt contour is desired and the inverse field intensity at one mile is known.

Figure 5 shows the distance to field intensity contours from 100 mv. to 1 mv. for a fixed inverse field intensity at one mile. It shows dis-

tinctly the effect of increased attenuation on the higher frequencies. This disadvantage of the higher frequencies may be partially overcome by the use of more efficient antennas and because of the fact that the noise level is less on the higher frequencies.<sup>9</sup>

All curves are referred to the inverse field strength at one mile. This is the intensity which would be produced if no attenuation were encountered. It is well known that with most installations the field strength at one mile is seldom equal to the theoretical. It may be as low as 60%

of the inverse field in the case of a high frequency on poor soil. The amount of attenuation that may be expected in the first mile with different frequencies is shown by Fig. 6.

Figure 7 is useful for finding the inverse field strength at one mile for different powers and antenna efficiencies. The curves are based on antenna installations having good ground systems and uniform cross section radiators. Lower field strength may be expected if these conditions are not met.

By means of these charts it is pos-

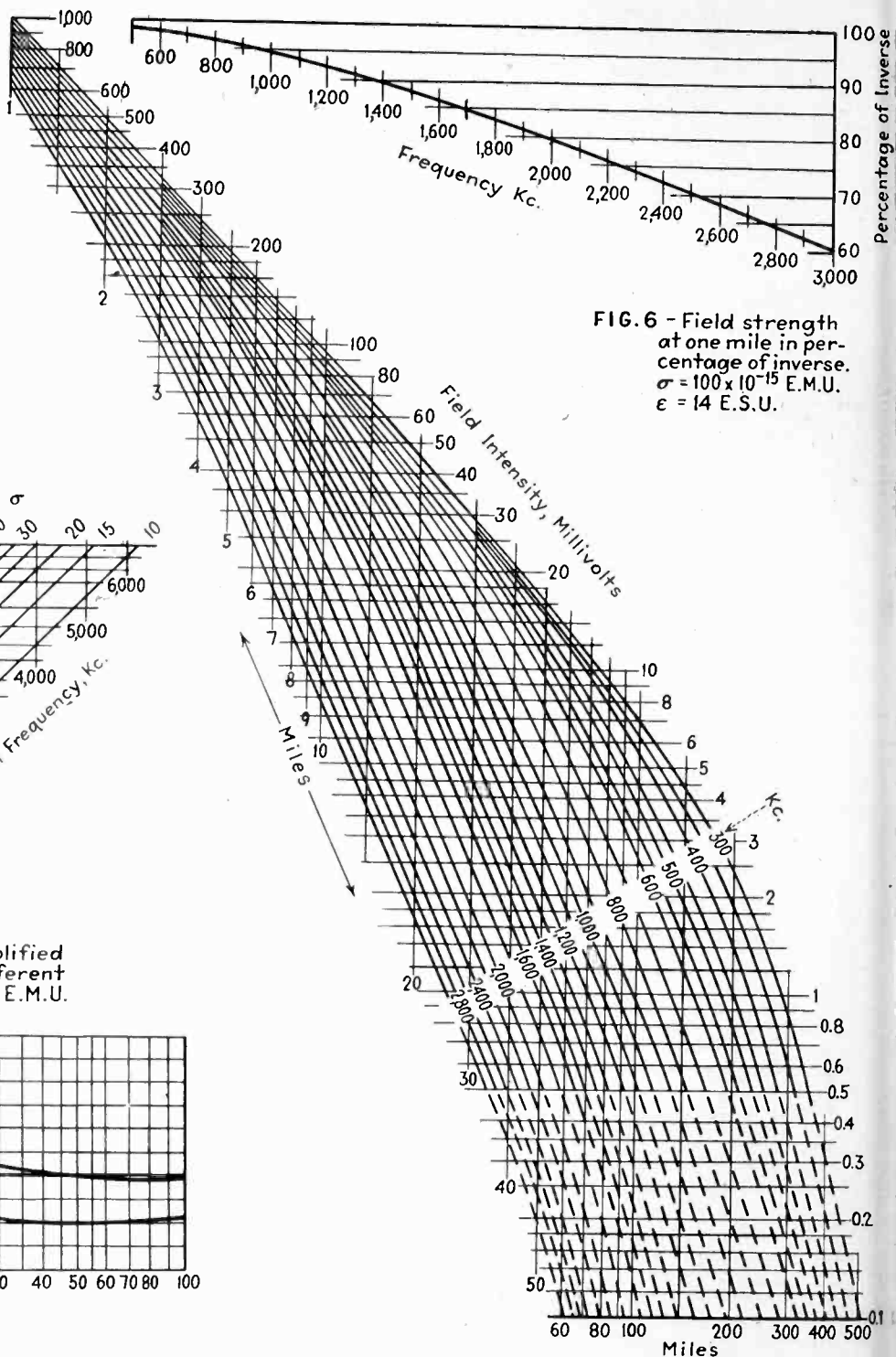

FIG. 6 - Field strength at one mile in percentage of inverse.  $\sigma = 100 \times 10^{-15}$  E.M.U.  $\epsilon = 14$  E.S.U.

FIG. 4 - Distance to  $\frac{1}{2}$  Mv. contour  
 $\sigma = 100 \times 10^{-15}$  E.M.U.  
 $\epsilon = 14$  E.S.U.

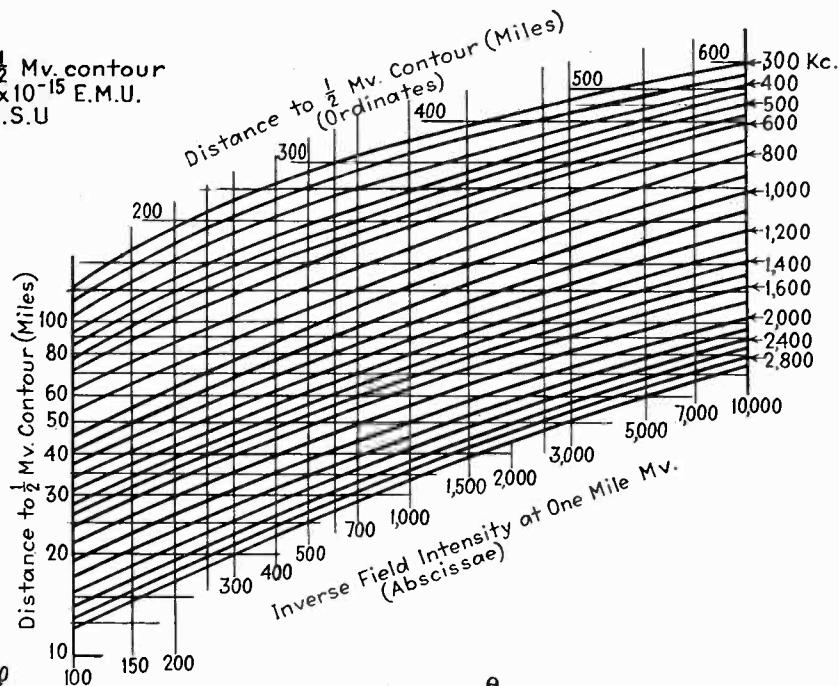
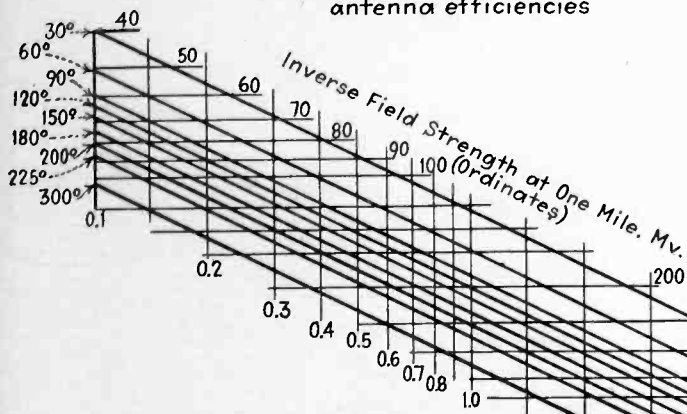

FIG. 7 - Inverse field strength at one mile for different antenna efficiencies



$$h = 2590 \frac{\theta}{f}$$

f = Frequency in Kc.  
 $\theta$  = Electrical height in degrees  
h = Height of radiator in feet

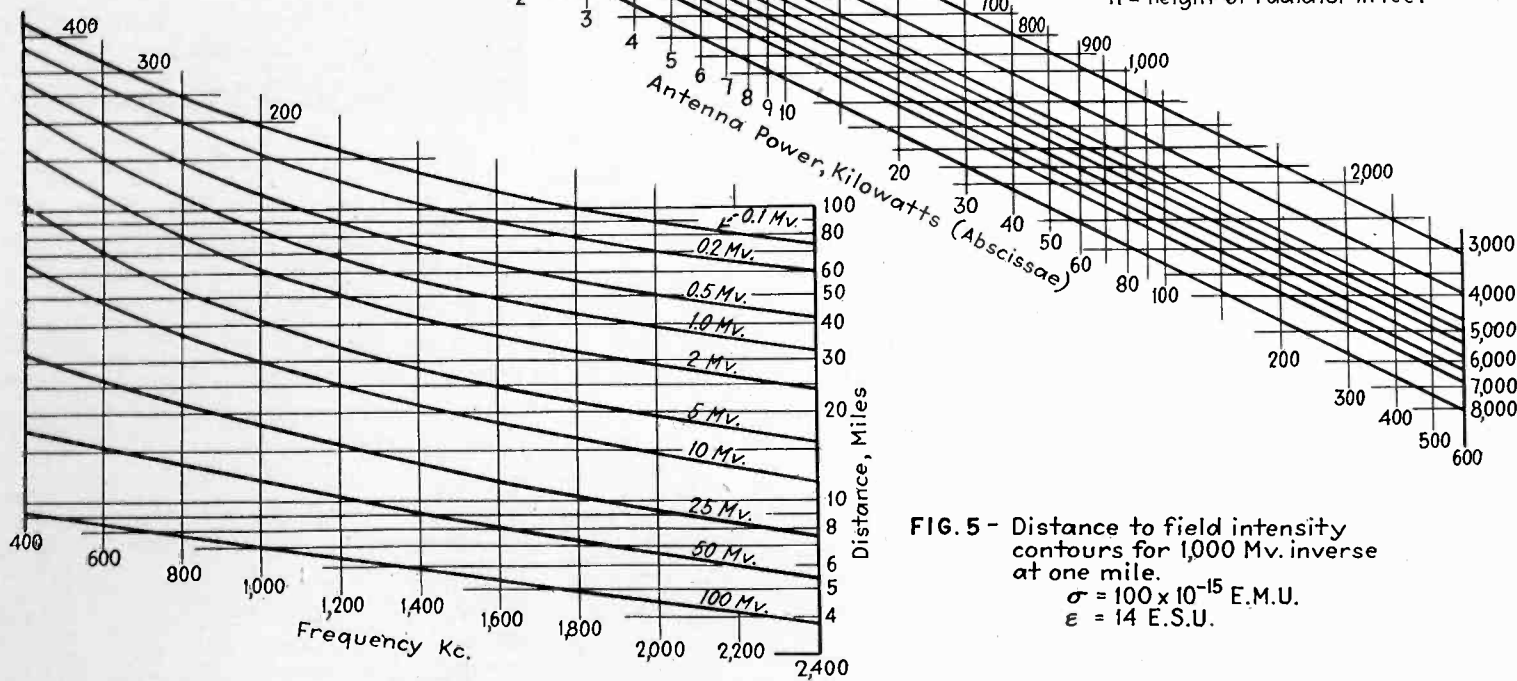

FIG. 5 - Distance to field intensity contours for 1,000 Mv. inverse at one mile.  
 $\sigma = 100 \times 10^{-15}$  E.M.U.  
 $\epsilon = 14$  E.S.U.

sible to rapidly solve almost any propagation problem. A typical problem might be this one: The distance to the  $\frac{1}{2}$  millivolt contour of a station operating on 1000 kc. with 25 kw. power is 72 miles. The antenna is a quarter wave vertical. Find the soil conductivity of the territory served. Using Fig. 7 it is found that the inverse field strength at one mile is 940 millivolts. From Fig. 4 the conversion frequency is found to be 1400 kc. Using Fig. 1 the conductivity from the transmitter to the  $\frac{1}{2}$  millivolt contour is found to be  $50 \times 10^{-15}$  EMU. Other uses for these

charts will readily suggest themselves.

In practice, the Austin-Cohen curves and the Sommerfeld curves have the same faults—that they are applicable only to a fairly uniform terrain and that they fail to take account of natural and artificial irregularities which exert a very marked influence on the propagation of waves. Also, measurements of field intensity made at one point vary from day to day. Some of this variation is caused by changes in conductivity and dielectric constant due to changes in weather. Therefore, it

seems that the simplifications although introducing a slight error, are warranted for practical use.

<sup>1</sup> T. L. Eckersley "Direct Ray Broadcast Transmission" *Proc. I.R.E.* Vol. 20, No. 10, Oct. 1932.

<sup>2</sup> B. Rolf "Numerical discussion of Prof. Sommerfeld's attenuation formula for radio waves." *Ingeniør videnskabelige Akademi* No. 96 (1929) also "Graphs to Prof. Sommerfeld's Attenuation Formula for Radio Waves" *Proc. I.R.E.* Vol. 18, March, 1930.

<sup>3</sup> K. H. Norton "Propagation of Radio Waves over a plane earth." *Nature*, June 8, 1935.

<sup>4</sup> G. N. Watson "The diffraction of electric waves by the earth" *Proc. Roy. Soc. (London) A.* Vol. 95, October, 1918.

<sup>5</sup> Charles R. Burrows "Radio propagation over spherical earth" *Proc. I.R.E.* Vol. 23, No. 5, May, 1935.

<sup>6</sup> G. D. Gillett and M. Eager "Some engineering and economic aspects of radio broadcast coverage" *Proc. I.R.E.* Vol. 24, No. 2, February, 1936.

# An End-of-life Meter

Circuits for measuring the forward drop peak voltages of grid-controlled rectifiers, thereby indicating the approach of end-of-life; or for measuring these voltages under load conditions

By H. W. LORD and O. W. LIVINGSTON

General Electric Company  
Schenectady, N. Y.

**I**N equipment utilizing gaseous discharge tubes it is desirable to have a means of indicating the approach of the end of normal tube life. This is especially true in the case of those installations that require good continuity of service.

The change in forward drop, due to a change in emission, is one indication of the approach of the end of tube life. The drop generally remains practically constant until near the end of life when it increases, slowly at first, and then at an increasing rate. A means of measuring the drop at frequent intervals while the tube is in actual operation, without service interruption, is the most satisfactory method for obtaining the forward-drop measurements.

There are several rather simple methods available for measuring the average and peak forward-drop voltage when Phanotrons (gaseous rectifiers) are used. Phanotrons require only that the measuring circuit have some rectifying means which will permit the forward voltage to register but will not allow the inverse voltage to affect the meter. Figure 1 shows one simple method of measuring average voltage by the use of a small rectifier tube and resistance in series with a d-c microammeter. Readings obtained by such a method must be corrected for the length of the conduction period; that is, two tubes with the same drop but conducting for different numbers of degrees per cycle will not give the same meter indication.

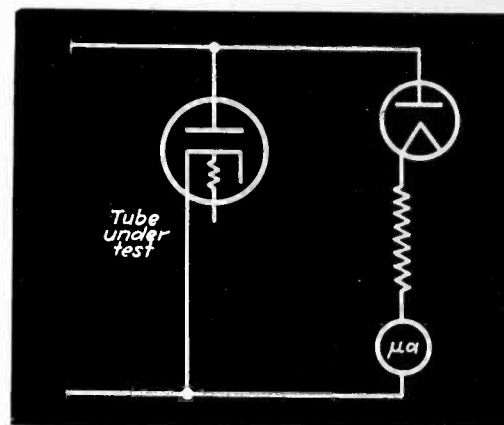

Fig. 1—Simple rectifier test circuit

This effect may be eliminated by using a peak-voltage meter.

### Peak Forward Voltage Meter

Figure 2 shows one type of peak-voltage circuit. With no voltage impressed across resistor  $R_2$  only sufficient current flows through resistor  $R_1$  to bias  $T_1$  (high vacuum amplifier) nearly to cut off, resistor  $R_1$  having a resistance of about one megohm. When a voltage is impressed across  $R_2$  tube  $T_2$  draws current, and charges  $C_1$  to a value that bears an approximately linear relation to the positive peak of the voltage impressed across  $R_2$ , and simultaneously increases the amplifier bias so the grid does not draw current. The linear relation between the positive peak impressed across  $R_2$  and the resulting voltage across  $C_1$  fails to hold when the voltage across  $C_1$  becomes nearly equal to the voltage of battery  $B$ . By making the time constant of the  $C_1, R_1$  circuit long, compared to the frequency of the circuit being measured, the voltage of  $C_1$  does not change appreciably between cycles, and the d-c microammeter in series with  $R_1$  will indicate the voltage across  $C_1$ . The magnitude of the negative peak voltage has no effect on the reading but must be taken into consideration in

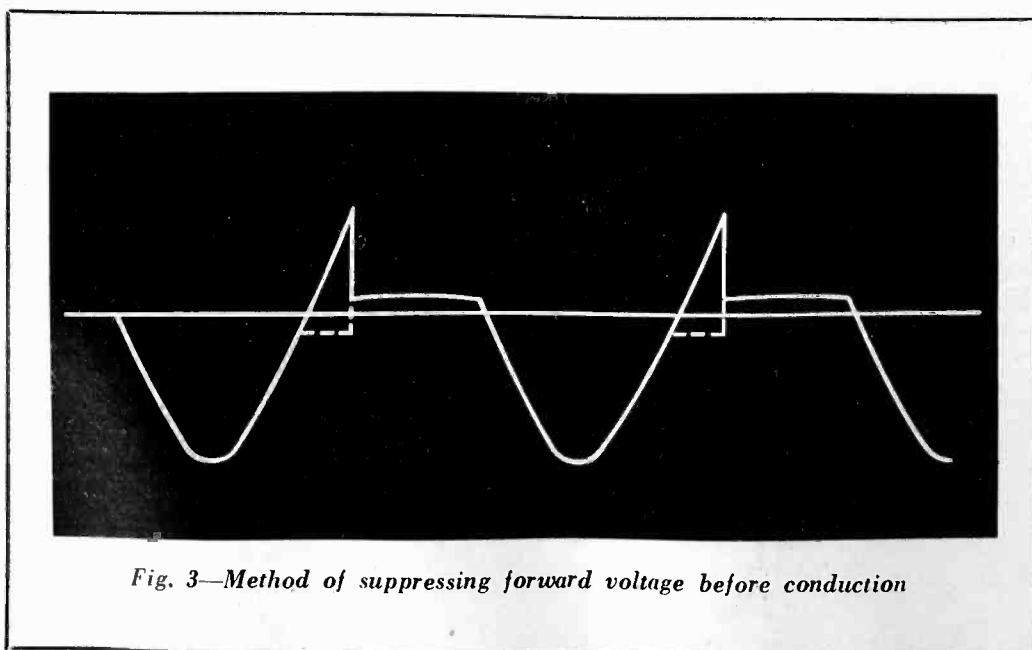

Fig. 3—Method of suppressing forward voltage before conduction

selecting the high-vacuum tube, as the grid must be capable of withstanding the full negative peak voltage.

The above circuit is not suitable for Thyratrons (grid-controlled rectifiers) under most conditions of operation. The peak forward voltage before conduction may be as high as the peak inverse voltage when the grid holds the Thyatron off until late in the positive part of the anode voltage wave. The

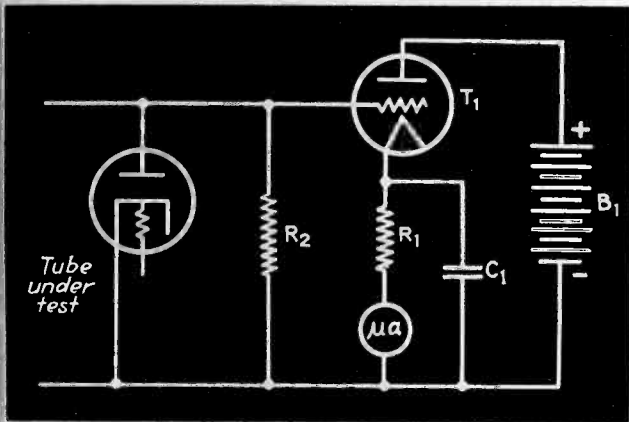

Fig. 2—Peak voltage measuring circuit

peak-voltage measuring circuit for Thyratrons must, therefore, provide a means of removing the forward peak voltage from the voltmeter circuit until conduction occurs. Figure 4 shows a method of accomplishing this.

#### Peak Forward-Drop Meter

The actual peak voltmeter part of the circuit is the same as in Figure 2. The anode-cathode voltage of the tube under test is applied to the peak voltmeter circuit through  $R_2$ . Tube  $T_2$  (a low- $\mu$  high-vacuum tube) in series with a battery  $B_2$ , is shunted across the input to the peak voltmeter circuit. The grid of  $T_2$  is returned to its cathode through the secondary of the current transformer  $CT$ , whose primary is in series with the tube under test. The polarity of  $CT$  is made such that the grid of  $T_2$  is made negative when the tube under test passes current. The glow tube  $GT$  causes the output voltage of  $CT$  to be approximately a square wave. When the grid of  $T_2$  is zero or positive, the impedance of  $T_2$  is low compared to the resistance of  $R_3$ ; consequently the grid of  $T_1$  is held negative by the battery  $B_2$ , even when rather high positive voltages exist on the anode of the tube under test, and the voltmeter circuit

will not indicate these high anode voltages. When the grid of  $T_2$  is made strongly negative by the anode current of the tube under test flowing through the primary of  $CT$ , the impedance of  $T_2$  is very high compared to the resistance of  $R_3$ . The voltmeter circuit will then function normally to indicate the peak forward-drop of the tube under test, since the grid of  $T_1$  does not draw current within the operating range of the voltmeter circuit. Capacitor  $C_2$  is a small capacitor with a high impedance at power frequencies as compared to resistor  $R_3$ , but it prevents high speed transients from affecting the voltmeter circuit.

Figure 3 illustrates the manner of suppressing the forward voltage before conduction. The solid-line curve is the voltage as impressed across resistor  $R_3$ , while the dotted section shows how this curve is modified by  $T_2$  to eliminate the forward voltage before conduction of the tube under test. The curve which includes the dotted section is the shape of the voltage wave impressed on the grid of the voltmeter tube  $T_1$ .

#### Other Applications

The forward-drop voltmeter for Thyratrons has proved to be a valuable tool for uses other than the checking of tubes in permanent installations. A commonly used method of "firing" the immersion ignitor type of mercury pool tubes is to connect the ignitor to the anode

through a Thyatron or rectifier. A positive voltage of about 100 volts impressed on the ignitor is required to "fire" these pool tubes, consequently the forward anode voltage must rise to a voltage slightly in excess of this (due to the drop in the rectifier and current-limiting resistor) before anode current flows. The peak voltmeter, which suppresses this forward voltage before conduction occurs, provides a useful tool for measuring the forward drop voltage of these tubes under load.

EDITOR'S NOTE — Since October, 1932, when H. W. Lord published a paper in *Electronics* entitled "An electronic timer for very short time intervals," several articles have appeared under his signature together with that of his colleagues at the General Electric Vacuum Tube Laboratory. All of them have dealt with phases of the use of electron tubes other than communication. The list of these *Electronics'* articles follows; it provides a brief bibliography of an important element of the electronics art.

"Single tube thyatron inverter", H. W. Lord and O. W. Livingston, April 1933.

"Thyatron control of welding in tube manufacture", H. W. Lord and O. W. Livingston, July 1933.

"Electronic multipliers for high speed counting", H. W. Lord and O. W. Livingston, January 1934.

"Shield grid thyratrons," H. W. Lord and H. T. Maser, April 1934.

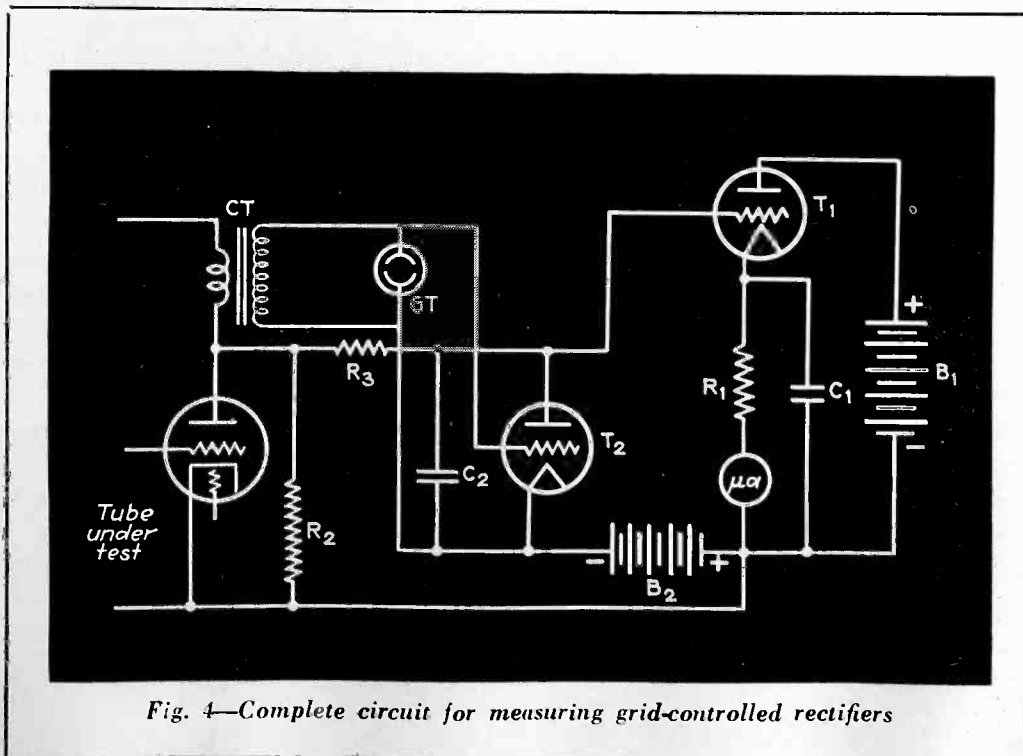

Fig. 4—Complete circuit for measuring grid-controlled rectifiers

# AFC Design Considerations

Automatic control of oscillator frequency as an aid to tuning a modern super-heterodyne is coming into considerable popularity. Mr. White, whose January 1935 paper in *Electronics* started the ball rolling, discusses criteria for design

**N**OW that several makes of receivers with automatic frequency control have appeared on the market, a discussion of AFC design problems might be of interest. A brief paper on one system appeared in *Electronics* for January, 1935, and these remarks are given as the result of continuous intensive development since that time. Briefly, AFC is accomplished by monitoring the intermediate frequency of a superheterodyne receiver by means of a "director" or "discriminator." This unit in turn regulates the operation of a correcting device which changes the oscillator frequency in the proper sense and degree to substantially compensate for inaccuracies in the manual adjustment of the receiver.

The first object of AFC is to produce a receiver incapable of distortion due to mis-tuning. Assuming a receiver with medium high fidelity, capable of reasonably good response out to 5000 cycles with sharp cut-off beyond, let us consider first its action in the broadcast band on a signal of good field strength. As we detune such a receiver, only very slight distortion can be noted until about 3 kc. from resonance. The most noticeable effect is then a loss of the higher frequencies due to the attenuation of one sideband. This loss is most pronounced when the receiver is mistuned about 5 kc. Then a more serious type of distortion predominates, and at about 7 or 8 kc. off resonance becomes highly noticeable. This is due to fairly good reception of one set of sidebands accompanied by partial suppression of the carrier, giving an approximation of single sideband reception, which,

By S. YOUNG WHITE

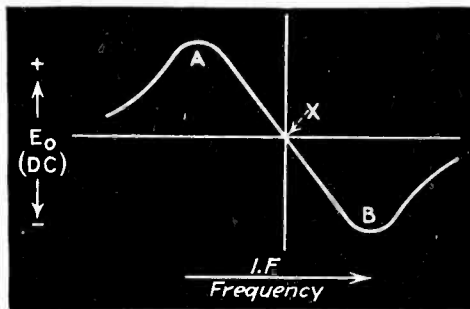
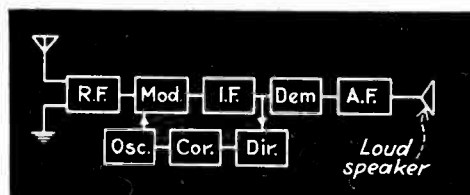

Fig. 1 (above) Block diagram of AFC

Fig. 2 Discriminator curve

unless the carrier be re-introduced, is very distorted indeed. Mistuning of course introduces some distortion due to differentially phasing the sidebands to the carrier, but the major effects have been verified experimentally to be as outlined above.

Since all systems of AFC in practice control the oscillator frequency only, two questions must be answered before the design can be initiated. The questions are (1) how close to exact resonance is the intermediate frequency to be held, and (2) what dial space is a local station to be permitted to cover?

Many tests indicate no noticeable distortion on a medium high fidelity receiver unless it is detuned at least 1.5 kc. In practice frequency correction to within one kilocycle of exact resonance is about the best that can be realized under most conditions. One problem to be met is fre-

quency drift in the i-f amplifier itself, and, of even greater importance, in the discriminator of the AFC system due to age, heat or humidity. Best design to reduce such drift includes using the most stable circuit elements possible and designing all elements with identical coils and capacitors, in order that the i-f amplifier and the discriminator will drift together.

Dial coverage of a given signal can be made as large as desired, but the practical limits are fairly well defined. The pre-selector portion of the receiver is uncontrolled and should, therefore, have a band-pass characteristic with a flat top about 15 kc. wide. Since this cannot often be realized in practice, it is necessary to design around the usual single r-f stage which has considerable selectivity at the low-frequency end of the broadcast band, and much less at the high-frequency end. If the r-f stage is permitted to be seriously mistuned, the peak resonant gain of the r-f stage is lost, with the result that the AVC lessens its control in order to maintain the overall gain of the receiver nearly constant on the channel of the desired signal. However, the r-f peak is now in another channel and its resonant gain on this channel is very high due to the lessened control of the AVC, so that serious cross modulation and "birdies" can occur. This is especially undesirable if the r-f stage happens to align with a channel having serious flutter due to two stations heterodyning on the same channel. In the Chicago district on a winter's night, for example, there may be 25 such fluttering channels, indicating that this risk is far from

remote (or desirable).

Tests in numerous locations during several years have permitted the evolution of a good working rule for the determination of suitable dial coverage. With the AFC rendered inoperative, the receiver is tuned through a signal having good field strength and note made of the dial coverage from where the station is first heard, through the station, to where the station is again inaudible. An attempt is then made to duplicate this dial coverage with the AFC operating to maintain good quality. The station should snap in and out cleanly as close to these boundaries of dial space as possible. There will of course be some hysteresis; all systems inherently snap in close to the station and snap out further away, but this effect may be minimized by careful design.

The discriminator is preferably located at some point at or near the output of the i-f amplifier in order to take full advantage of all the i-f selectivity. It should always be driven by a tube having pronounced limiter characteristics to give a practically uniform output voltage for any antenna input signal voltage exceeding, say, 50 microvolts. Since a limiter tube is a notorious generator of harmonics, the discriminator and its leads should be exposed as little as possible. No type of discriminator should be employed as a source of audio-frequency signal, since the two diode rectifiers are operating under different conditions and react on one another with rather severe distortion. The diodes are advantageously mounted on the discriminator shield can, because the leads to the diodes are part of the tuned circuits and should be as definitely placed as possible. Radiation of harmonics is also better controlled with such an arrangement.

#### *New Problems for the Service Man*

AFC presents serious servicing problems regardless of the type of discriminator employed. Since no serviceman is expected to have a microammeter, alignment of an AFC receiver presents a real problem. One partial solution is to seal the discriminator adjustments and instruct the serviceman to clip an ordinary voltmeter to the cathode of the oscillator control tube. Then after setting his test oscillator to the approximate intermediate frequency of the

receiver and feeding its output to the grid of the modulator tube, he could slowly vary its frequency until he notes a substantial change in the cathode potential of the control tube. This change will follow the S-shaped curve of the discriminator as given in Figure 2 and at the crossover point X will indicate by a reversal of the voltmeter reading that his test oscillator is now at the proper frequency at which to align the i-f amplifier.

Other alignment schemes are believed to require too much of the average serviceman. The overcoupled type of discriminator has the well known difficulty of aligning any overcoupled transformer and still have the crossover frequency exact, and in the type where one circuit is tuned above the intermediate frequency and the other below, the serviceman may reverse them and have a signal-avoiding receiver instead of a signal-seeking one. The permanency of adjustment of a properly designed discriminator can in practice be made good enough to stand repeated shipments and stay well within 100 cycles of its initial adjustment.

The kilocycle separation between the peaks A and B of the discriminator should be small, since this adjustment has an important bearing on the manner in which the AFC drops a station after the dial has been turned beyond it. A separation of 4 kc. should be tried for.

The corrector tube should be designed to give limited control of the oscillator, for instance 7 kc. This should be uniform throughout the broadcast band. Since many high-quality stations are located at the low-frequency end of the band, full correction is desirable at that end. However, if there is more than this same control around 1400 kc., it may be possible to drag out a station over a number of channels, and, in the case of pre-set tuning, this might cause a channel to be slipped. The control tube should be designed to have about  $\pm 5$  kc. control with a change of bias of  $\pm 3$  volts. If the control tube is made more sensitive than this, the frequency of the oscillator will depend too much upon changes in tubes and line voltage as well as upon aging.

[Continued on page 31]



*The author in his Long Island City (N. Y.) laboratory*

# A 6L6 Amplifier

The new beam power tube used in a degenerative amplifier circuit to provide high power output, variable frequency compensation, and low harmonic distortion

**I**N a discussion of high quality reproduction, it is significant to recall experiments conducted a few years back by the Bell Telephone Laboratories involving wire transmission of symphonic music between Philadelphia and Washington in which it was demonstrated that under the proper electrical and acoustical conditions it was possible to achieve a greater degree of emotional excitement and satisfaction through the medium of the loudspeaker than would have been derived from hearing the original performance directly through the air.

In addition to much valuable research on the acoustical side, a great deal of attention was devoted to the necessarily exacting requirements relative to frequency band-width and amplifier capacity essential to so high a degree of tonal fidelity. It was found necessary to transmit without appreciable attenuation the frequencies between 40 and 15,000 cycles to reproduce with their natural qualities the sounds of the various instruments used in music. The frequencies above 12,000 were found important in their contribution to naturalness, spatial effect and brilliance of definition.

Sharing equal importance is the dynamic range or power handling capacity of the amplifier, particularly in the output stage. It has been determined that this range should be ample to accommodate, without overloading of any part, the largest volume swings of a full symphony orchestra up to the highest intensity level which the ear can physically tolerate in the room where the reproduction is to take place. This means, with present-day speaker efficiencies, an electrical output, without noticeable distortion, of at least twenty watts of power for the average large living-room, an output

By **LEON OXMAN**

New York, N. Y.

definitely beyond the capabilities of any pair of receiving-set power tubes in push-pull—until the arrival of the 6L6.

With a pair of the last-named tubes in a simple, self-biased arrangement producing approximately 34 watts of substantially distortion free power as a nucleus, a complete redesign of a laboratory audio system was made incorporating stabilized feedback on the output side, and using a special input amplifier wherein the high and low ends of the frequency spectrum could independently be either raised or depressed at will. This feature is very useful in allowing the depth and brilliance of even the latest high-fidelity recordings to be markedly improved, and also allows the character of needle scratch to be varied to a less objectionable type.

This input amplifier consists of

two stages using metal tubes, the first, a 6J7, having as its plate load the high and low frequency resonating inductances, either of which may be individually tuned to a desired frequency by shunt condensers of different values, selected by a tap switch. A 5000 ohm variable resistor in series with the two coils controls the middle register, while a 50,000 ohm unit shunts each inductance and regulates the height of the resonance curves, acting also as a damping resistor.

The compensating stage is resistance-capacity coupled to a 6C5 triode, which fulfills the two-fold function of amplifier and line coupling tube, feeding into a laboratory-grade plate-to-line transformer, with a specially shielded case having five times the normal magnetic shielding effect of cast iron. A line attenuator interposed between the pre-amplifier, and its following output power-amplifier-unit controls the volume of the entire system.

The variable compensation ampli-

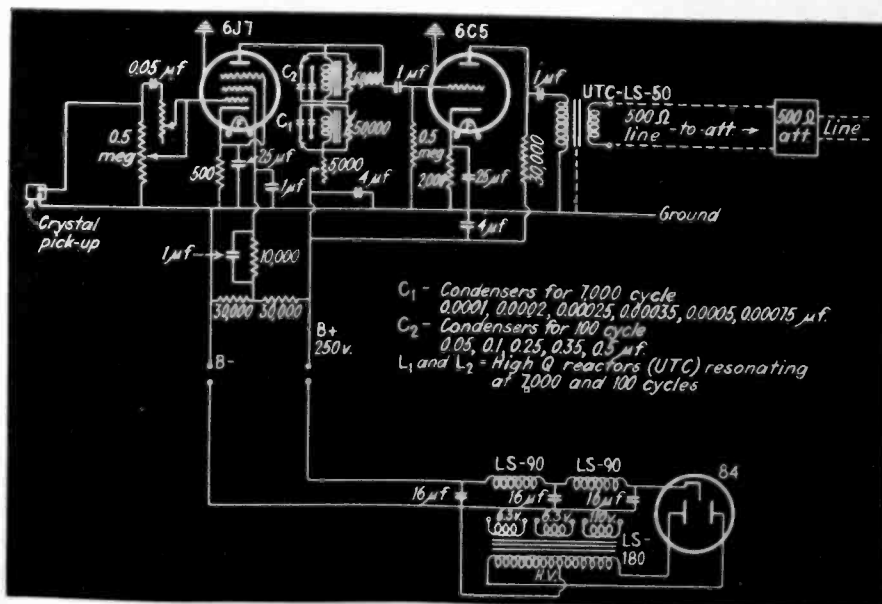

Pickup and preliminary amplifier with power supply



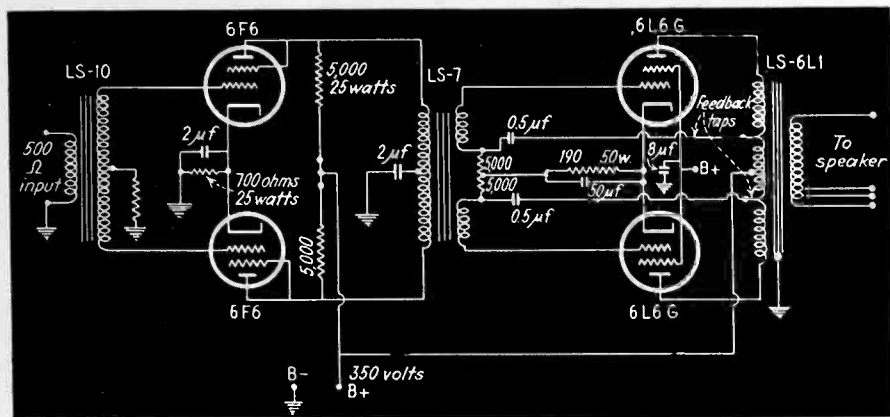

*Degenerative amplifier circuit with driver*

fier, in a glass tube version, and with other minor differences, was developed by Alfred W. Barber for use at high-fidelity station W2XR, and was described by him in *Electronics*, November 1935.

The compensation amplifier built by the writer is housed in an individual dural case, and is powered by a separate supply incorporating an 84 type rectifier. This feature allows the complete separation of the units if, and when, for any reason it is so desired.

The input transformer of the main amplifier is a multiple line-to-two-grams, and feeds a pair of 6F6's, triode connected. These are parallel fed into the interstage transformer which couples them to the 6L6 beam-power tubes. One of the interesting features of this stage is the method of obtaining the feedback voltage. The output transformer has two taps 10 per cent off center on the primary side. Coupling is made from these taps back to the grids of the 6L6's.

This results in a 50 per cent reduction in power sensitivity, but a simultaneous reduction in distortion and modulation products, with a large decrease in effective plate resistance.

The 6L6G tubes of Raytheon were used by the writer in the experimental tests and have glass instead of metal envelopes. Otherwise they are identical with the 6L6's.

It will be observed that 6F6's are used in a position where ordinarily 6C5's are considered satisfactory. However, the 6F6 tubes are run so far below their normal working capacity that the possibility of harmonic distortion from overloading in this stage is practically non-existent. Furthermore, their use provides a comparatively low source impedance for the next stage, a desirable feature from the standpoint of frequency response and stability. And finally, if it is desired to obtain the full 60 watts possible from the 6L6's, the only necessary change is the substitution of a larger output transformer, and the use of fixed bias on the grids.

## AFC Design Considerations

[Continued from page 29]

The high-resistance line from the output of the discriminator to the grid of the oscillator control tube should be designed to have a time constant of the order of 25 milliseconds. If too high a time constant is used the action will be erratic and sluggish, since the charge acquired by the filter capacitor while tuning through a station remains for some time, and is effective on the grid of the control tube, causing mis-tracking of the oscillator with the dial.

AFC is no cure-all for oscillator drift. For example, at the high-frequency end of the broadcast band the user may mistune the receiver nearly to the limit when it is first turned on with the result that, if the drift of the oscillator is in the wrong direction, the station may be dropped as the receiver warms up.

Short-wave performance of an AFC receiver is very striking on first acquaintance. The main point in design is to place a reasonable limit of control on the oscillator frequency.

However, long experience indicates that all systems, depending as they must on the presence of a carrier on which to lock, must fail when the carrier fails. In foreign reception this temporary failure of the carrier is such a usual thing that AFC is subject not only to dropping the station desired, but also perhaps to swinging over and picking up another. This effect is aggravated by user reaction, since dial movement representing a short-wave channel is so slight that the user takes full advantage of the opportunity for careless tuning, and this frequently brings the dial to rest near the signal dropping point.

A properly designed AFC receiver providing a definite dropping of the signal without warning in the form of noticeable distortion gives a shock to the average user because of the sudden transition from a high-quality signal to the noise present on an unoccupied channel. It will be found desirable, therefore, to in-

corporate an inter-channel noise suppression system to give, in combination with AFC, a receiver incapable of producing disagreeable sounds.

The advantages of properly designed AFC can scarcely be over-estimated. There will always be people in every home unable or unwilling to discipline their tuning to take full advantage of at least medium high-fidelity reception. A receiver having a dial coverage from audibility to audibility on a local station of 30 kc. must be tuned to  $\pm 1$  kc., with the result that only about seven per cent of that dial space represents good reception. With proper AFC the range of good reception can be made 100 per cent with sharp cut off at each end, a gain of 16 times. This improvement is greater and more obvious than any improvement in the art in recent years, and is of full advantage in the day-by-day listening to the local stations which constitute 99 per cent of radio listening.

# Views and Reviews

## Principles of Radio Engineering

By R. S. GLASGOW, Associate Professor of Electrical Engineering, Washington University. McGraw-Hill Book Company, New York, 1936. (520 pages, price \$4.00).

THIS WELL-WRITTEN and well-produced volume is the latest of the "Electrical Engineering Texts" the standard series (including such authors as Dawes, Lawrence, Laws, Langsdorf and Chaffee) on which so many of the present generation of electrical engineers were brought up, and it maintains the high standard of its predecessors. In many ways it resembles the books by Terman and Everitt, but it includes considerable information on the newer developments in the field which the older books lack.

The author assumes a knowledge of the fundamentals of electricity and magnetism, and there has been no attempt to avoid mathematical demonstrations, free use being made of calculus and graphical methods throughout the book. In general, an excellent balance between the theoretical and the practical has been found, although the theory of the subject is naturally the basis of the work. This fact does not prevent the author from revealing such interesting information as the normal leakage current per microfarad in wet electrolytic condensers, and similar practical items.

The book opens with a concise statement of the principles of alternating current, proceeds to the properties of resonant circuits (which are completely handled) and reverts to the practical with a chapter on the properties of coils and condensers. Following, chapters on coupled and oscillating circuits lead to a consideration of vacuum tubes and their circuits. Chapter VI, on the fundamentals of vacuum tubes, manages to crowd a great deal of information into 35 pages, while much more extensive treatments of audio and radio frequency amplifiers follow. A single chapter of seven pages on the Input Impedance of a Triode puts worthwhile emphasis on this topic. Oscillators, r-f power amplifiers, modulation theory and practice, and a chapter on detection are included. The newer developments in receiving systems are covered in a separate chapter, and a highly informative section on antennas and wave propagation closes the book. Separate detailed treatment of transmitting systems has been omitted, probably purposefully, but much information on transmitting practice is included in the sections on modulation and r-f power amplifiers.

The author writes with a clear, con-

cise style which inspires much confidence in this reviewer, and it should have the same effect on the student for which the volume is intended. This conciseness, of course, makes a good teacher necessary for the student who is more or less ignorant of the field, but any good text should be written, as this one is, with the instructor's function clearly in mind.

• • •

## Werkstoffkunde Der Hochvakuumtechnik

By W. ESPE and M. KNOLL, (*Materials of High Vacuum Technology*). Published by Julius Springer, Berlin. (383 pages, with 405 figures.) Price bound, 48 German Marks.

THE AUTHORS, both German physicists of note, have undertaken in this work to present a comprehensive treatment of the properties, applications and methods of fabrication of materials suitable for vacuum tube construction. Such highly specialized requirements as ease of degassing, low vapor pressure, rigidity at high temperatures, thermionic work function, thermal emissivity and many others, must be carefully considered in the selection of materials for high vacuum and gaseous discharge tubes. Insofar as possible, this book replaces qualitative and empirical considerations with quantitative data.

In the interest of a systematic presentation, the authors have chosen to devote separate chapters to each of the important materials, treating the properties and processing from the raw material to the finished tube part. Especial attention is given to the applications of each important material. This is a logical arrangement and results in an easily accessible disposition of the subject matter. A considerable portion of the book is devoted to metals and their alloys. There are additional chapters on graphite, glass, mercury, quartz, ceramics, mica, sealing waxes and cements, luminescent materials, gases and vapors, and basing cement. Since tube parts must be capable of withstanding high temperatures during manufacture and operation, special consideration is given to thermal data, crystal structure changes and chemical reactions at high temperatures. These chapters are supplemented with sections dealing with combinations of materials where mutual effects are of importance, such as getters, thermionic, photo and cold cathodes and vacuum-tight seals. Two special chapters comprise the remainder of the book; one is devoted

to essential metallographic principles and the other to the high vacuum technique of metals. The work is profusely illustrated. There are over 400 graphs, diagrams and photographs in addition to 119 tables, many of which present quantitative data. In addition, there is a well arranged bibliography of some 850 references and a complete subject index.

The authors have succeeded admirably in accomplishing their purpose, having produced a well written, thoroughly up-to-date compilation from widely scattered sources, in a field which has been conspicuous by its lack of accessible literature. The book is highly recommended as a valuable asset to vacuum tube engineers and research physicists, as well as a useful reference for other workers in the field of high vacuum technology—H.H.

• • •

## Television with Cathode Rays

By ARTHUR H. HALLORAN. *Pacific Coast Radio Publishing Company, San Francisco. Published in loose-leaf form. (Price \$2.75).*

DESPITE THE CONSIDERABLE amount of information which this volume contains, it cannot be recommended as revealing the full story of cathode ray television. Before any book can lay claim to such completeness, the leading experimenters both in this country and abroad must be willing to release much more information on circuits than is now available. Because of this scarcity of information the author has found it necessary to go somewhat far afield (for example, a good deal of space is taken up with the description of the uses of the cathode ray tube in measurements and in the aligning of radio receivers) but the theory of cathode ray tubes and of their use in television work is clearly expounded. Chapters on electron optics, general radio theory and cathode ray accessory apparatus are included so that the reader is provided with the necessary background. Both Farnsworth and RCA Systems seem to be treated with impartiality, and most of the available information has been included.

The book is a worth-while compilation of information on cathode ray technique in general and it goes as far as is humanly possible in describing television applications. It will be supplemented from time to time with additional data (the book is in loose-leaf form) which may reveal more of the actual details of television practice.

# PATENTS PRACTICE ESSENTIALS

. . . . . A statement of often misunderstood terms used in patent office work, such as the meaning of "invention" and the rights of the inventor, compiled for reference use by inventive engineers



By THAD R. GOLDSBOROUGH

Patent Attorney  
Washington, D. C.

**A**LTHOUGH the subject of patents is a dry one, uninteresting to the majority of us, it is one about which every engineer should be more or less informed. In a short article, such as this, only a few of the high points can be touched, of course, but they may possibly be of future value to the reader who is of an inventive turn of mind.

A patent is a grant, by the Government, of the exclusive right to make, use and sell the patented device, throughout the United States and territories, for a term of seventeen years. The grant is divisible; it covers making, or using, or vending. The owner of the patent may give licenses under each phase of the grant, or he may divest himself, wholly or in part, of the several rights, in favor of separate assignees.

Our modern patent system is based upon a clause in the Constitution reading as follows:

"Congress shall have power to promote the progress of science and useful arts, by securing for limited times to authors and inventors the exclusive right to their respective writings and discoveries."

Many statutes have been enacted by Congress to carry into effect the Constitutional provision, of which Section 4886 is basic. This section reads, in part, as follows:

*"Any person who has invented or discovered any new and useful art, machine, manufacture, or composition of matter, or any new and useful improvements thereof, not known or used by others in this country, before his invention or discovery thereof, and not patented or described in any printed publication in this or any foreign country, before his invention or discovery thereof or more than two years prior to his application, and not in public use or on sale in this country for more than two years prior to his application, unless the same is proved to have been abandoned, may, upon payment of the fees required by law, and other due proceedings had, obtain a patent therefor."*

In the quoted section of the statutes, and in the wording of the patent grant, appear the significant words "invented" and "invention." Around these words centers the major part of our friendly conflict with the Patent Office when we are trying to obtain a patent. Just what is an "invention"? What is the act of inventing?

Fortunately, as will later be pointed out, "inventing" has been given a judicial definition, but "invention" cannot be described in positive terms, though many eminent jurists have tried to do so. At best, we can only say what negatives invention and if any of the negative tests are answered it is presumed that no invention has been made.

## *What Invention is Not?*

**I**N THE FIRST PLACE, it is not invention to produce a process, machine, composition of matter, or design which anyone skilled in the art to which it pertains would produce were the problem placed before him. Again, it is not invention to produce an article which differs from prior articles only in excellence of workmanship.

Further, it is usually not invention to substitute superior for inferior materials, nor is it considered invention to make two devices unitary which heretofore have been separate, and vice versa. It is not invention to so enlarge and strengthen a machine that it will operate on larger materials than before and, in general, it is not invention to lift a machine or a circuit from one art and adapt it to use in another art.

It is not invention to omit or to duplicate a part of a prior machine or circuit unless the omission or duplication gives rise to a new mode of operation; nor is it, in general, invention to substitute equivalents in prior devices which do not change the function of the apparatus or system.

Again, it has been held that no invention is involved in using an old process, machine, manufacture, composition of matter, or design for an analogous purpose. If the purpose is new and non-analogous, however, there may be sufficient basis for a valid patent.

Last, but not least, it is not invention to bring together aggregatively a number of separate ma-

chines or devices each of which operates independently of the others and which contributes only its own function to the complete assemblage. This last mentioned negative test for invention is known as "aggregation" and it is the one which is hardest to convince the average inventor that he escapes.

#### *Tests for Invention*

**A**LL INVENTIONS must be new. That is to say, they must not have been known or used in this country before the alleged invention or discovery, nor patented or described in a printed publication more than two years prior to the date of the patent application nor on public sale more than two years prior to the application day.

There is a further test for invention which is very important, and that is, is the device "useful"? Utility, from the patent standpoint, does not necessarily mean that the invention is such a wonderful advance that it will immediately supplant all others in the field, but at least it must be "useful" in the sense that it is operative for the intended purpose, is not contrary to morals, is not subversive of justice or the like, and is not a gambling device. Some things must be more useful than others, in the patent sense, if a valid patent is to be obtained. For example, it has been held that an adding machine must be 100% perfect while, on the other hand, a simple device like a toy need be useful only in that it affords amusement to the child to whom it is given.

#### *What Good is a Patent?*

**M**ANY ENGINEERS and, in fact, the public in general, are under the impression that a patent gives them permission to make the patented article. Such is not the case, however. A patent confers nothing more or less than the right to prevent others from using the invention defined by the claims and confers no right upon the patentee other than the right to go into Court and sue for infringement. Substantially every patent is dominated by numerous patents which have been issued in the past and which have not yet expired. In other words, assuming that you have a patent on a new radio circuit, this would not permit you to manufacture the device if, for example, the system employed is covered by older patents. You could, however, prevent the owners of those prior patents from using your own patented improvement.

#### *Who Can Get a Patent?*

**A**NYONE, regardless of age or nationality, who first makes an invention which meets the tests of novelty and utility can take out a patent, if the other statutory requirements as to publication, public use, etc. are satisfactorily met. One does not even necessarily have to be

of sound mind in order to take out a patent. It has been stated that a few inventors and most patent attorneys are a wee bit "cracked" but, as you see, that doesn't matter. Even the ladies were permitted to take out patents long prior to the 19th Amendment, and they hold many valuable patents at the present time.

Although the Irishman who just came over here from the old country believed that his compatriot "Pat. Pending" owned all of the new articles which he saw on the market, it is really the aim of the Government to give a patent only to the person who legally is the first inventor. Practically every basic invention has been claimed by more than one person, with the result that many bitterly contested "Interferences" are sometimes necessary before a patent is granted to the inventor who has established his legal priority.

The term "conception of invention" is puzzling to most people. It simply means the mental picture of complete means whereby a certain result may be obtained. Conception is not the realization of a want. It is the realization both of the want and of the specific means whereby the want may be satisfied. In interference proceedings, the date of conception of the invention is best evidenced by the inventor's drawings, his written disclosures, or his discussions with others.

#### *Do Not Hide Your Invention*

**I**T IS, therefore, often advisable to disclose immediately to friends any invention which you may happen to make irrespective of your opinion as to its importance. That is, as soon as you have mentally visualized means whereby a certain desirable result may be obtained, immediately tell some reliable person or persons what you propose to do and, if possible, make a written description of your idea as soon thereafter as convenient. Concealment is a mistake to avoid.

Following conception, the next important step to be taken, is the so-called "reduction to practice." This consists either in filing an application for patent or the making of a full-size operative machine and so testing it that its adaptability and usefulness for its intended purpose are thoroughly established. The making of a model machine or device is usually insufficient. It must be full-size and, if convenient, made of the actual materials which the commercial product will utilize. Records of any actual reduction to practice should be kept in a safe place where they will be available in the event that an interference is declared.

Last, but of paramount importance, every engineer should bear in mind that it is easier to sell a patent or a patent application than an idea, and that every single scrap of paper bearing on his invention should be carefully preserved as evidence.

# Test - TEST - TEST!

**EXAMINE** carefully the IRC products for 1936. Forget they are made by the world's largest manufacturers of resistors. Forget their heritage of engineering experience and outstanding resistor development of past years. Forget their records of dependable service in all types of equipment since 1922.

**TEST** IRC products for the many characteristics required by present day applications. See for yourself the sound engineering behind the design of each of them—the evidences of thoroughness—of thought—of months of laboratory and field tests.

**USE** the IRC Laboratory for special designs—for new requirements—for engineering data.

The Bell Telephone Laboratories have **TESTED** and approved the Metallized filament type resistor for use in Western Electric theatre sound systems and certain other types of amplifiers used in the transmission of sound. In addition, the Metallized unit is approved and used in voice frequency carrier circuits of the Bell Telephone system.

Other types of IRC resistors are used on special radio transmitters and receivers, as well as amplifiers manufactured by the Western Electric Company.



## INTERNATIONAL RESISTANCE CO.

401 NORTH BROAD ST., PHILADELPHIA, PA.

Factories or Licensees in  
CANADA - ENGLAND - FRANCE - GERMANY  
ITALY - DENMARK - AUSTRALIA

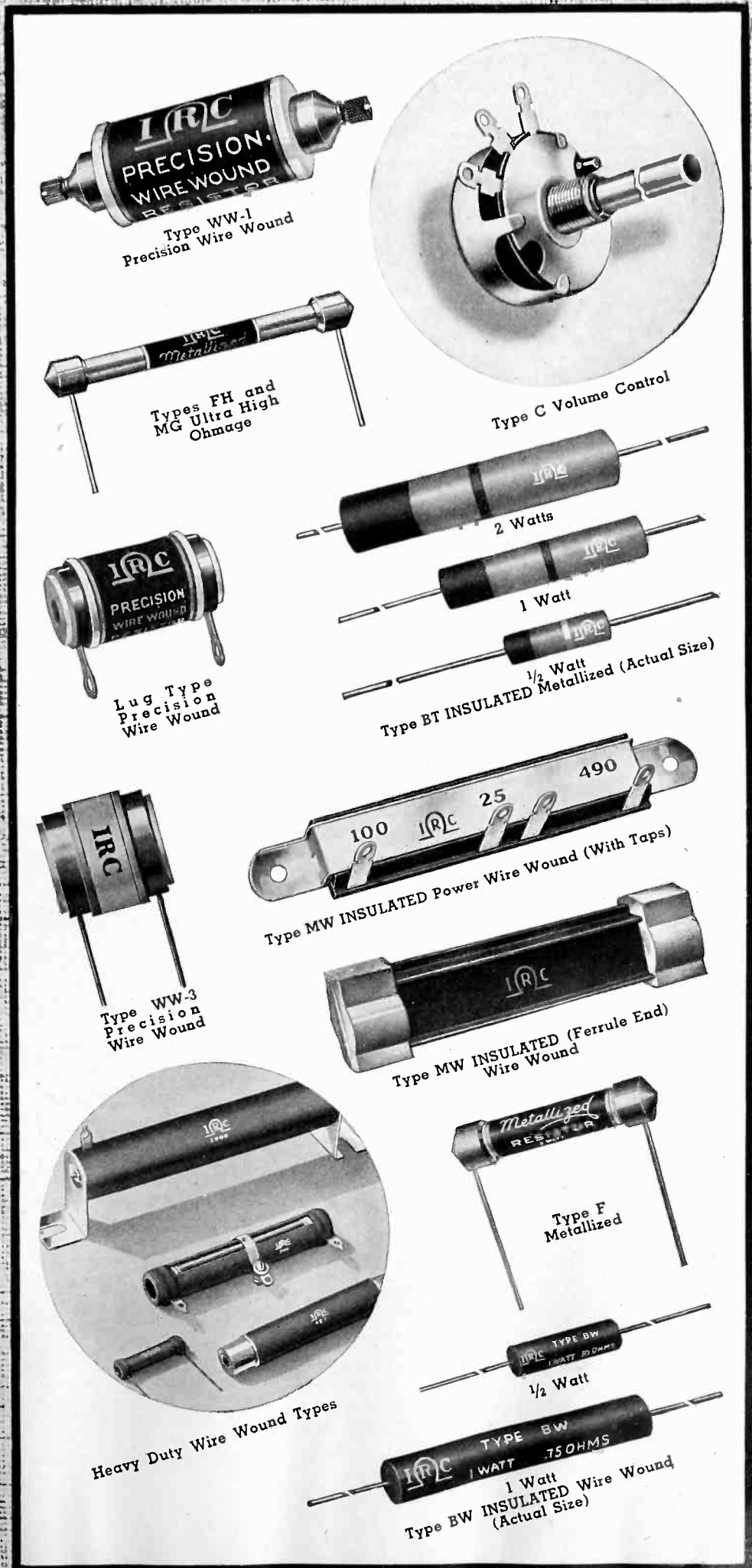

# TUBES AT WORK

**E**LECTRONIC voltage regulating, broadcast equipment economics, commutator roughness measured by tubes, wave-guides, all in the month's new applications.

## Electronic Voltage Regulator For Lamp Testing

By R. R. BRADY and CARL P. BERNHARDT

*Westinghouse Engineering Division,  
New York Office*

IN DETERMINING the proper method of obtaining the actual life of incandescent lamps on test it was decided that in view of the fact that the majority of lamps are burned on alternating current the testing should likewise be on alternating current. It was further decided to test the lamps at their designed voltages, this being known as "normal testing." The first and most essential requirement for testing lamps at normal voltage is to have a constant regulation of the voltage supply. The need for this can be readily seen when the following data are considered:

A lamp which at normal voltage would have a life of 1,000 hours will give only 860 hours if burned one per cent above normal. Also, if this lamp is burned one per cent under normal voltage, it will give approximately 1,160 hours of life. However, in the

latter case the additional life is more than offset by the loss of light output because this drops off considerably more than the corresponding drop in wattage thus giving a very inefficient lamp.

In the past the regulators used for this type of testing were of the vibrating type with a regulation of plus or minus one-quarter per cent or more. The ability, however, to keep the regulation even within wider limits was dependent upon constant supervision and maintenance of mechanical parts and contacts in the regulator. It was, therefore, felt that a different type of regulator, having closer regulation and requiring little supervision, would be a great advantage and the electronic regulator was developed to meet this condition. With this regulator the regulation is held within plus or minus one-tenth of one per cent and as it has no moving parts, all the action being electrical, continual supervision and maintenance is unnecessary.

The power supply is provided by a 250 kv-a, single phase, 60 cycle, 220 volt, 1200 r.p.m. generator driven by a 375 h.p., 2200 volt synchronous motor.

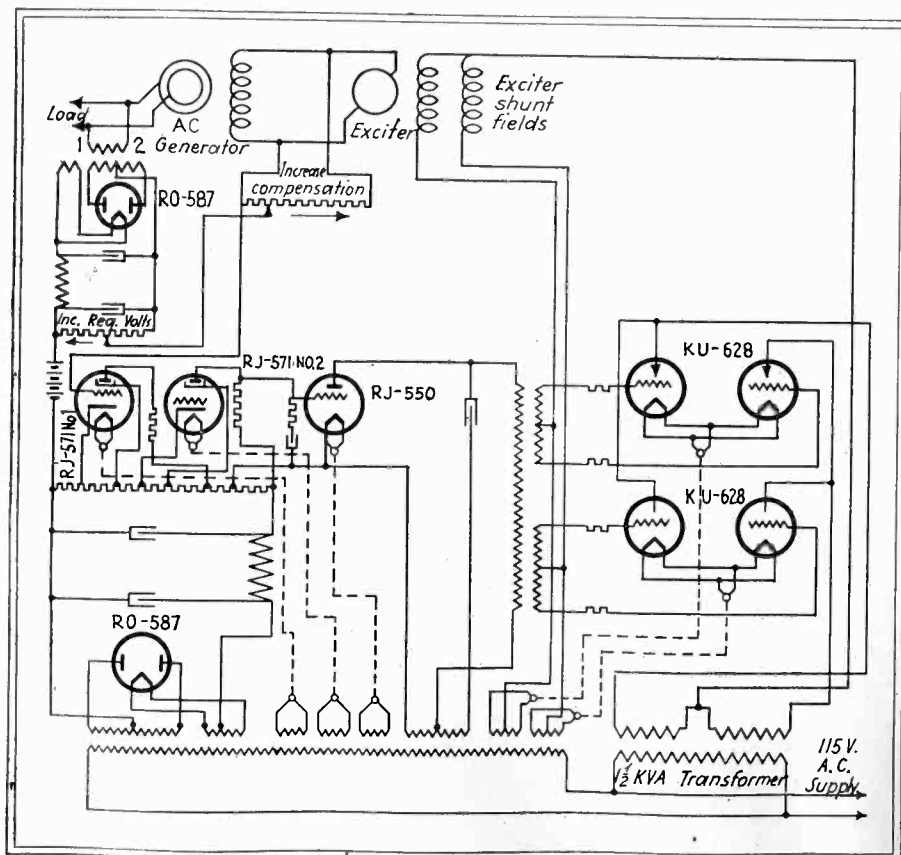

Fig. 1. Diagram of connections of electronic voltage regulator

Separate 6½ kw. 125 volt direct connected exciters were provided for the AC generator and synchronous motor. The regulator controlling the delivered voltage is a type AT electronic voltage regulator, the operating principle of which, referring to Figure No. 1, is as follows:

The generator voltage to be regulated is applied to terminals 1 and 2 and is rectified by the RO-587 full wave rectifier tube, its direct current output being filtered as shown. Two 45 volt "B" batteries are connected to oppose this rectified AC voltage. The resulting difference between these two voltages is amplified by the two RJ-571 amplifier tubes, whose final output is applied to the grid of the RJ-550 tube, which varies the phase relation between the grid voltage and the anode voltage of the four KU-628 grid controlled rectifier tubes. This variation in phase relation causes an increase in the four KU-628 tube anode currents if the generator voltage is decreasing, the anode current providing excitation for the field of the direct connected exciter.

In this scheme of operation the

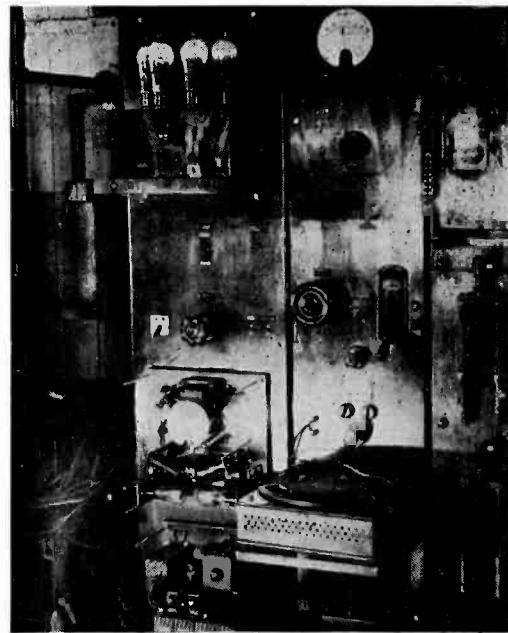

Fig. 2. Generator control panels, showing covers removed from electronic voltage regulator and monitor

KU-628 tube output is actually being used as a pilot exciter, the AC machine excitation being provided by a main exciter. There are four KU-628 grid controlled rectifier tubes provided, the exciter fields being split up into paths each being excited from a pair of two KU-628 tubes connected as a full wave rectifier. Under these conditions a failure of two KU-628 tubes would still permit obtaining proper operation at rated full load of the generator.

This equipment as stated is being used under conditions where it is absolutely necessary to maintain the desired voltage within the limits of plus or minus one-tenth of one per cent, in order to study lamp filament life and the effect on lamp life of proposed

# Announcing

OLD 220B

NEW  
220C

## AN IMPROVED 220 TYPE WATER COOLED AMPLIFIER TUBE

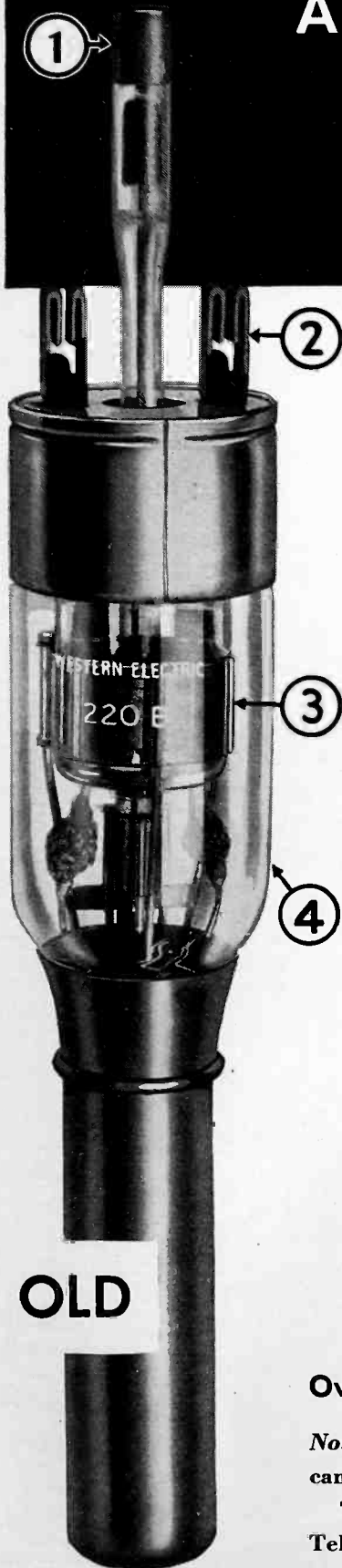

OLD

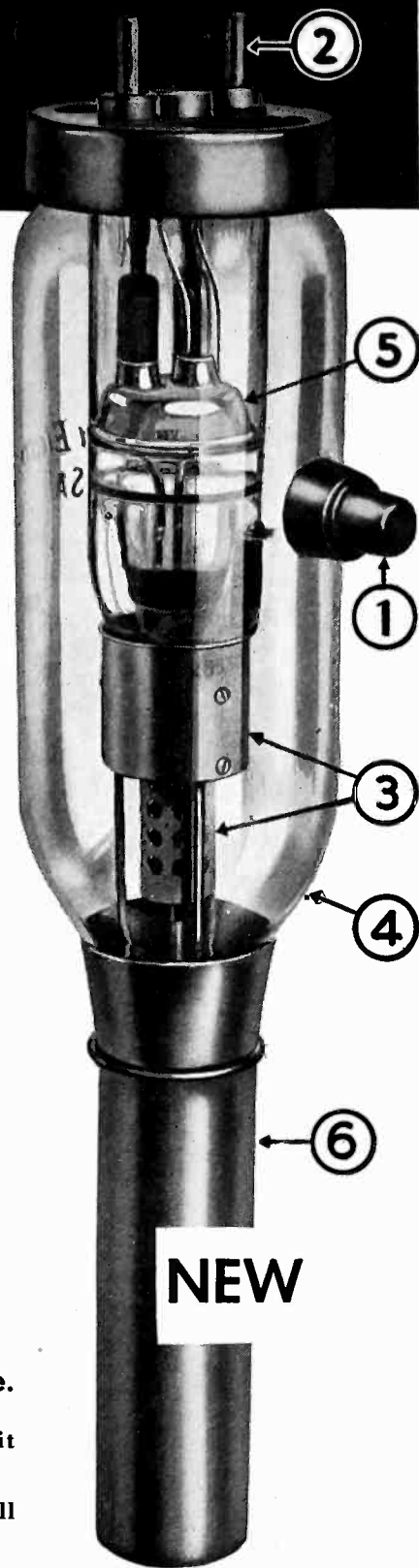

NEW

Modern broadcasting demands improved vacuum tube performance.

The Western Electric 220 water-cooled amplifier tube has been redesigned to meet this demand.

1. Position of grid lead has been changed to improve tube mechanically and to expand frequency range of operation.

2. New base provides for low loss filament connectors and gives increased protection to glassware.

3. Elements mounted on rugged supports with new methods of controlling expansion.

4. Hard Glass.

5. Moulded glass construction with machine assembly assures uniform quality not possible with hand glass-blowing.

6. Improved internal construction.

Overall electrical characteristics remain the same.

Note — Suitable leads are supplied with the 220C Tube so that it can be used in all existing equipments.

This, like all Western Electric Tubes, was designed by Bell Telephone Laboratories.

# Western Electric

Distributed by GRAYBAR Electric Co. In Canada: Northern Electric Co., Ltd.

RADIO TELEPHONE BROADCASTING EQUIPMENT

ELECTRONICS — September 1936

37

# 15 YEARS OF PROGRESS

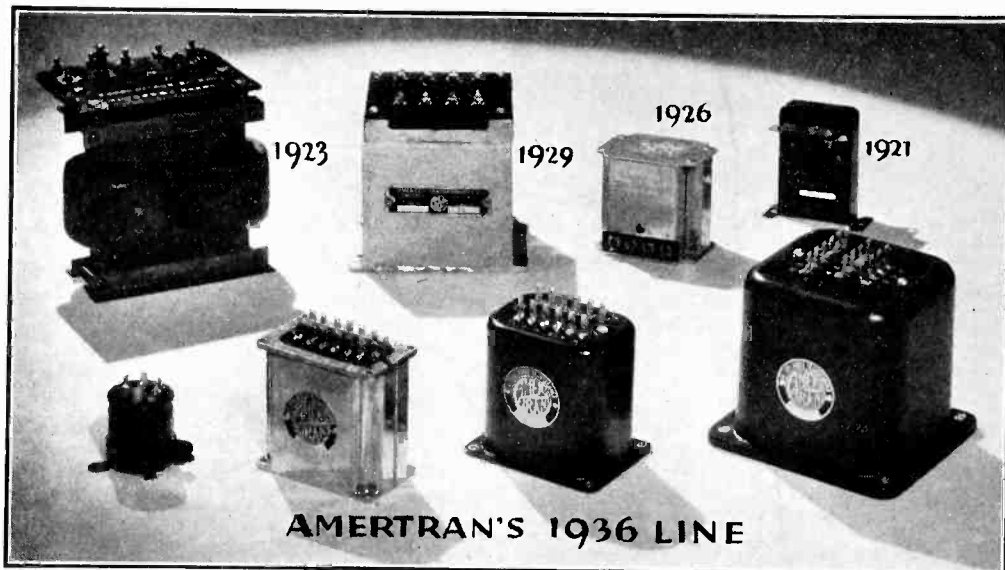

## Improving the Art of SOUND REPRODUCTION

Steadily, for fifteen years, the need for improved sound transmission and reproduction has grown in the fields of entertainment, industry, and education. And for fifteen years AmerTran has supplied the need by improving audio transformer designs. Throughout the world those competent to judge consider AmerTran equipment the "Standard of Excellence."

Results, and results alone, are responsible for the universal acceptance of AmerTran Transformers. Not surpassed by any other manufacturer are audio components incorporating every latest refinement, insertion loss less than 1 dB, and frequency characteristics uniform within  $\pm \frac{1}{2}$  dB from 30 to 16,000 cycles. Such equipment is available for every audio requirement in all sizes of apparatus.

### Improvements in Audio Transformer Design PIONEERED BY AMERTRAN

1920 Quality Audio Transformers. 1923 Self-Shielded Transformers; Electrostatic Shielding; Balanced Coil Structure; Increased flexibility—taps with efficiency unimpaired. 1925 High-Permeability Alloy Core. 1926 High Fidelity; Reversible Mountings. 1929 Moistureproof Construction; Magnetic Shielding. 1933 Symmetrical Designs; Ultra High Fidelity; Extreme Low Level Transformers. 1934 Coordinated Designs; All-Climate Construction. 1935 Miniature Transformers. 1936 Midget Transformers.

May we send Bulletin No. 1002 describing AmerTran's *complete* line of standard transformers for audio-frequency and rectifier circuits?

AMERICAN TRANSFORMER COMPANY, 172 Emmet St., Newark, N. J.



changes in construction. In order to insure that there would be no tendency for the regulated voltage to drift outside of this range an automatic photoelectric type of monitor was installed. This monitor consists essentially of a sensitive indicating meter provided with a small mirror on its moving element. The meter element is arranged so that at normal voltage the mirror does not reflect light on either of two photo cells. Changes in the regulated AC voltages are amplified and impressed upon the moving element of this meter and therefore on a slight change in voltage the mirror on the moving element is deflected, and by the magnification obtained from the lever system of light beams positive operation of either one of the two photo cell controlled relays is obtained. These relays control directly a motor operated voltage adjuster which is connected to recalibrate the AT electronic voltage regulator and thus correct for any possible drift in voltage.

### "High Force Testing"

As the majority of lamps in general use are designed for 1,000 service hours, considerable time elapses between the time of manufacture and the completed test results if the lamps are tested at normal voltage. This means naturally that if for any reason the test results indicate unsatisfactory product, hundreds of thousands of lamps would have been manufactured between the time the lamps were selected and the time the results were obtained.

In view of this it was felt that some method should be devised whereby a constant check could be made quickly of each day's product and, therefore, what is known as "high force testing" was put in use in the factories. With this method of testing the lamps are burned at a considerable over-voltage so that on a 1,000 hour lamp the life results are obtained in approximately five hours, and by the use of factors which have been established through considerable experimental data these actual short life tests on high force testing voltage are converted to the corresponding life at normal voltage. It is, therefore, obvious that where lamps are burning at a 200:1 life ratio it is absolutely essential to maintain the test voltage as closely as possible since a change in the voltage of only one minute duration has the same effect as a change for 200 minutes would have on the normal test basis.

In view of this it was deemed advisable to install a special motor generator set together with an electronic regulator to supply the test voltage for the high force test racks in the factories. Thus with this system in use information is available daily as to the quality of the product being manufactured.

The power supply provided for this purpose is a 50 kv-a single phase, 60 cycle, 220 volt, 1800 r.p.m. generator driven by a 75 h.p. synchronous motor.



# Major Acoustic Benefits from Bakelite Molded

**I**N addition to outstanding electrical, mechanical and chemical merits, the varied characteristics of Bakelite Molded provide major advantages where acoustical considerations are important in product design.

The new Transducer "Bullet" Microphone, pictured, furnishes an interesting example. Its "streamlined" shape is an essential factor in its acoustical design. Bakelite Molded was selected for the forming of this double-shell housing, after several other materials had been rejected.

Three specific characteristics of Bakelite Molded which benefit the acoustics of this microphone are: high accuracy in reproducing difficult designs; satisfactory resonance

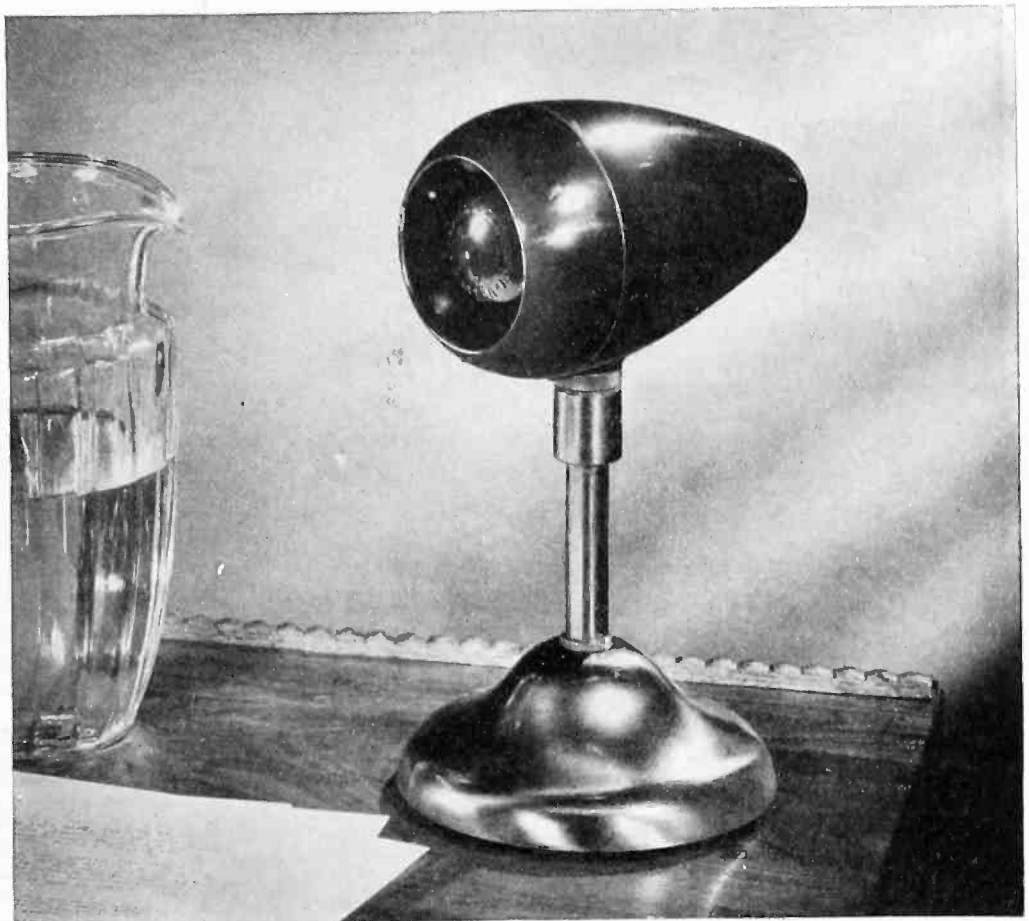

qualities; and freedom from expansion, contraction and distortion due to temperature change or moisture.

The adoption of this material brings other advantages as well. Electrical design is simplified due to the dielectric and insulation values of Bakelite Molded. Also, the double-curved shell can be completed in four press operations, with permanently lustrous surfaces inside and out. Its self-contained finish withstands constant handling, washing and long use, without marring or deterioration.

Electronics engineers are invited to learn the wide range of usefulness of Bakelite Molded in solving difficult design problems. Write for helpful Booklet 13M, "Bakelite Molded," and call on us for further information or assistance.

*(Above) Transducer Microphone, housed in lustrous Bakelite Molded, for public address, sound re-inforcement and recording systems. Product of Transducer Corporation, New York, N. Y. (Left) Four Bakelite Molded parts that quickly assemble into a precision housing for the Transducer "Bullet" Microphone.*

BAKELITE CORPORATION, 247 PARK AVENUE, NEW YORK, N.Y.  
BAKELITE CORPORATION OF CANADA, LIMITED, 163 Dufferin Street, Toronto, Ontario, Canada

## BAKELITE

REGISTERED U. S. PAT. OFF.  
The registered trade marks shown above distinguish materials manufactured by Bakelite Corporation. Under the copied "B" is the numerical sign for infinity, or unlimited quantity. It symbolizes the infinite number of present and future uses of Bakelite Corporation's products.

THE MATERIAL OF A THOUSAND USES

ELECTRONICS — September 1936

39

# MODEL 18-B MICROVOLTER

## 20 TO 100 MEGACYCLES



A NEW instrument, invaluable to the designer and manufacturer of receivers tuning above 20 megacycles.

NEW design brings to the Ultra-High-Frequency region the accuracy, reliability and convenience of operation formerly found only at lower frequencies.

NEW "Transmission Line" output system eliminates lead errors by eliminating the leads. Voltage can be introduced directly into receiver circuits and accurate, reproducible measurements made.

Self-contained coils, direct reading output controls, and power line operation for convenience.

### Specifications:

**FREQUENCY RANGE:** Standard, 20 to 100 megacycles in three coil ranges. Space for a fourth coil is provided. Coils to cover 100 to 150 megacycles, or any range slightly less than 2 to 1 in the 4 to 20 megacycle region, can be provided at an extra cost of \$7.00 each, for use in the fourth position. Coils cannot be supplied for frequencies below 4 or above 150 megacycles.

**OUTPUT CIRCUIT:** Internal impedance 14 ohms, resistive. Voltage appears at end of three foot flexible cable which is part of instrument. Maximum output 100,000 microvolts below 60 mcs., 50,000 microvolts above 60 mcs.

**MODULATION:** 30% at 400 cycles approx. Modulation "ON-OFF" switch provided.

**POWER SUPPLY:** Standard instrument built for operation on 115 volt, 60 cycle power supply. Can be supplied to operate from any reasonable voltage and frequency at additional cost of \$15.00.

**PRICE:** With three standard coils, calibration, standard power unit and complete set of tubes tested in instrument, \$325.00 FOB Newark, N. J. Export packing, including delivery to pier in N. Y., \$2.50 additional.

*For illustrated circular with full details write to*

**FERRIS INSTRUMENT CORPORATION**  
Boonton, N. J.

Separate direct connected exciters are provided for both the generator and motor. The voltage of the generator being controlled by a type AT electronic voltage regulator as shown in Figure No. 2 and as described above. The lamp testing rack is located at a distance of approximately 500 feet from the motor generator set and it was desired, therefore, that the voltage be maintained within the extremely close limits at the load side of the test rack auto transformers. This necessitated, therefore, that the regulator compensate for both varying line drop and transformer regulation under the changing load conditions from no load to full load. Since the control energy required for the operation of the voltage regulator and drawn from the source to be regulated is only 11 volt amperes two pilot wires were run from the regulator to the lamp testing rack, thus eliminating the necessity of providing separate line drop compensators.

### Economics in Broadcast Equipment Design

By V. J. ANDREW

THE STATION ENGINEER and design engineer are continuously confronted with questions of performance versus cost. The only logical solutions to these questions require engineering evaluation of the improved performance, accurate estimate of cost, and comparison with some standard to determine whether the improvement is worth the cost.

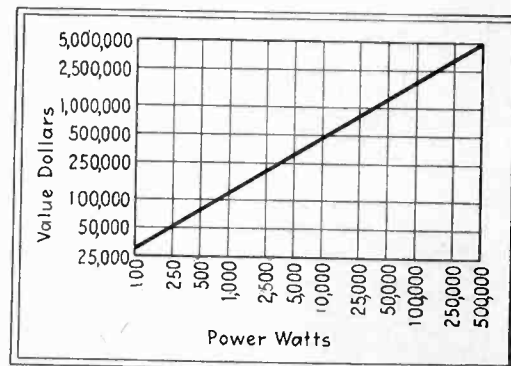
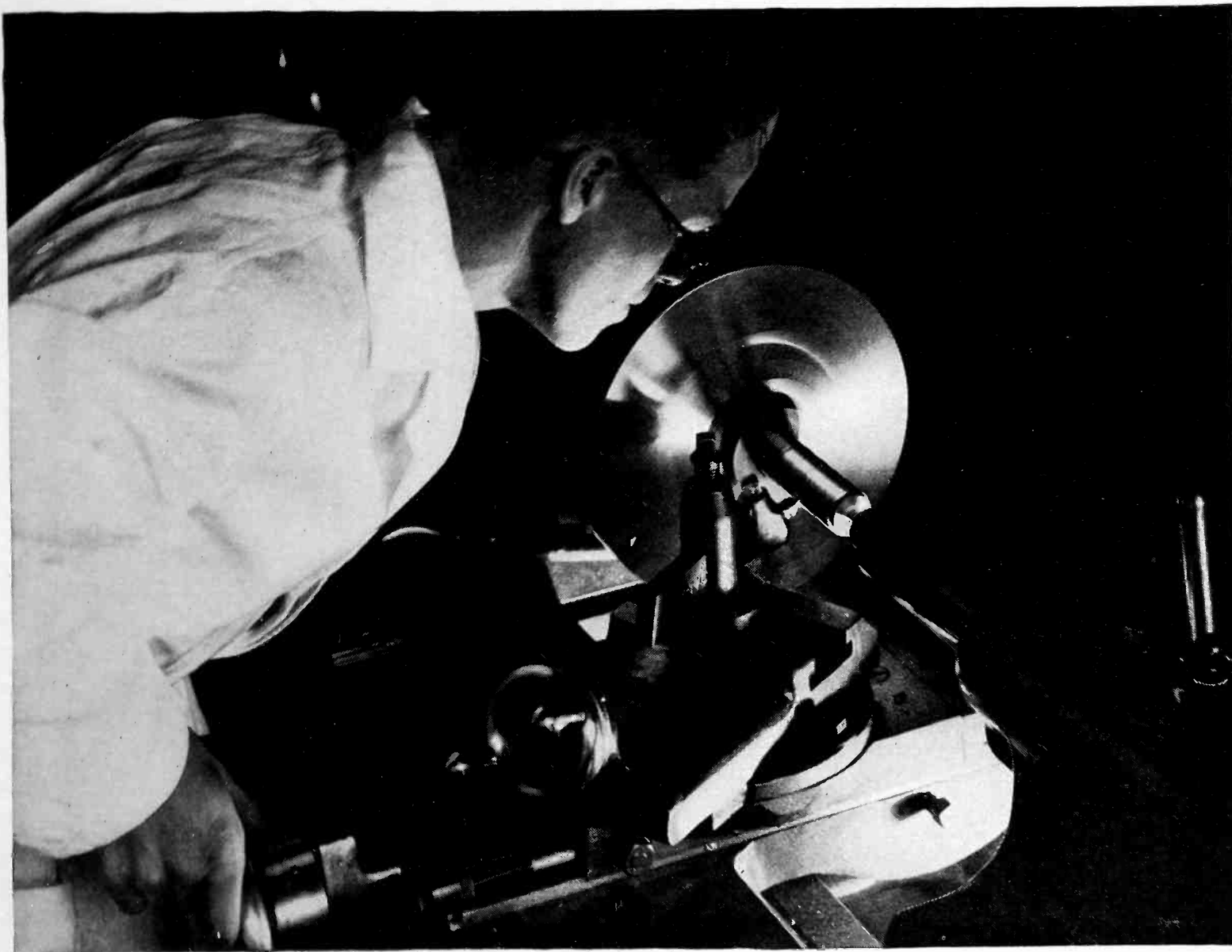

Fig. 1. Equipment vs. cost

Questions such as antenna design which primarily concern signal strength can be evaluated in terms of equivalent increase in power of the station. Figs. 1 and 2 have been worked out as a basis for evaluating improved performance. Fig. 1 is a curve of value of a broadcast station versus power. This curve is based on sales prices or evaluations of stations obtained from various sources. The slope of this curve indicates the rate at which the value of a station increases when the power is increased. This marginal value is plotted in Fig. 2.

Craftsmanship as old as time . . . . .  
in a plant as modern as money can buy



*Turning a lead screw for a Techna recording machine. In the Techna plant, precision is the watchword at every production step.*



In the Techna plant, modern machines and production methods are important in establishing the unusually attractive prices of Techna equipment, but of even more importance to the maintenance of the Techna standard of quality is the

spirit of craftsmanship which directs the men employed here. At Techna, perfection is always the ideal . . . *your* satisfaction the guarantee.

Inquiries regarding specifications and prices of Techna studio speech input, public address, recording, and transcription equipment are given prompt attention.

## TECHNA CORPORATION

NEW YORK

926 HOWARD STREET, SAN FRANCISCO

CHICAGO

Cable address "Techna"

Bell Teletype "SF329"

BROADCAST . . . . PUBLIC ADDRESS . . . . RECORDING . . . . LABORATORY EQUIPMENT



# DUMONT OSCILLOGRAPHS

incorporate many advanced features of design

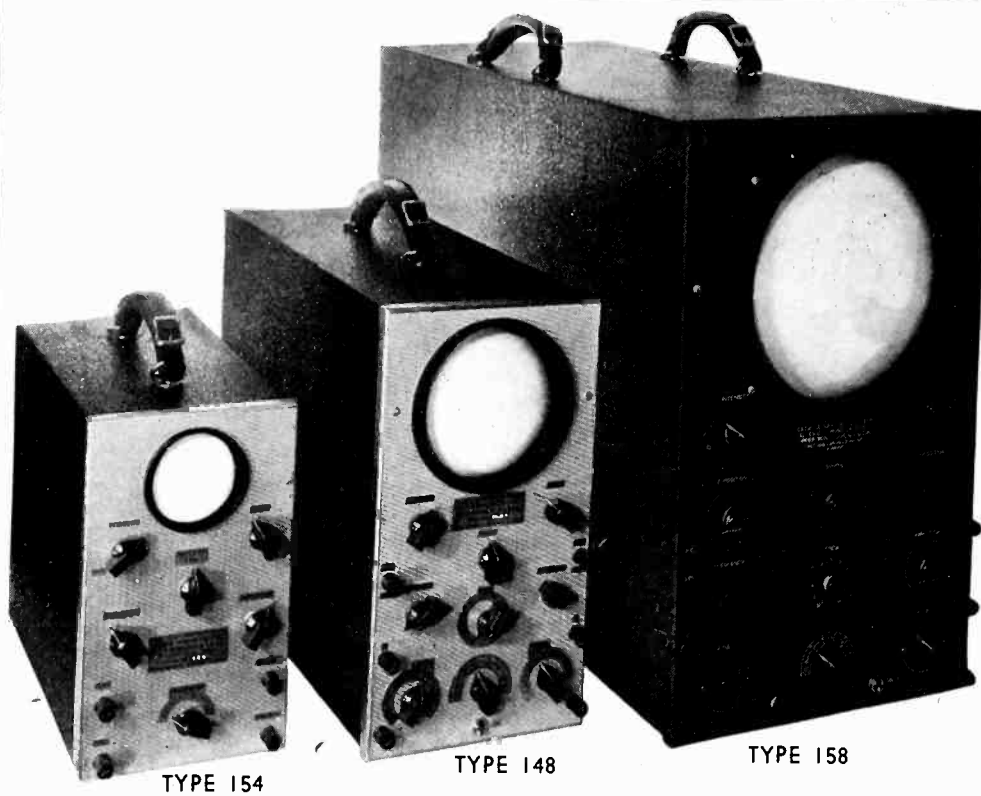

TYPE OSCILLOGRAPH	154	148	158
Recommended Use	Factory Tests Service Work Student Tests Amateur Checking	Factory Tests Laboratories School Demonstration	Factory Tests Laboratories School Demonstration Sales Promotion Special Tests
Cathode Ray Tube Diameter..... Type..... Deflection Plate Leads Screen.....	3 Inches Du Mont 34-XH 2 Common Green	5 Inches Du Mont 54-XH 2 Common Green or Blue	9 Inches Du Mont 94-8-H 4 Separate Green, Blue or Time Delay
Sweep Circuit Range (Fundamental) Discharge Tube..... Synchronization.....	10 to 100,000 cycles Du Mont 885 Internal, External, or 60 cycles	10 to 100,000 cycles Du Mont 128 Internal, External, or 60 cycles	5 to 100,000 cycles Du Mont 128 Internal, External, or 60 cycles
Amplifier Range (10%)..... Gain 1 stage..... 2 stages.....	10 to 100,000 cycles 100 —	10 to 100,000 cycles 25 250	5 to 100,000 cycles 25 250
Anode Voltage.....	1000	1200	Variable 1500* to 3000
Deflection Factor Signal direct to plates Thru 1 stage amp. to plates..... Thru 2 stage amp. to plates.....	75 volts per inch  75 volts per inch	50 volts per inch  2.0 volts per inch  .2 volts per inch	50 volts per inch*  2.0 volts per inch*  .2 volts per inch*
Centering.....	Horizontal and Vertical	Horizontal and Vertical	Horizontal and Vertical
Power Supply Input Voltage..... Watts Consumption.. Cycles.....	110-120 30 50-60	110-120 40 50-60	110-120 80 50-60
Tubes Supplies.....	1 - 34-XH 2 - 57's 1 - 885 2 - 80's	1 - 54-XH 1 - 57 1 - 128 2 - 53's 1 - 80	1 - 94-8-H 1 - 57 1 - 128 2 - 53's 1 - 80 1 - 879
Size Height..... Width..... Length.....	11 inches 6½ inches 13 inches	14 inches 7½ inches 18 inches	20 inches 12 inches 26 inches
Weight.....	18 lbs.	40 lbs.	75 lbs.
Price.....	\$74.50	\$106.50	On Application

Du Mont also manufactures an improved simplified, Electronic Switch and other Oscillograph equipment, including a complete line of cathode ray and sweep discharge tubes. These products are in

the sixth year of successful manufacture. Every Cathode Ray Tube used by Du Mont is engineered and manufactured in the Du Mont Laboratories. Write for detailed information.

**ALLEN B. DUMONT LABS. INC., UPPER MONTCLAIR, N. J.**

Since local factors may alter the value of a station greatly, it is well to reconsider and possibly modify these curves before using them.

To illustrate a cost calculation, consider a 100 watt station planning to install a vertical radiator. The total cost for such an installation is found to be \$2,000 for a height of 0.25 wavelength, \$5,000 for a height of 0.40 wavelength, and \$11,000 for a height of 0.55 wavelength. Increasing from

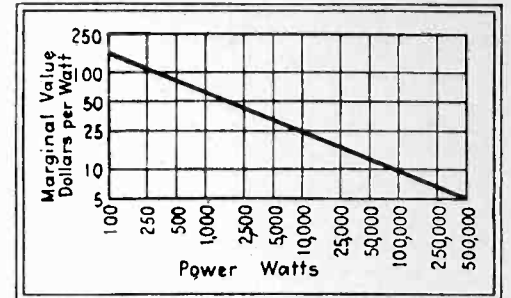
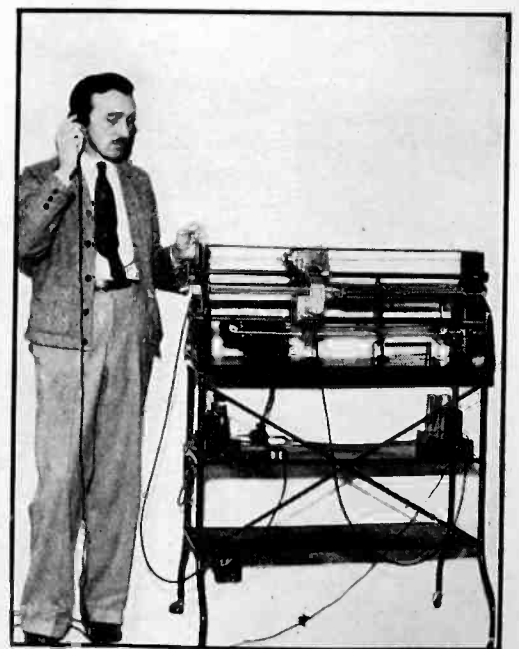

Fig. 2. Marginal cost

0.25 to 0.40 wavelength is expected to increase field strength at one mile from 58 millivolts per meter to 65, equivalent to increasing power 25 watts. The \$3,000 additional cost is a cost of \$120 per watt, which appears from Fig. 2 to be a bargain. But if we consider the 0.55 wavelength antenna, which is expected to give a field strength of 73 millivolts, we find that by comparison with the 0.40 antenna we have gained 26 equivalent watts at a cost of \$230 per watt, which is more than the additional power is worth.

## Phototube "Time-Teller"

This machine announces the correct time for every hour and minute of the



day at three second intervals. Twenty feet of movie film with appropriate sound tracks and a phototube pick-up do the trick, which is expected to be useful for telephonic time-announcing.

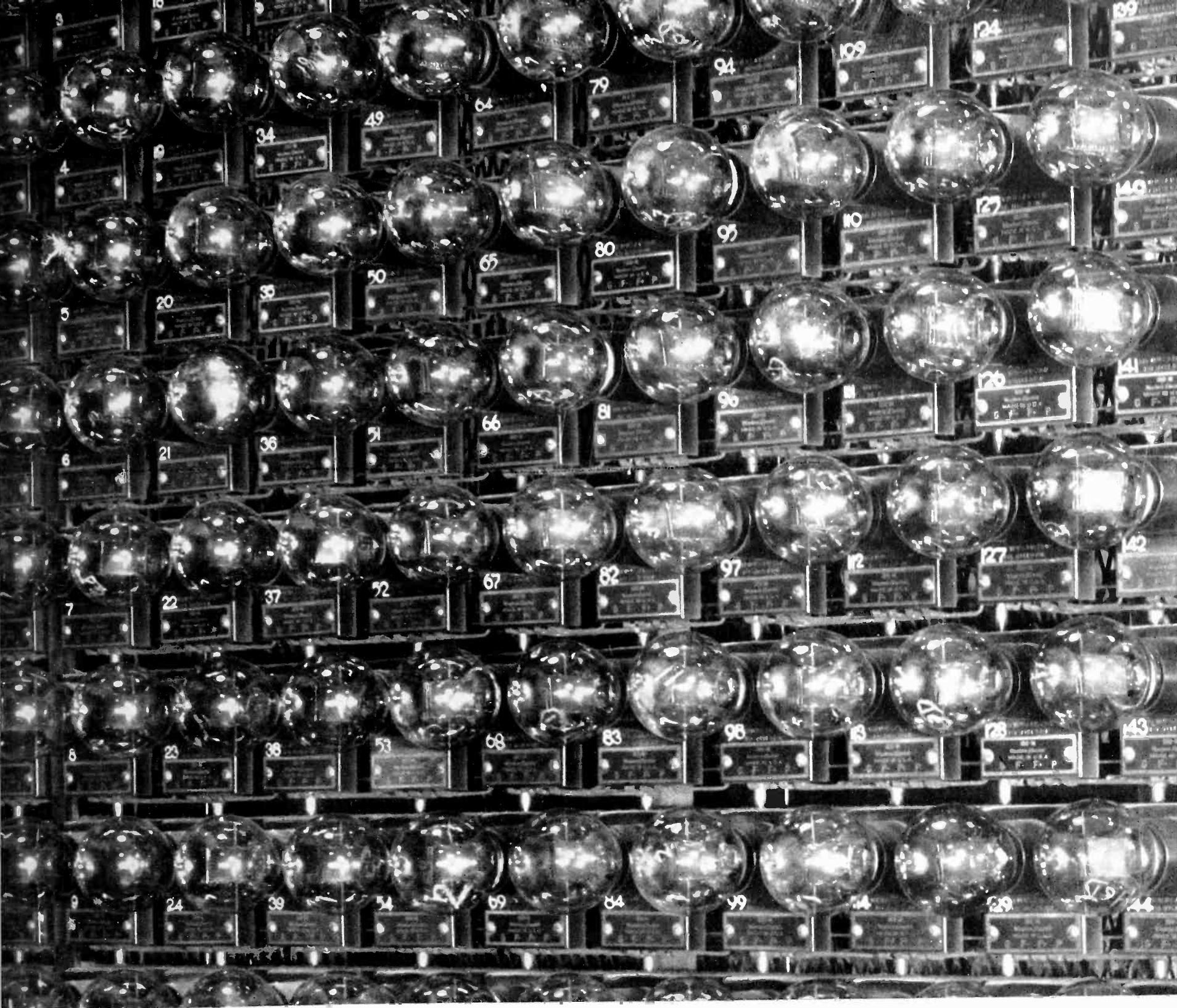

# BELL TELEPHONE LABORATORIES

electronics—september 1936

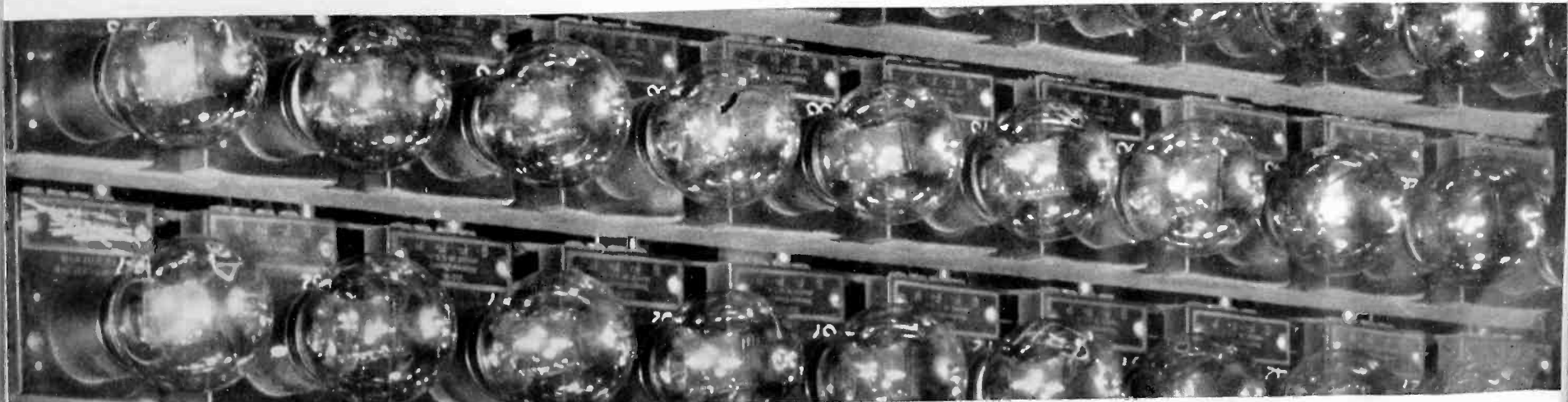

# The story of The Bell Telephone Laboratories

Of the great industrial research organizations of the world, none is more widely known than the Bell Telephone Laboratories. Not only have its men and facilities made it possible to interconnect any of the more than 16 million telephones in the United States with any of the 16 million in other parts of the world, but the communication arts have all gained much by the research carried out in the Laboratories. And science and engineering, generally, have had their share of the fruits borne by this excellent example of planned, industrial research.

The story of the Bell Laboratories—men and machines—should make interesting reading to everyone interested in communication. The *faits accomplis* of the Laboratories are well and favorably known; but the ways in which they are accomplished is at least equally important.

In the following pages, *Electronics* presents a picture of the Bell Telephone Laboratories as seen by its editors, and written from data gathered from their long association with the Laboratories itself, its personnel, its publications, and after a complete tour of its several departments.

**I**N the area bounded by Bethune, West, Washington, and Bank Streets in New York City is a building known over the world among communication men as "463 West Street." This is the headquarters of the Bell Telephone Laboratories, the research and development organization of the Bell System. Here are gathered the greater part of some 1500 highly trained research men and engineers, selected from leading universities and from the system itself, men whose contributions to communication are only a portion of their broad additions to human knowledge, men whose single purpose is to improve telephone communication. The Bell Telephone Laboratories is one of the great examples of organized scientific research, involving, as it does, not only the search for fundamental knowledge, but the synthesis of this knowledge and the adaption of it to the construction of individual pieces of equipment, the assembly of these pieces into systems, and the operation of these systems—all on the basis of an improved technique at a continuously greater economy.

Considered broadly as any form of electrical communication involving the human ear as the final detector and translator of the brain, tele-

phony can legitimately be considered as involving the wire and wireless communication of the human voice, radio broadcasting, and the sound of talking pictures. Telephony, so considered, arose in a laboratory as a result of research; its continued advance as an agency for man's use has continued because of organized scientific research much of which has been carried out at 463 West Street.

When Dr. Bell made his discovery, he was an individual working more or less alone. At that time there was

little organized scientific industrial research. The telegraphic art was fairly well organized, and in the natural growth of the telephone system it followed that this older art was drawn on by the new art for methods and for apparatus. The logical way, however, to increase the income of a telephone system is to extend the length of its lines, to add branches to draw in more customers and to devise ways and means in the central office for effectively switching these lines so that any one subscriber can talk to any other.

This natural extension of the service brought problems. As the lines became longer, attenuation of the already weak electric impulses forced the pioneers to use heavier gage wire, to eliminate the ground return of the telegraphists, and finally to string up copper wire instead of iron conductors. The increasing complexity of inner office switching brought on invention of considerable merit. But nearly all of this development was carried out by individual inventors or by the Western Electric Company which was not then a member of the Bell System.

In thirty-five years, however, much has changed. The telephone system has been called upon for continual expansion of service, and at the same

HISTORY .....	3
PLANT .....	4
ORGANIZATION .....	6
PERSONNEL .....	10
PROJECTS .....	12
BY-PRODUCTS .....	15

time a continual betterment of service. Furthermore, there has been a continuing and successful battle to reduce the costs of this service. Isolated inventors, paralleling each other's work, cannot produce such a history as has developed at the Laboratories, and so it is but natural that such an assembly of technicians as one finds at "463 West Street" should grow up.

The first laboratory of the Telephone Company was in Boston; two others grew up in connection with the manufacturing plant of the system, the Western Electric Company, one in Chicago, one in New York.

In 1907 efficiency and economy dictated that these three groups be combined into a single unit, known as the Engineering Department of the Western Electric Company. This group, the immediate forerunner of the Bell Laboratories, undertook those basic investigations into telephone methods and equipment which could best be carried out under laboratory conditions. From 1907 to 1925 many of the major contributions to telephone technique were developed, and the work of the Engineering Department increased greatly in scope and importance to the system.

By 1925 the work of the Engineering Department had so grown in range and intensity that it was found necessary to set up a separate corporate organization, a member of the Bell System devoted solely to research and development. This Department was accordingly incorporated as the Bell Telephone Laboratories. The corporate organization of the Laboratories indicate definitely the responsibility of the group, which has a dual function. In the first place the Laboratories are responsible to A. T. & T. for the pursuance of fundamental research; in the second place they are responsible to Western Electric (the manufacturing unit of the Bell System) for designs, based on these researches, which are suitable for manufacture. The two-fold purpose of the Laboratories is one of the unique aspects of its organization, and it has resulted both in such beautiful essays into pure research as the electron diffraction discoveries of Davisson and Germer, and to such practical designs as the telephone hand set.

Previous to 1934, A. T. & T. main-

tained certain research and development groups which were not concerned primarily with laboratory work. But in 1934 these were transferred to the Bell Laboratories so that all development and research work for the A. T. & T. is now carried out here.

**T**HE most important facility of any research group (as most research executives proclaim) is money with which to operate, for without proper financial strength men cannot be hired, plant equipment cannot be purchased or installed, the results cannot be published, nor made available for practical use. The financial background of the Laboratories is simple and straightforward. They are owned part and parcel by the A. T. & T. and Western Electric, in joint account. This relationship of the Laboratories to the Bell System is emphasized not only by its board of directors which includes equal representations from the officials of these parent companies, but also by the position of its president, Dr. Frank B. Jewett, who is the vice-president of the A. T. & T. in charge of development and research activities.

The capital stock of the Laboratories, which is non-dividend paying and amounts to \$100,000, its working capital, its operating expenses, and the investment in plant are put up by the two owning companies. Operating expenses, including

salaries, service, supplies, equipment purchases, are lumped together with the item of interest on the loans to the Laboratories by the owning companies. The whole operating expense is budgeted by the Laboratories at the beginning of each year. The budget is approved by its board of directors which contains representations of both A. T. & T. and W. E. who finally, after adjustments are made, pass upon it. Work is performed by the Laboratories for A. T. & T. and W. E. according to this budget and is charged off against it. If some extraordinary item is encountered, which cannot be squeezed inside the budget, an extra appropriation must be made by the company asking for the work; otherwise the work is not done.

In addition the Laboratories carries out some development work for Electrical Research Products (ERPI), a subsidiary of W. E., upon proper financial authorization. Except for this item, which is small, the A. T. & T. and W. E. pay the bill for operating expenses in proportion to the amount of budgeted expense which their respective requirements demand. The total operating expense of the Laboratories for 1935 was well over \$10,000,000.

1886: Bell System laboratory, 141 Pearl Street, Boston

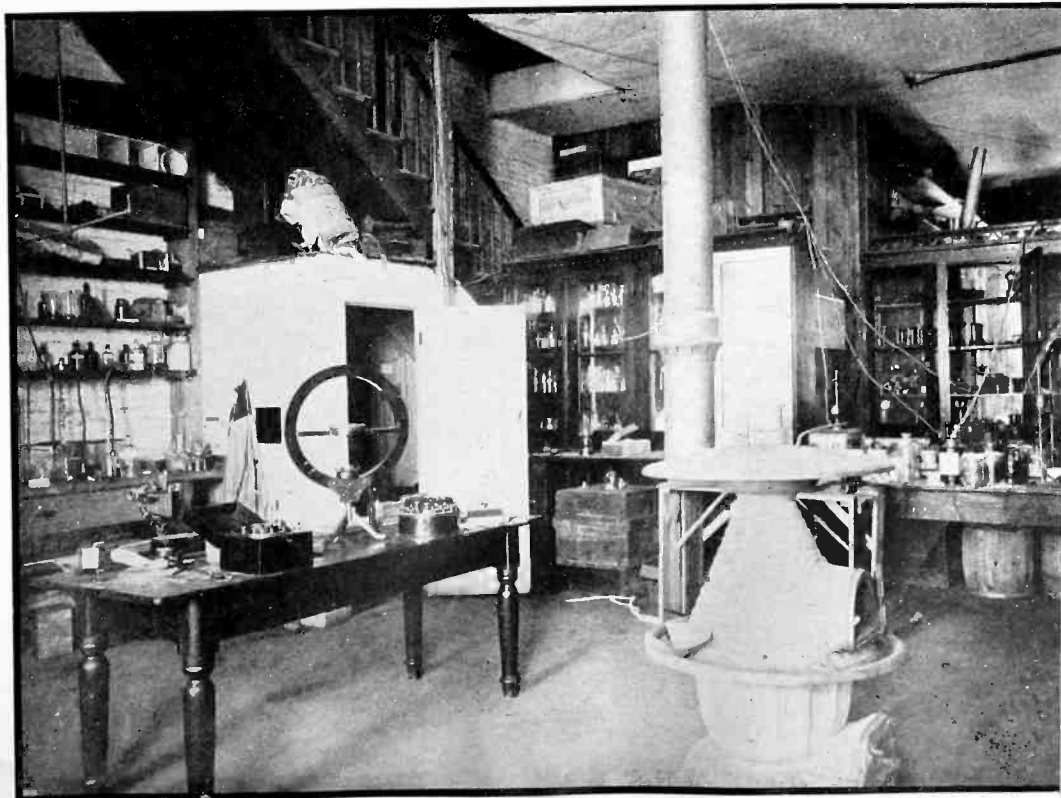

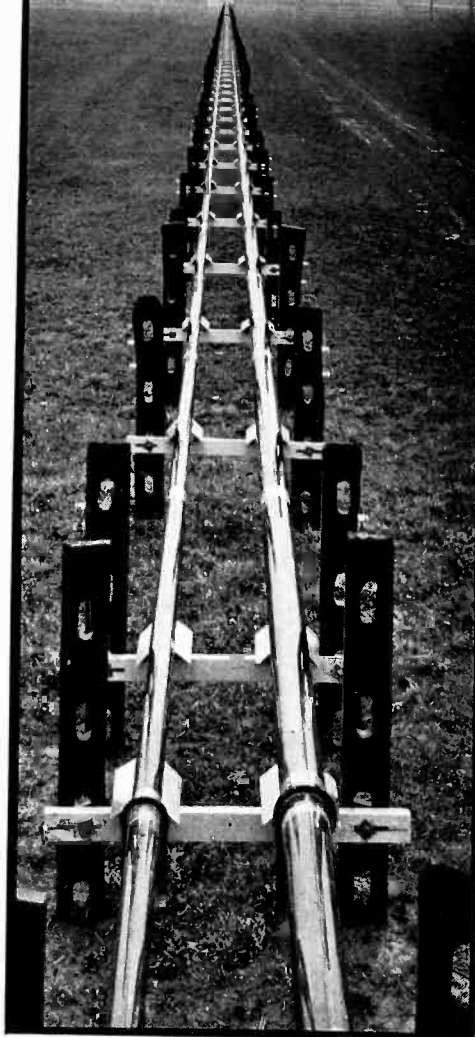
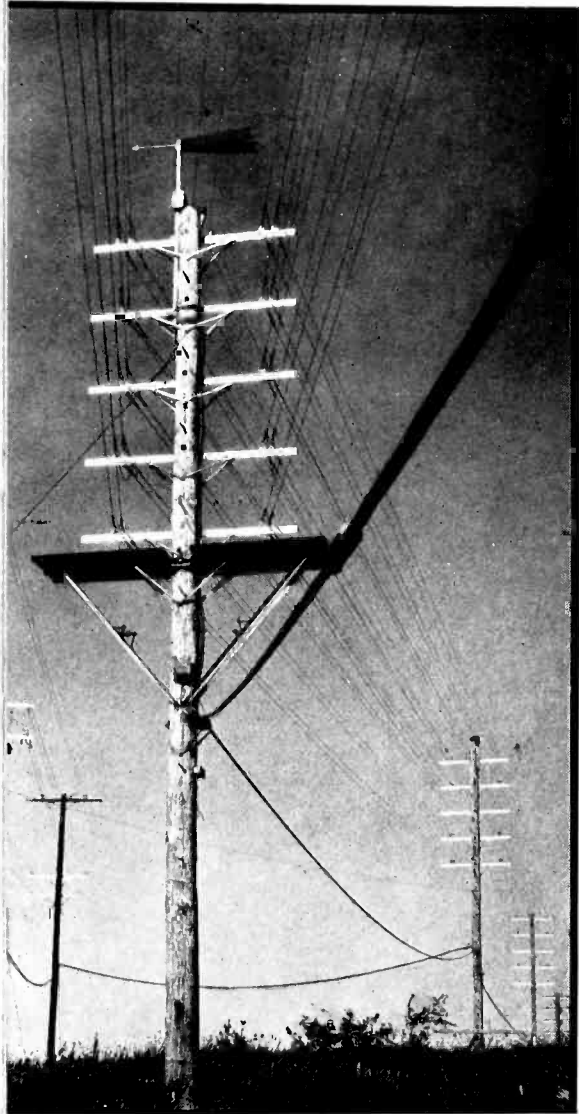

*Holmdel, New Jersey: Experimental wave-guides, four and six inches in diameter, 1250 feet long*

*Chester, New Jersey: Wind tests on open-wire lines*

**A** RESEARCH laboratory is usually housed in a single building or at most a group of buildings close together. Like the telephone system they serve, however, the Laboratories have found it necessary to spread out from buildings to open fields and isolated listening posts, where tests can be made under the wide variety of conditions which telephone and radio equipment must meet. The full schedule of properties owned or leased by the Laboratories or by A. T. & T. or by an associated company includes more than 30 separate locations, from New York to Limon, Colorado, and from Hawthorne, Illinois, to Gulfport, Mississippi.

"463 West Street" is of course the fountainhead. This main laboratory is in fact a group of buildings, wholly owned by the organization (including one small hole through which the trains of New York Cen-

tral make occasional excursions). Here, in nearly 600,000 square feet of floor space are housed over 3000 employees. Executive and administrative offices, services such as purchasing, shipping and receiving, medical, library, transcription and file groups share room with separate laboratory divisions, covering work listed here broadly as chemical, magnetic, acoustic, electronic, filter, materials, microscopic, X-ray, rubber, life testing, sound systems, telephone switching, precision measurement, outside plant, etc.

Across Bethune Street, from the West Street building, is another city block owned by the Laboratories but used now only in part; in a two-story building is a plant where experimental vacuum tubes are made, as preliminary to manufacture by W. E. But the second largest group, in number of employees, is located at 180 Varick Street, about a mile and a half away. Here over five hundred employees are at work on radio development, carrier, repeater, and telegraph systems, telephone trans-

mitters and receivers. Here also is a quartz-crystal shop (whence came the first AT-cut crystal) and laboratories for research in transmission problems.

Over 300 men and women are employed at still another New York building at 250 Hudson Street, where several floors are rented for the Patent Department, for a large group of draftsmen, and for a special group of engineers concerned with foreign-wire relations. In addition there are several small outposts, one at the Western Electric Vacuum Tube shop at 305 Hudson Street, and others at cable factories in Kearny, N. J., Hawthorne, Illinois, and Point Breeze, Maryland, the latter three being concerned with cable research and development. Finally, two small installations at 32 Sixth Avenue and 140 West Street complete the list of "inside locations."

But the story is half-told if only the laboratories with roofs over them are considered. Engineers and research men are found in more than a dozen isolated places in the wide open spaces, whose area is measured in acres rather than in square feet. Most of these "outdoor" plants are located in northern New Jersey, near enough to West Street for frequent contact, but far enough from city noises (both electrical and audible) and other distractions to permit research in radio and other easily-interfered-with services. Outside locations are also essential for testing Outside Plant equipment, such as poles and cable, insulators, loading coils and the like. At Gulfport, Miss., and Limon, Colo., there are plots, each about an acre in extent, where timber products are tested. At Phoenixville, Pa., ten acres are devoted to transmission development.

The group of "outside" laboratories in New Jersey contain altogether about one hundred persons, but the total land involved is well over a thousand acres. The largest is at Holmdel, N. J., the radio receiver laboratory; at Deal is the radio transmitting laboratory. Both of these locations are actively engaged in ultra-high frequency work. At Whippany is a radio transmitting laboratory for high power work, for broadcasting and transoceanic studies, and for airplane transmitters. Two airplanes, used for field tests, are based at Hadley Field.



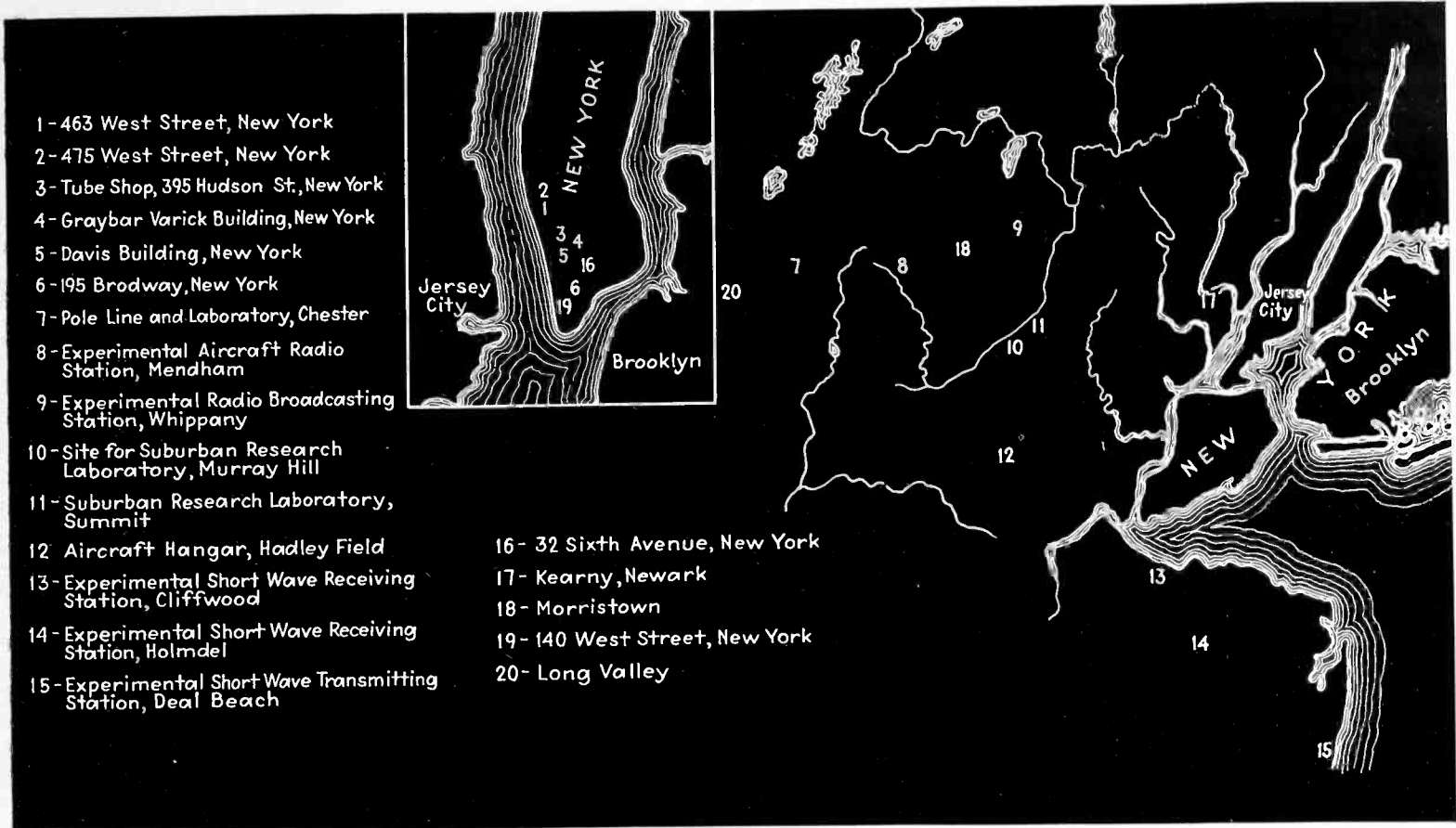

Laboratory locations in and near New York City

At Summit, New Jersey, the Chemistry Department occupies a three-story concrete building with over 8000 feet of floor space. Here a staff of 23 chemists is working on non-rubber insulation, ceramics, dielectric materials, wood preservation, and electrochemical studies on plating, storage batteries and electrolytic condensers.

All of these laboratories, indoors and out, are staffed by permanent groups of from two to thirty men. When special requirements demand other facilities they are rented as the need arises. Occasionally apparatus is set up in unoccupied space in a telephone central office. Certain tests, particularly those on lighting and interference from power lines are carried on by automatic recorders which are left in the care of the local telephone maintenance men, the records being sent to New York from time to time for study and analysis.

Passaic River, New Jersey: Laying the New York-Philadelphia coaxial cable across the Passaic and Hackensack Rivers, June 1936

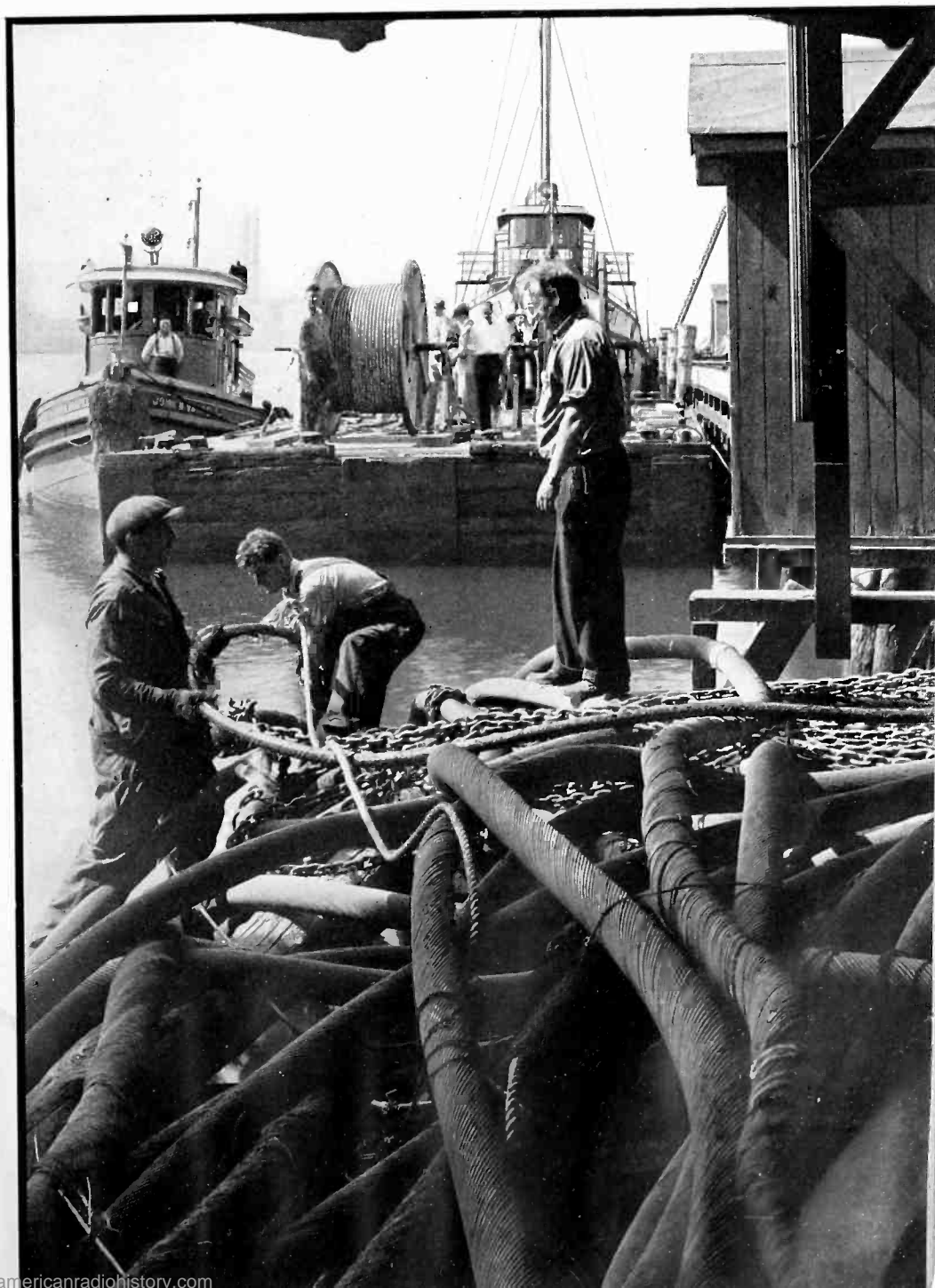

# ORGANIZATION



*Dr. F. B. Jewett, surrounded by some of his early Boston associates, examines a loading coil of the 1904 period. Seated left to right: G. A. Campbell, F. B. Jewett, E. H. Colpitts; Standing, left to right: J. F. Toomey, E. C. Molina, Thomas Shaw, O. B. Blackwell, H. S. Warren, and H. P. Charlesworth*

**I**N the Laboratories there are some 4200 people; of these about 1500 are "members of the technical staff." They have definite creative or supervisory jobs. In addition to the technical staff there must be men who see that the work of the Laboratories is protected by patents, and who see that new designs do not infringe the patents of others. Finally there must be a group of departments made up of those whose responsibility it is to keep the place running.

This latter, "staff," departments resemble those of any well run organization. Its members keep the place in operation, recruit its personnel, keep contact with the outside world, provide heat and light and power and lodging. There are also a Personnel Department and a Bureau of Publication, the latter responsible for the release of technical information to the public and press.

It is the work of the Technical Department that is most interesting to the world at large. Naturally the work of 1500-odd scientists and engineers and mathematicians divides itself into groups. There are five of these: Research Department, Systems Development, Apparatus Development,

Transmission Development, and Protection Development.

The Research group is made up of over 800 employees. Of these 470 are highly trained physicists, chemists, mathematicians, engineers and technicians, some of them known throughout the world for their work.

Probably in no other place in the world is there such an assembly of scientific workers gathered together in an industrial laboratory. The men combine outstanding ability, interest and training in science, with a desire and aptitude for application toward practical ends.

## *Research*

The Research Department uses the tools and methods of physics, chemistry and mathematics. The work is mostly of a fundamental character; it provides basic information on which the engineers of the other departments of the Laboratories build. The Department conducts development work in fields where there is need for unusually close connection between research and development. In particular it develops and designs telephone

transmitters, receivers, vacuum tubes and finishes. This activity represents about a quarter of the effort of the Research Department. The rest is research work, though little of it is like the research in pure science in the universities. It is research with the practical aim of improvement in the methods and devices of electrical communication, conducted with an attitude of inquiry which is satisfied only by determining underlying causes.

Research problems arise through advances made in pure science by members of the staff and by outsiders; through requests and suggestions from within the System; through projects to accomplish the previously impossible; through problems which the Research Department sets for itself.

Through scientific journals, attendance at meetings of professional societies, and through informal contacts, scientists of the Research Department keep in touch with what is being done in their special fields. In addition, one member of the Department is specifically charged with keeping abreast of modern physics and acquainting his colleagues with what he finds.

New projects are important sources of research problems. Typical examples are transcontinental telephony, transatlantic radio telephony, high speed submarine cable telegraphy, stereophonic transmission of music. Most of the inventions used at present for sending several messages over one pair of wires by carrier telephony are the aftermath of the transatlantic radio telephone project of 1915.

Another source of research activity is the task of attaining an ideal to use as a measure and guide for practical performance. Such was the case when, some twenty years ago, the Laboratories set out to establish a sound scientific basis for the design of telephone instruments. The goal was the achievement of as perfect transmission of speech over wire as is experienced when one person speaks directly to another nearby in a quiet room. Only by achieving perfection in the laboratory could the engineers hope to know the possibilities of practical achievement with commercial instruments in the field. It was found that many factors which had previously been neglected affected the behavior of the instru-



*Experimental tube shop; Checking watercooled power tubes*

ments and it was necessary to study the instruments not as detached pieces of machinery but as parts of an acoustical system of which the vocal organs of the speaker and the ear of the listener were also parts. Technical men delved into the mechanism of speech and hearing. So well did they succeed that they became the recognized world authorities in this field. They devised new types of transmitters and receivers, taking no account of manufacturing problems but concerning themselves only with perfection of operation. When the goal of perfect transmission was finally attained the Laboratories was in a position to measure quantitatively how far short of perfection their commercial instruments fell and to take steps to improve them.

There is another type of work in which the Research men delight. This is to dig into some phenomenon that is not well understood, to get the exact reason for its existence, and on the way, perhaps to discover other (economic) facts. For example—

Emile Berliner, one of the early workers on the carbon microphone claimed that current jumped across the space between the grains. This was a possibility, but seemed unlikely. Others thought there was an electric arc; still others felt that some deformation of the grains made it possible for the microphone to pass more current when it was spoken into. There was another theory that the absorbed air had something to do with the varying conductivity.

The Bell engineers turned their tools loose on this problem—what was the phenomenon underlying the action of the carbon microphone, already in existence and practical use for a long time? In their endeavor to find out exactly why the microphone worked, they discovered why carbon microphones age and go bad in service. Now they think they have found a way to get rid of this aging factor, long an important item among the problems of engineering transmitters. It is too early to estimate the resulting gain in economy or improved service, but this research will in the course of time justify all that it has cost.

In an industrial laboratory, the essential criterion for the prosecution of research is: what will it produce economically? Thus one might wonder about the economic value of the work of Davisson and Germer on fundamental electronics which led to the proof that electrons have both particle and wave motion characteristics.

But it must be remembered that there are 250,000 electron tubes used in the Bell System, that each one draws filament current and power—largely from storage batteries—and that any increase in emission efficiency of tube cathodes would result immediately in a considerable saving

*Research: Measuring a unit quantity of carbon granules*

in the annual power bill. Here then is sufficient justification for research of this fundamental type.

The principal products of the Research Department are new facts, new relationships and new ideas. The output of facts and relations is rapidly disseminated among those in the development departments who can make use of the results.

From the Research Department have come such fundamental research products as the permalloys and perminvars; new insulating materials (paragutta is a good example), much of our present knowledge of the properties of speech, noise, music and of the auditory characteristics of the ear. The early history of the high-vacuum electron tubes is closely related to the activities of the Research Department; from this work have come many members of the electron tube family. For years the cathode ray tube—now becoming so important in all manner of research—was obtainable only from the Western Electric Company. New forms of transmitters and receivers and microphones came from the Laboratories; so did the light valve, the quartz-crystal filter, and much of our knowledge of photoelectricity.

#### *Apparatus Development*

Several groups work under the general head of the Apparatus Development Departments. In general



# BELL TELEPHONE LABORATORIES

## Staff and Service Departments

Patents

Research

Engineering

Protection

Apparatus

Systems

## Transmission

these departments are responsible for the development and design of apparatus for wire and wireless communication. They study to reduce costs, either in manufacture, maintenance, and repair or through improved service. Investigation of materials entering into the entire Bell System is made here; and specifications for the purchase and manufacture of standards fall to the lot of this group.

The personnel of the Apparatus Development departments is divided for our purposes into three groups:

First, those who design the equipment and tools for use by the "outside plant" of the Bell System. This group works closely with Western Electric. It is responsible for the development of cables. Everything used in the field from bare wire to poles undergoes continuous scrutiny by the personnel of this group. This group functions largely in the several outside locations. It designs new or improved methods of construction and develops the necessary tools.

From a second group come apparatus strictly useful to the telephone art, such as transformers, relays, condensers, filters, networks, cords, lamps, keys, plugs, jacks, and protective devices. Transmission measuring apparatus, loading or retard coils originate here. Components entering into dial telephone switchboards, teletypewriter apparatus, equipment for recording and reproducing sound by mechanical processes, contacts used in switching mechanisms see light of day here. Other members of this group are experts on metallic and insulating materials.

A third group is known as the Inspection Engineering Department.

The name is descriptive. Here are developed methods of inspection and their adaptation to use by manufacturer and installer. Standards of quality for communication apparatus and systems; analysis of inspection data; never-ending studies of the service performance of laboratory designs are part of the work performed by men in this important group. For the latter responsibility, the department has in the field a corps of engineers who maintain contacts with the engineering and plant departments of the Bell Telephone companies and advise their colleagues in the design departments of their findings.

The final division of the Apparatus Development Department may be called, for our purpose (they are not called such in the Bell System) the By-Product group. Although the primary function of the Laboratories is to improve telephone communication, the same principles are involved in broadcasting speech by radio, and in impressing the human voice, or music, on records of various media—such as film or disc or iron wire—and in translating these electrical or mechanical recordings back into sound. It is inevitable therefore that certain studies or apparatus or materials or systems of components should be useful to radio telephony, to broadcasting, to sound motion pictures. Air transport companies and itinerant fliers rely upon Western Electric transmitting and receiving radio apparatus for much of their communication between ground and plane. Many a metropolitan or state police radio station and car has in it apparatus developed in this By-Product group. Many of the best known broadcasting stations were engineered by members of the

Bell Laboratories staff and built by Western Electric.

These by-products are disposed of through Western Electric (radio equipment) and Electrical Research Products (sound picture equipment).

## *Systems Development*

The Apparatus Development group, having produced a retard coil, let us say, goes on to some other piece of equipment demanded by the Bell System. It is primarily concerned with pieces of apparatus, *per se*. But these isolated components must be put to use. Of course Western Electric builds the retard coil and sells it to the associated companies, if they are interested. But it can also take that retard coil and put it with some other product of the Apparatus Development group to make an assembly. And the design for that assembly will no doubt come from the Systems Development group.

Broadly speaking, this group engineers communication systems which combine apparatus in an economical manner to operate efficiently. Power equipment, and other apparatus and circuits essential to the control, switching and supervision of communication networks are designed by this group. Furthermore they study current design; they prepare information necessary for the manufacturer and installer. Thus Western Electric gets detailed (very detailed) instructions as to how to build a repeater, what goes into it, where the parts are to be located, how to wire it up, how to inspect and test it. Similarly the installation men, who finally put the repeater into service, get instructions for this installation, and test, and maintenance.

The Systems Development groups are broadly divided into two divisions, composed of three large groups engaged in development work and three smaller groups who make engineering studies. On the development side, one large group is concerned with central office switching equipment, and all the related complex circuit design. Other men work on toll development which leads, naturally, to more efficient methods of working the existing and future conductors (multi-channel systems, carrier current, etc.) Repeaters (voice and carrier fre-

quency) for these telephone systems and for telegraph circuits come from this group. Direct-current, voice-frequency and carrier-frequency telegraph systems form part of the work developed in this portion of the System Development department.

Until the merger into the Laboratories of Development and Research groups of AT&T in 1934, the three engineering groups of Systems Development were part of "D & R." Their responsibilities, described by their title; Local Central Office Facilities, Toll Switching Facilities, and Telegraph Facilities, are directed more towards the economic problems of annual costs and utilization of facilities than toward those incident to development and design.

These men attempt to envisage the switching and equipment communication art, to foresee its needs and trends and to bring desirable lines of development to the attention of their colleagues in other branches of the organization. From these groups come, most generally, interpretation of requirements for switching systems from those of a small PBX to the largest dial switchboard, from teletype exchange to the telephotograph system, for toll switching and signalling.

Finally there is a group which is responsible for the assembly of all the elements of a complicated system. It handles the design of power equipment. It makes trial installations, whether local or toll equipment, whether wire or radio, or teletype, or telephotograph, or telegraph equipment of new or special characteristics. Installation methods, specifications for the manufacture and installation of the equipment, and for the assembly procedure—all come under the control of this group.

Another group of erstwhile AT&T "D & R" men, now at the Laboratories, is the Transmission Development department. It develops and establishes operating standards for transmission and other functional operations of communication. On the basis of its studies of possible needs, many important developments have been undertaken, and carried to completion. It has departments concerned with general transmission design, transmission quality of telephone sets and circuits; radio transmission development; transmission theory, mathematical analyses, noise and crosstalk prevention whether of room noise in central telephone offices or noise induced by crosstalk in transmission circuits; and finally

it has groups concerned with toll transmission development including all problems of long distance transmission of signals or speech.

It is the responsibility of this group for example to apply the mathematical tool of probability to see how many circuits will be needed in ten or twenty or more years, and to urge the research groups to get busy on a project which in 1946 or 1956 will carry the expected load.

Thus in 1918 it was proposed that a cable be put through from New York to Chicago, to take care of the natural expansion of service expected and to obtain greater freedom from interruption by storms. To depend upon increasing the number of wire lines to take care of growth in New York-Chicago traffic was not the way to tackle, in advance, this problem. The cable was most costly, but ultimately more economical.

A thousand miles of cable, however, with its repeater stations every 50 miles was a big project. It brought up problems not found on shorter haul circuits. For example, the temperature between New York and Chicago might be radically different, in fact, there might be several extremes of temperature at various places along this thousand-



*Oscar: Telephone transmitters as ears tell what a human would hear in Oscar's place. He is an important laboratory assistant*

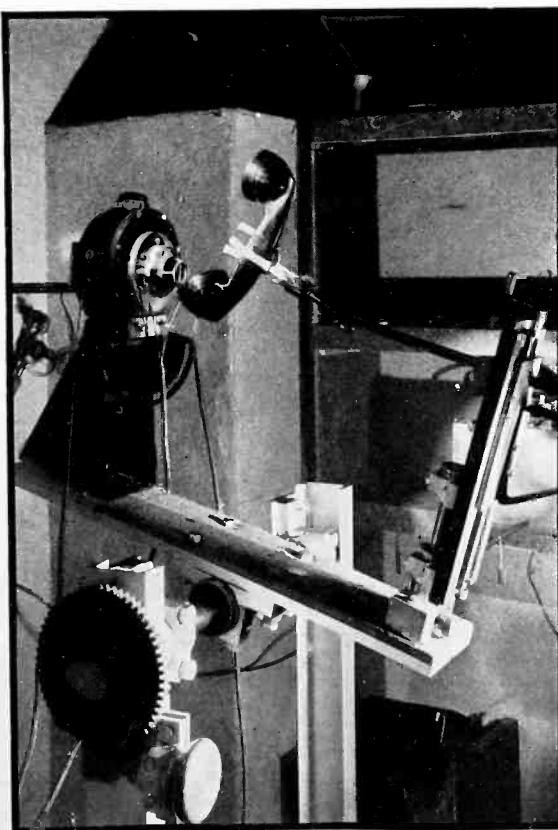

*Artificial mouth: Testing a new handset transmitter with a dynamic receiver as the source of sound*



*Fatigue testing: This machine operates the contacts in handset mountings, under conditions simulating actual use*

# PERSONNEL

mile route; and a variation in temperature causes a variation in the transmission characteristic of the wires within the cable. If the loading coils, etc., were designed for one temperature, an adjustment might be necessary at some other temperature.

There was a better way—two years before any of this cable was to go into service, the problem of variation in temperature was tackled. The engineers suggested a pilot wire be run in the cable alongside its conductors for two hundred and fifty or so conversations. As the electrical characteristics of these conductors changed with temperature, so would those of the pilot wire. Since this wire would carry no conversation—its inductance, resistance and its capacity could go up or down as it pleased. In exchange, however, it would effect corresponding changes in the circuits. If the attenuation went up because of some change in weather, the pilot wire would increase the amplifier gain at the repeater stations and the overall effect of this weather change would be zero.

The point is that long before the cable was to go into service, men were at work on problems that would arise—and the Transmission Development groups saw those problems and requested, long in advance, a solution.

Another former AT&T group concerns itself with the protection of the Bell System circuits from interference and hazards whether of lightning or inductive coupling with neighboring power circuits. This department cooperates on a joint committee of the Edison Electric Institute and the Bell Telephone System in the study and coordination of mutually proper procedures.

**W**ITHOUT doubt the most interesting part of any organization is the body of men in it. Men as persons, men as brains, men as directors of other brains, men who earn their keep by dexterous and cooperative application of their minds and hands—these are always the units by which problems are found, formulated, solved. In this respect there is probably no more noteworthy body of scientific men in the world than the personnel of the Bell Telephone Laboratories. Consider the facts: Of the 4200 employees of the Laboratories no fewer than 1500 are rated as “Members of the Technical Staff,” which means that they are trained specialists, many of them the leading authorities in their fields. Over 120 different colleges and universities are represented in the academic degrees possessed by these “Members of the Technical Staff.” In sheer numbers and nominal technical training therefore, the group of engineers and scientists working in the Laboratories is outstanding. Equally striking is the breadth of interests and occupations. From pure mathematicians, fully familiar with both esoteric and practical applications of numbers and symbols, to pure empiricists who measure the “tackiness” of a new adhesive, these men as a group might be guessed to know more about electrical com-

munication than anybody else. But they also know a great deal about chemistry and physics, not only as they are applied to communication but also for their own sweet sakes. And some of them are among the best expositors of science, both technical and popular, now writing.

The initial problem is selection of the men. The technical staff of the Laboratories has been recruited from many sources over a long period of time. Some have grown up with the Laboratories from their beginning in 1907, a few have come in from other industrial jobs, but the majority entered the Laboratories directly upon their completion of technical school or graduate school courses. The manufacturing organization of Western Electric and the plant of the operating companies have proved excellent recruiting ground, especially for men who must understand how to apply developments to the System as a whole. Many men have come from teaching or from academic research laboratories.

Once chosen, the men must be placed where their abilities can be used to advantage. In many cases this is easy; the man has a special aptitude readily classifiable. Or he may have a preference for a certain kind of work. In this case he is usually given a chance to follow his bent. Later, if his guess is wrong, he may, on his own recommendation, be transferred to some other department. Some men are transferred as many as six times before they find their niche; but in most cases one or two transfers suffice to find the proper place. But it should be noted that the man's own preference is always considered; usually it plays the major role in adjusting each man to his work. Obviously men must be found to do all the jobs the Laboratories have to do; but no man is forced to work on problems which bore him, or which he finds too difficult or too easy.

Once selected and placed, the man's interest must be kept up and his ambition stimulated. The stimulation comes from several sources. Most obvious are advances in salary

*Instructions for the field: Making a movie of the correct way to make and apply mortar bandage joints. Reproductions of the movie are used to instruct the field forces of the Bell System*

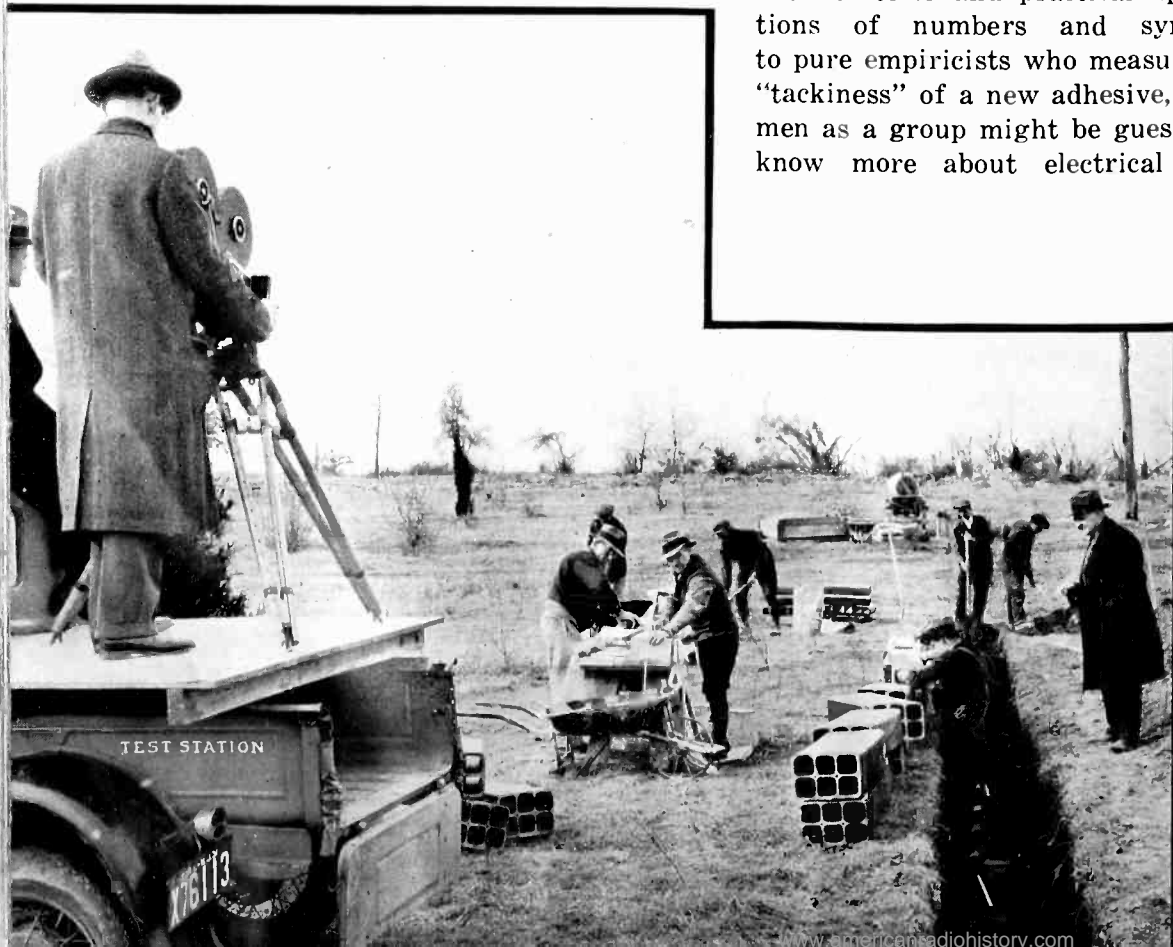

and responsibility. But an equally important factor is broadening and deepening of interests through contact with the other members of the staff. The administration of the Laboratories has wisely fostered this latter opportunity with a comprehensive out-of-hours educational program. Each year there are more than a thousand registrations in courses given by Members of the Staff for the benefits of other Members. The courses are taught between 8 and 9 a.m. and between 5 and 6 p.m. several days a week. They cover a wide range, corresponding roughly to the graduate courses in college on subjects such as differential equations, telephone systems, carrier telephony, vacuum tubes, filters and networks. Material presented in these courses has been published in books which have found wide use in colleges. Examples are "Transmission Circuits and Telephonic Communications" by K. S. Johnson, "Speech and Hearing" by Harvey Fletcher, "Probability and Its Engineering Uses" by T. C. Fry, "Transmission Networks and Wave Filters" by T. E. Shea, and "Theory of Vibrating Systems" by I. B. Crandall.

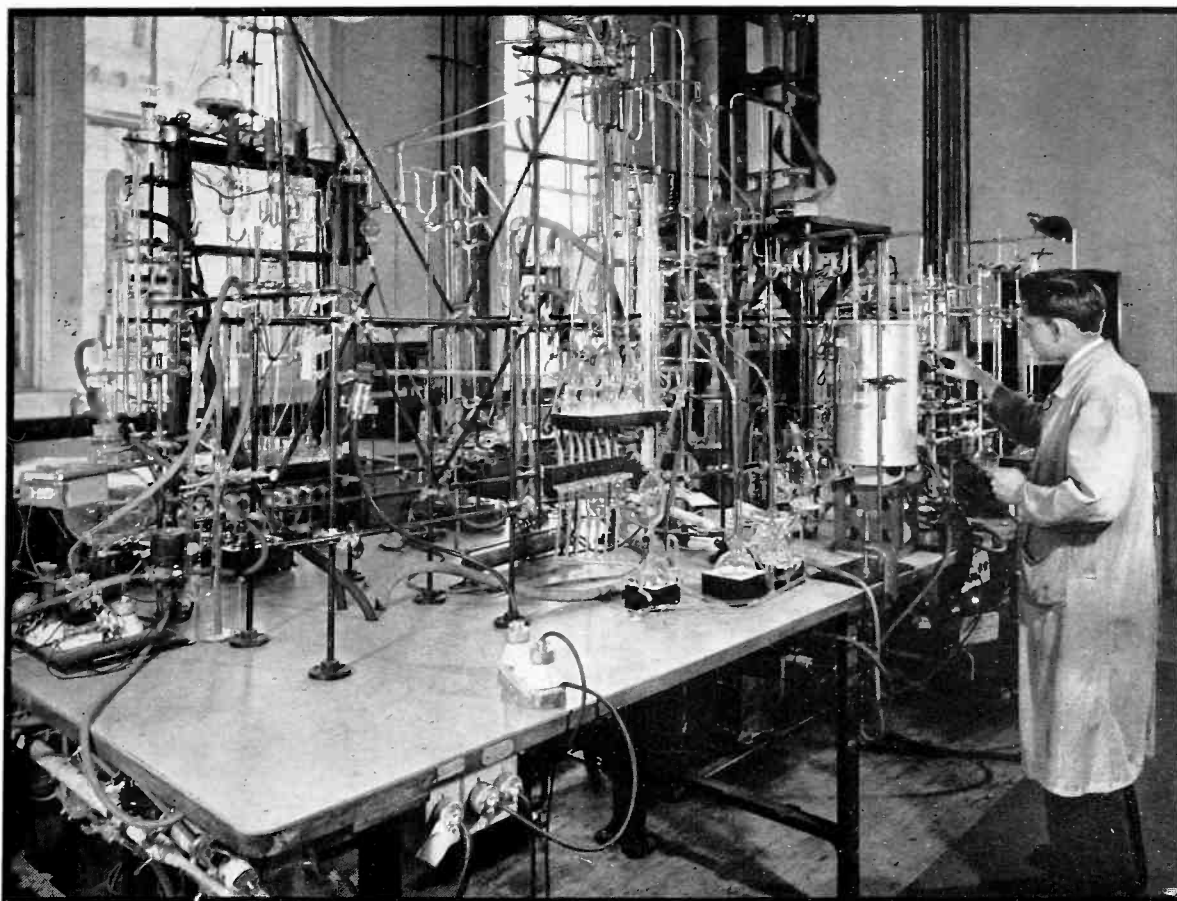

Chemist's heaven: Apparatus for analyzing minute quantities of gas found in vacuum tubes

late afternoon classes in mathematical physics and theoretical chemistry. Many of these men obtain Master's degrees and quite a few have attained the Doctor of Philosophy.

Employees who are not members of the technical staff are also given every opportunity to improve their educational background. Many of these are young men of high school preparation who entered the Laboratories as draftmen or laboratory assistants; in general they are of the caliber which would have completed technical college courses had not financial or family reasons prevented. So-called "Student Assistants' Courses" held one hour a day on company time, require two or three hours' study on the student's own time. These courses train men to accept duties of increasingly technical nature, so that eventually they have schooling at least in electrical communication, substantially equivalent to a college course. Many of these boys have obtained leaves of absence, attended colleges nearby and earned technical degrees; several accomplished the same result by going to night school. This type of training was discontinued during the depression, but has been rein-

stated to some extent. The engineering shop maintained for many years a standard apprentice course for instrument makers. This had to be given up during NRA but boys now recruited for that work are given instruction in shop mathematics, drafting and the like for one hour a day.

A major problem in personnel direction is the rewarding of a conspicuously commendable piece of work by an individual or group in the organization. Examples are important patents issued to members of the staff. These patents are assigned to the Bell Laboratories; they are Bell System property. In many other large companies this practice has been the root of much difficulty but the problem has never led to ill-feeling in the Laboratories. The reason is that the men realize that invention is merely part of their job, which is cooperative in nature; even if the act of invention is entirely individual the rest of the group has cooperated at least to the extent of removing the distracting problems from the inventor's concern. In most cases the cooperation is much more active than that. There are usually many men shaking the tree when the plum

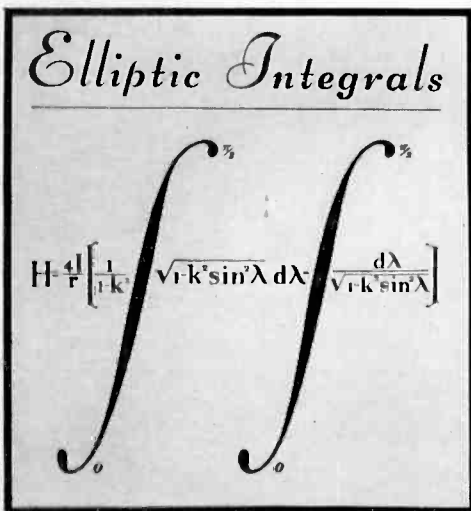

Elliptic integral: A complex expression necessary for a simple answer, used by the mathematicians to compute the magnetic field outside the spiral grid of a vacuum tube. From an educational poster of the Laboratories

As part of the educational program, an arrangement with Columbia University has been made so that a dozen or so young men each year are released from company duties two or three times a week to attend

# PROJECTS



*Materials: A corner of the mechanical testing laboratory, showing telephony is not all wires and sound*

drops on the inventor. A man entering a new field may make an invention every few days; and get patents on them. A man in a field long established may make contributions to the System which are of even greater value, but which are not inventions and therefore not patentable. These facts are well recognized by the Laboratories.

In general, salary increases come primarily from a man's ability in cooperative endeavor rather than for conspicuous individual accomplishments. This emphasis on cooperation is not only sound logic in an organization of so many different types of men and work; it also results in better work by each individual. And in general salary considerations are much less important in this group than in most non-technical groups of the same size. The men are grouped together in a con-

genial atmosphere, associated with others of similar if diversified interests and ambitions, and they have satisfaction in accomplishment which apparently takes the place of more material rewards.

**H**AVING all this physical and mental equipment, it must not be supposed that work for the Laboratories rises out of thin air. Discoveries are made, it is true, that change radically past lines of thought and procedure and provide a new line of endeavor—the Black feed-back amplifier is a good example. But discoveries are rare; and if the scientists and engineers of the Laboratories sat around making discoveries or waiting until someone else popped up with a discovery, there would probably not be enough work to go around.

Projects on which the Laboratories work arise in various ways. Someone may invent a problem—that of transcontinental telephony, for example. Or a broad subject may arise out of the knowledge that a single pair of wires will carry a limited number of voice frequency channels and the knowledge that sooner or later there will be more conversation than wires to carry them. This is a general problem. How is it to be solved? One answer is to multiplex a pair of wires so that one set of conversations can use them in series and another conversation may use the pair in parallel against the ground (or a similar pair) as the return. Or carrier frequencies may be used with the result that each carrier channel on each pair of wires will carry two, four or a dozen conversations. Still another answer is to invent a new type of wire, a new conductor, that will increase the number of conversations per pair. Such is the coaxial cable.

Another source of projects for development lies in the recognition of certain broad fields in which investigations should be carried out in the expectation of profitable results. These fields may be broad, as for example electronics, insulating materials, magnetic materials—or the fields may be relatively narrow, but still capable of saving the System money or providing better service for the same price. Here lie inves-

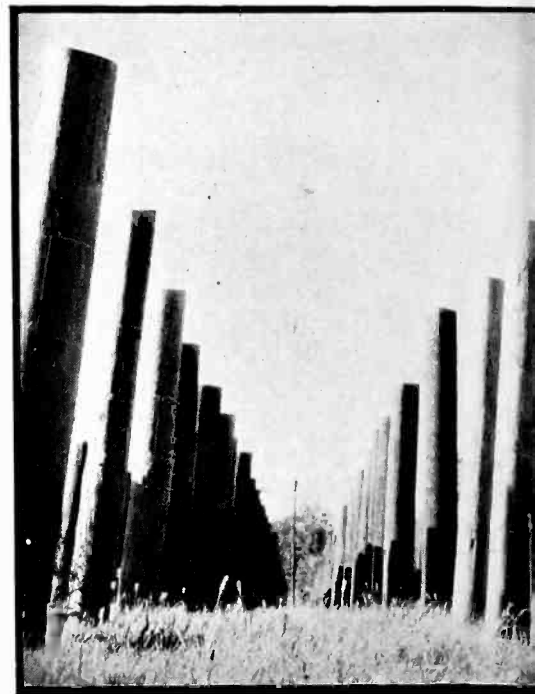

*Pole plantation: Decay-testing*

tigations leading to better loading coils, transformers, relays, microphones and the like.

There are broad fields in which research goes on continually, often paralleling the work taking place in some other industrial or collegiate laboratories. For the Bell System must be abreast of scientific advances and discoveries in every known field. Thus engineers responsible for some project consider each day's increment of knowledge to see if it can be profitably applied to the problem at hand. If, for example, someone somewhere invents or discovers a new magnetic alloy, its properties are immediately studied and designs of existing electromagnetic apparatus are reconsidered in the light of the newly available materials.

Many projects arise from the immediate and definite needs of the operating company (AT&T). Other projects arise through contact with the manufacturing company (W.E.) and new methods of manufacture and inspection may thus arise.

One source of research projects, and perhaps the most fruitful of all, is research itself. Research is a branching process. As new information is uncovered, as new relationships are worked out which tie together physical phenomena so as to make them more understandable, new leads for research are unearthed. Finding the answer to one question whets the appetite of the investigator to study other questions



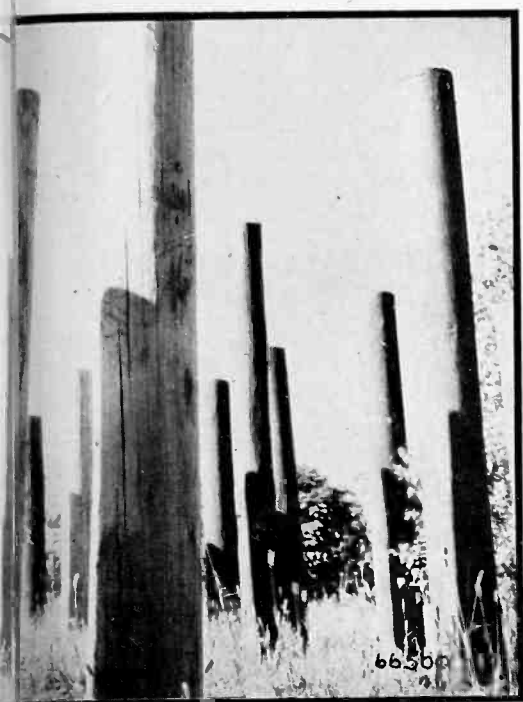

at Chester, New Jersey

which have occurred to him in his course of study. The path to the answer to the main problem may be strewn with unanswered questions which may be cleared up later, by-products which may lead to important new designs or discoveries.

The test of one invention stimulates other inventions. The problem of the Laboratories' executives is not to find work to do but to select from all the promising leads those which seem to promise most ultimate usefulness to the art of communication. It is in this selective function that the experience, judgment and ability of the executives are so important.

As Dr. Jewett, the President of the Laboratories said, in his reception of the Franklin Institute medal, part of his responsibility is that of "applying critically to results and proposals, the tests which come with age and much sad experience." To maintain proper atmosphere for cooperative endeavor, to enable many men to develop the maximum of their creative scientific ability, to avoid waste motion and loss of effort by carrying out the less important rather than the more important research and development projects, those are the problems of the Laboratories' executives. Dr. Jewett still sees "great vistas of possibility for scientific research in the fields of telephony and its sister services" and says that it is still true in this field that "as it has been for many years past, each advance opens the way to

yet other advances."

Now, having a problem, how is it solved?

Various groups interested in a project (which may have its origin in some individual's mind) get together to see (1) should the project be started, (2) how shall the work be divided, (3) how much will it cost. If, as the scheme goes up the line, getting up higher and higher in the hierarchy of supervisors and department heads, it seems that something worth while will come of it, a "case number" is assigned, the project (or "case") is opened, an appropriation is made, the portion that individual groups will carry out is determined and work starts. Ultimately a broad project will involve practically every department in the Laboratories. Or conversely, a small project may merely be added on to a "case" already under investigation.

Consider the coaxial cable, now being installed between New York

and Philadelphia. This cable differs from the ordinary bundle of wires covered with a lead sheath in that it has only two conductors, an inner wire supported on insulators in the center of a larger conductor which is grounded. The exact characteristics of such a cable depend upon the relative diameters of these two conductors, but under any conditions it will pass an extremely wide band of frequencies.

Now what does this mean? A single pair of open or cabled wires will carry, at voice frequency, one channel as a maximum. Here the currents traverse the two wires in series. But if a second pair of conductors is provided (four wires) three channels are available. Ordinarily the voice frequencies passed are from 250 cycles to about 2700 cycles. If a telegraph channel is provided requiring no frequencies higher than 80 cycles, on top of the voice currents may be superposed a

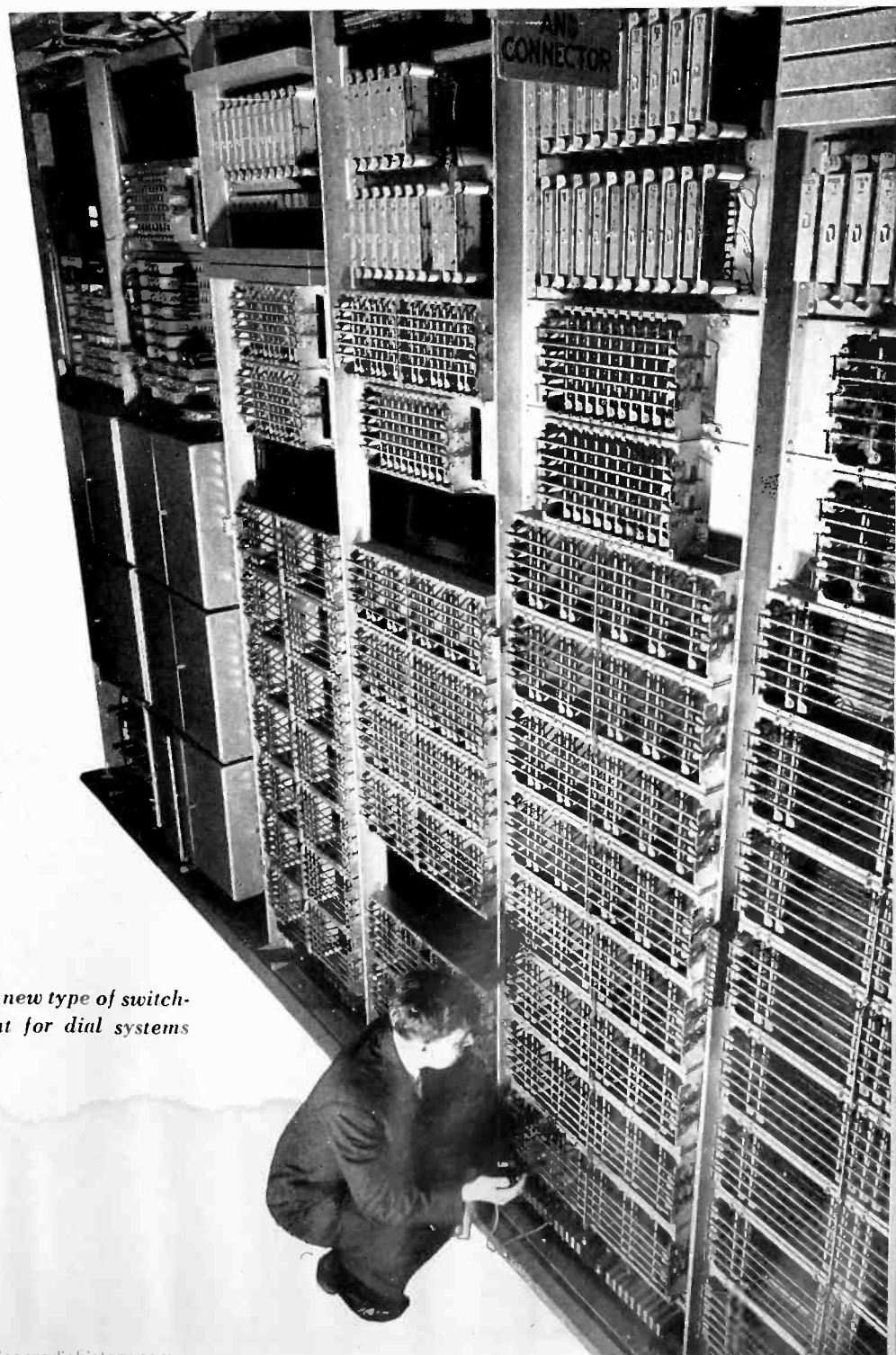

Crossbars: A new type of switching equipment for dial systems

telegraph message. Thus two pairs of wires will carry 3 telephone conversations and 2 telegraph messages. This is the limit at *voicé* frequencies.

Now on open wire, and cable to some extent, we may use "carrier" frequencies, say 5 to 30 kilocycles. In this region there may be 6 one-way channels each 2.5 kc. wide; on a pair of these channels we may have one telephone conversation. Thus by going to carrier we have increased the number of channels that may be carried on a single pair of wires from one to four and on two pairs of wires from 3 to 9.

The coaxial cable, however, will pass a band of frequencies one million or more cycles wide. On it we may have 200 one-way channels each 2750 cycles wide. Anyone can see that there is some sense to a system employing a coaxial conductor—provided its annual cost per channel can be made less than that of other types of conductors.

The coaxial system was born in the mind of an engineer in the Transmission Development Department. It was studied mathematically to determine its theoretical possibilities and some preliminary experiments were done to check the theory. The results of this study were submitted to the Research Department for further study and experimental development. A group of research workers was assembled to work on the problem of a coaxial system and explore its possibilities in the laboratory. Soon the proposed system began to change its appearance. It was found that a much smaller structure could be used for the coaxial line than was first conceived. When they actually tried to build an amplifier for the coaxial system new problems were encountered for never before had engineers tried to handle such a wide band of frequencies in one amplifier. New types of corrective circuits to minimize distortion and crosstalk between channels had to be developed by mathematicians using new methods of mathematical attack. New vacuum tubes had to be developed to meet the requirements of the amplifier; the transmission characteristics of different types of line construction had to be studied; new materials had to be developed to give required mechanical and electrical properties.

Research on this project is still

in progress and very far from completion, but already the Apparatus Development and Systems Development Departments have been called in to develop and build the structures required for a trial installation. Meanwhile the Transmission Development Department follows the whole project from the transmission point of view and continues to give broad consideration to this system in relation to other possible systems of transmission with which it has to compete. Out of this effort will come, Bell engineers believe, a valuable addition to the facilities of the System, but in addition, out of it will come a host of research problems which are likely to engage the various departments for several years to come; and out of the research which ensues will come inventions and knowledge applicable to many other parts of the telephone business.

One department frequently provides a project for another. Often the needs of a Bell System operating company furnish the Laboratories a project which may have widespread ramifications before the case is closed. A case in point was that of cable corrosion.

At some points on the Pacific Coast, underground cables in creosoted wood ducts were failing in service due to corrosion of the cable sheath. Electrolysis was quickly eliminated as a cause, and no unusual acidity was found in the soil. Since corrosion did not occur when the ducts were flooded by water, but

rather when water dripped upon the cables, it was suspected that some gas in the ducts dissolved in the drops of water and rendered them corrosive. This theory was supported by analysis of the corrosion-product. Accordingly an instrument for collecting and analyzing the air in the ducts was devised, and it was soon shown that carbon dioxide and acetic acid vapors were present in definitely corrosive amounts. Investigations at the plant where the ducts were made showed that the particular wood used—Douglas fir—contained considerably larger quantities of acid than other varieties which had given no trouble. Laboratory studies of this wood showed that the acid could be neutralized by ammonia gas, and a method of flowing this gas through the ducts was developed. After it had been applied, trouble from sheath corrosion practically ceased.

One of the earliest, and perhaps one of the biggest projects arose from the visit of the then Chief Engineer of AT&T to California in the days before a person in New York could talk to one in San Francisco. General J. J. Carty came home (this was in 1909), wrote a memorandum to the vice-president to whom he reported, recommending that work be started on a trans-continental line. He wanted men and money to develop a new repeater (one was then available but not satisfactory) which would restore the strength of speech currents as they

*Breadboard: Apparatus development laboratory*



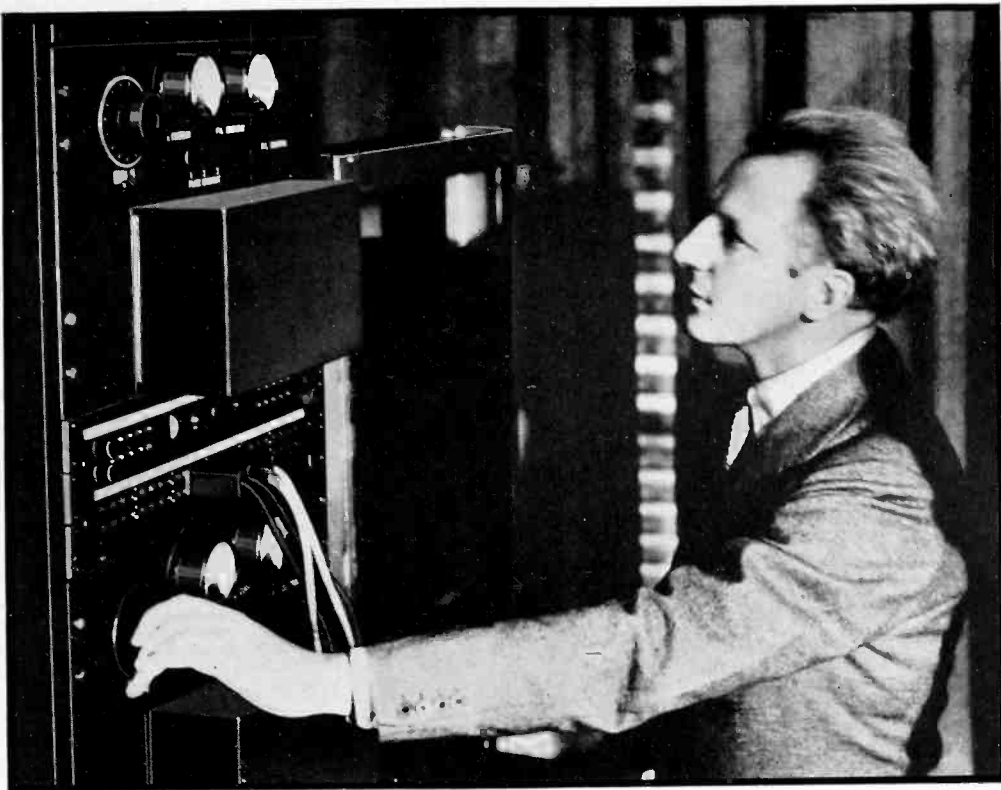

*By-product: Dr. Leopold Stokowski at the controls of an amplifier developed at the Laboratories for high quality reproduction of music*

were weakened by transmission over great lengths of wire.

Physicists and engineers were hired and put on the job of solving the underlying problems. Working under the leadership of Dr. F. B. Jewett and Mr. E. H. Colpitts, the solution was found. It involved the development of the deForest audion into the modern high-vacuum electron amplifier-tube, now made and sold at the rate of nearly 80 million a year. In 1914 the transcontinental service was inaugurated.

In General Carty's original memorandum he stated that the problem of long-distance radio-telephony might be solved as a result of this project of the transcontinental system. And sure enough, in 1915 voices were sent by radio from Arlington, Virginia to Paris. Thus the groundwork was laid for the present system which connects the United States with Europe by radio telephone.

**S**OME mention has been made of the fact that the *raison d'être* of the Laboratories is to improve the art of telephone communication, by wire or radio; and that certain by-products have arisen from the research carried out on this premise. One of the first was the public address system made possible by the

improved forms of microphones, new amplifiers, and finally by the first real loud speakers. All radio men whose experience dates back to 1921 will remember the demand for a loud speaker. The horns of that period were simply telephone receivers attached to a metallic spout. Western Electric sold one; then came its 10-A, a power-operated horn which had a ring-shaped conductor vibrating in a magnetic field (battery-operated) and driving a diaphragm. Finally came the cone speaker, the 540-AW, another by-product of the Laboratories.

One of the questions that was agitating commercial men in 1923 was this: "Will the radio supplant the phonograph?" In a short while it seemed certain that such was going to be the case. But the amplifier made it possible to record and reproduce music and voice currents with a degree of tone fidelity not approached by the old phonographs. Using the electrical apparatus developed for this purpose, Bell engineers demonstrated to the phonograph companies the way to resurrect their lagging business, the way (finally as it turned out, the *only* way) to compete with the radio.

Thus the Orthophonic phonograph was born. Its mechanical apparatus, stylus, tone arm, sound chamber



*Life test: 304-A's in a fifteen-meter oscillator of unusual designs*

were carefully designed so that, as in an electrical system, its "impedances were matched" to give efficient operation and to extend the frequency range much beyond the capabilities of the older instruments.

Sound pictures really got their start in 1927, with the production of Al Jolson's *Jazz Singer*. This was sound on disc, the synchronism between film and record being controlled by elementary methods. In 1928 Hollywood took the plunge; it bought sound equipment in such amounts that the Hawthorne plant of Western Electric worked extra shifts. By the end of the year 16 recording channels were in use; but by the end of 1929 116 had been installed. Much of this equipment came from the Bell Laboratories' designs.

Sometimes it takes these by-products a long time to "prove in." For a generation or more, men have schemed to send pictures by wire. The basic groundwork was done many

years ago. But pictures by wire were not very good until the Laboratories got after the problem, when a system was developed which could transmit, from a transparency (film) a print so perfect that it was difficult to tell it from a contact print made at the transmitting end.

The Bell System envisaged a network of picture transmitting apparatus spread over the country, thus offering the public a new service. Already people could talk over wires; now they could send pictures over wires. Stations were put in at half a dozen strategic cities.

But business was slow. No one wanted to send pictures. The trouble was that you had to take the picture to the central office at the transmitting end and you had to call for it at the receiving end. Finally the machines were more or less forgotten. The picture transmission scheme was a commercial flop.

But the idea was not forgotten. The system was improved. Prints, instead of film negatives, could be used in sending. Much larger pictures could be sent and the speed was more than doubled. Finally the Associated Press became interested; a network of transmitters and receivers was installed—but with the machines in the offices of the newspapers—not at some telephone company station in another part of town. Furthermore, times had changed. The new mode in publishing was to supplement the written word by many more pictures; and like the words, the pictures must travel fast.

Thus the picture transmission system, for which there seemed to be no market, finally found its niche.

As far as the Bell System is concerned, broadcasting sprang from its experiments at Deal Beach, New Jersey, on ship-to-shore radio telephone. Engineers at this remote laboratory put on music and talks at night after the day's work was completed, getting reports of reception from amateurs who listened on the long wavelength used. This was shortly before KDKA got on the air. But the telephone company was not interested in transmitting music—this was not telephone communication. The engineers did not push this feature of their work—and thus the Bell System missed the chance of being the world's first broadcaster.

Its speech-input equipment kept pace with the demands of the broad-

casters, and when Hollywood wanted equipment, it was ready. When broadcasters adopted the idea of remote pick-up (nemo) it was natural that telephone lines would carry the program to the studio.

## A TELEPHONE CHRONOLOGY

- 1876 Bell's first telephone patent. First overhead line conversation, 2 miles Boston-Cambridge.
- 1881 Boston to Providence overhead line, 45 miles. Underground cable, one-fourth mile.
- 1884 Conversation by overhead line, New York-Boston, 235 miles.
- 1892 Overhead line, 900 miles, New York to Chicago.
- 1902 "Long distance" cable, 10 miles, New York-Newark.
- 1906 90-mile underground cable, New York to Philadelphia.
- 1913 2600-mile line, New York-Salt Lake City. Cable, Boston to Washington, 455 miles.
- 1915 Transcontinental line, 3600 miles. Radiophone, Arlington to Paris, to Hawaii.
- 1921 Deep sea cable, 115 miles, Key West-Havana. Telephone, Havana to Catalina Island, 5500 miles.
- 1922 Telephone to S.S. America, 400 miles off shore in the Atlantic.
- 1923 Transatlantic radiophone, New York to Southgate, England.
- 1924 First picture transmission over telephone circuits, New York to Cleveland.
- 1927 Regular transocean telephone service. Wire-radio television.
- 1929 Ship-shore phone service.
- 1930 Two-way television.
- 1931 Teletypewriter exchange service.
- 1933 Stereophonic music transmission.
- 1935 Round the world phone conversation.

Another by-product arose from the natural efforts to make the telephone circuit the most intelligible possible. In the early 1920's articulation tests were started; listening crews put down the words out of a series they could understand. But there must be some test of the listening crew's ears. And so an oscillator, an attenuator and a head receiver were de-

veloped for this purpose. This was the early form of the "Audiometer" which is now used to test the hearing. Special headsets—and deaf aids—for the hard-of-hearing resulted from this remote start to improve the understandability of telephone conversations.

The continuing nature of the work of the Laboratories, both in improving the telephone art and in producing by-products of note, may be exemplified by two recent accomplishments. On the 17th of August, Dr. Leopold Stokowski presented, as guest conductor, a symphony concert played by 100 musicians in the Hollywood Bowl, Los Angeles. On the conductor's stand were the controls of the most elaborate musical reproducing system ever installed. For when Dr. Stokowski accepted the commission of leading the orchestra, he insisted that the three-dimensional (stereophonic) amplifying system of the Laboratories, demonstrated a few years ago at Constitutional Hall, Philadelphia, be brought out of the closet, brought up to date, and brought to Hollywood.

And so the Bell engineers who had developed the project hid themselves to California with engineers of ERPI to see that the orchestra's full volume and tonal range, in its full space relationship be transmitted to all sections of the audience at the Hollywood Bowl.

Finally, early in 1936, came the announcement that a new mode of transmitting electrical energy was being investigated at the Laboratories. The new conductors were called "wave guides" and they consisted of nothing more than hollow metallic pipes. If extremely short radio waves (15 cm.) are generated at one end of such a pipe they travel along it and may be detected at the other end. No return conductor is necessary; and a certain type of transmission has been found in which the attenuation decreases as the frequency is increased. This is a phenomenon not found in any other wavelength region that has ever been explored.

What good the phenomenon will prove to be cannot be guessed now. But it is certain that in investigating it, the Laboratories are looking into the future, possibly preparing a new means of communication which may greatly extend the utility and availability of telephone service.

## Grid Glow Tube Measures Commutator Roughness

By A. M. HARRISON,

Power Engineer

Westinghouse Electric and Manufacturing Company

THE problem of obtaining a visual indication of commutator roughness presents an interesting application of a grid glow tube. The roughness of a commutator can be measured by observing the variations in the brush drop voltage when current is passed through a brush riding on the surface of a commutator which is rotating at operating speed. The brush drop varies with the roughness, as is shown by a typical oscillograph (Fig. 1), and the magnitude of the voltage peaks determines the degree of roughness of the commutator. The relation between brush drop voltage and roughness can be more easily appreciated if you consider the case of a very high bar striking the brush so hard as to knock the brush from the surface, interrupting the circuit momentarily. In this case,



Fig. 1. Oscillogram of commutator roughness

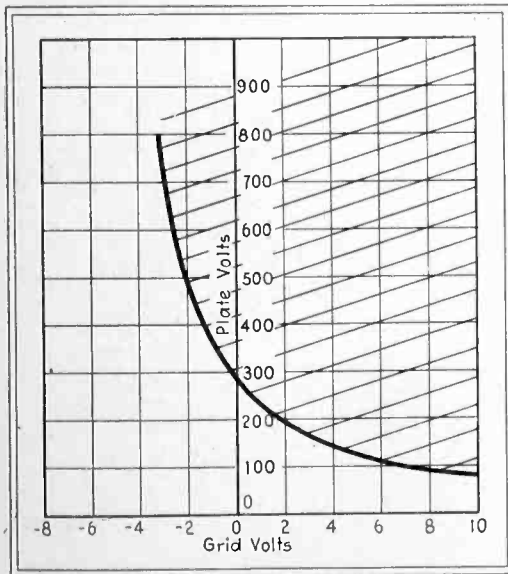

Fig. 2. Grid-glow characteristic

if the applied voltage of the circuit were 110 volts, the brush drop would show a peak of 110 volts, whereas the ordinary drop if the surface were smooth would be of the order of magnitude of 2 volts. Smaller roughnesses produce voltage peaks intermediate between these values by disturbing the brush causing it to spark, or by causing variations of the pressure between the commutator and the brush. Formerly, the oscillograph was used to record the variations in brush drop voltage, but it has two serious disadvantages: first, the degree of rough-

ness cannot be determined at once because the films must be developed and calibrated to determine the value of the voltage peaks; and second, the oscillograph element has a certain inertia which prevents it from recording the maximum voltages because the frequency of the pulsations is so high that the oscillograph cannot follow fast enough. The use of a grid glow tube was suggested by the Westinghouse Research Laboratories as a simpler and more direct method of obtaining the maximum voltage peak and corresponding maximum roughness.

Fig. (2) shows a characteristic curve of a grid glow tube.

When the grid and plate voltages are such that the intersection of their coordinates falls in the shaded portion, of which the curve is the boundary, the tube will give a bright blue glow discharge, or to be more specific, with a voltage of five hundred (500) volts on the plate, the tube will glow if the grid voltage is greater than minus two (-2) volts, (i.e., minus one (-1) or any positive value). In the instrument as developed for practical use, the grid glow tube is supplied with a variable grid voltage which can be varied in steps of one (1) volt from zero to one hundred (0-100) volts. The brush drop is connected in series with this voltage and in opposition to it. When it is desired to measure the peak voltage of a particular brush drop, the variable grid voltage is set at some high value and decreased gradually by turning the dials until the glow discharge is obtained and the reading noted. For example, assume the voltage at which the glow discharge took place to be 17 volts. From the curve (Fig. 2), it can be seen that if two volts bias was necessary to cause the tube to glow; therefore, the peak voltage occurring in the brush drop must be fifteen (15) volts or the difference between seventeen (17) and two (2). In practice, in order to guard against what is technically known as drift of the tube (this means a slight change in the tube characteristic with time and temperature), a double pole switch is used so that one reading can be taken with the brush drop connected and one with the brush drop disconnected. The peak voltage is then the difference between the two readings.

The grid glow tube has two great advantages: First, the maximum commutator roughness can be judged instantly by simply observing the values of grid voltage when the tube glows, and second, it has no mechanical inertia and can follow voltage peaks of practically any frequency, thus giving a true measure of the maximum roughness of a commutator.

The importance of this device can be visualized better perhaps by a description of exactly what it accomplishes. It measures roughnesses of the order of magnitude of one ten thousandths (.0001) of an inch when the commutator is rotating at a peripheral speed of five thousand to ten thousand (5,000-

10,000) feet per minute and at a temperature of about one hundred degrees centigrade (100° C.). It enables a designer to predict the mechanical performance (that is, the ability of the structure to remain a smooth surface under operating conditions of speed and temperature) of a commutator to such a degree that not a single commutator which has passed a brush drop test of this kind has ever resulted in a failure in operation. Every power commutator built commercially is tested by means of this instrument. It is one of the delicate measuring devices which are so essential in any development, and has played a considerable part in the development of commutators.

• • •

## New Forms of R-F Lines

THE PROPAGATION of electromagnetic radiation over a long distance in a limited, enclosed space is simple in principle, but until recently has been given little consideration. If we imagine a pipe, not necessarily straight, made of a perfect conductor, and containing a source of radiation at one end and terminated in an absorbing mechanism at the other end, it is apparent that the energy will be reflected repeatedly within the pipe, but must all eventually be received at the far end.

The Bell Telephone Laboratories have recently made a thorough investigation, both theoretically and experimentally, of this form of transmission. The results are quite different from the more familiar methods of transmitting energy. The most important characteristic is the attenuation due to the imperfect conductivity of copper tube. In the familiar concentric transmission line, attenuation increases as the square root of the frequency. In this new form of transmission, the line operates as a high pass filter, the cutoff frequency determined by the diameter of the tube. At cutoff frequency, the diameter of the tube is in the order of one wavelength. There are four possible wave forms, differing from each other somewhat in transmission characteristics. In one form, the attenuation decreases continuously as the frequency increases, a most unusual phenomenon.

A six inch line 1,250 feet in length has been used in laboratory tests. Measured results between 1,000 and 2,000 megacycles agree excellently with predicted values. The transmitter consisted of a Barkhausen or magnetron oscillator coupled to the center of a half wave radiator inside the tube. A crystal detector and galvanometer were used for reception. A resonance chamber of adjustable length may be used as the equivalent of a tuned circuit in either transmitter or receiver. A section of concentric transmission line of adjustable length serves as a wavemeter. — *B.S.T.J.*, April, 1936, and *Bell Lab. Record*, March, 1936.

# SVEA METAL

Used for Many Purposes by the  
**BELL TELEPHONE LABORATORIES**

**SOME ADVANTAGES:**

**IN ELECTRONIC WORK**

Dense structure • Low occluded gas • Freedom from amalgamation • Absolute uniformity • Light weight • Rigidity  
Lower cost

**IN ELECTRICAL CORE PARTS, ETC.**

High permeability • Low residual • Low hysteresis • High resistance to aging • Easily formed

**AVAILABLE IN ALL STANDARD FORMS AND SIZES:**

Rounds	Flats	Heavy sheets
Squares	Thin strip	Tubing

Also fine round and flat wire.

Write for technical literature and our bulletins "SVEA-ONICS".

**SWEDISH IRON & STEEL CORP.**

17 Battery Place — N.Y.C.

pend, of course, on the phase with which they started. The velocity of the electrons with a lag of 45 deg. is only about one-half the highest velocity. With a given tube the degree of amplification may be adjusted by increasing the frequency of the applied field, the cut-off being obtained for an increase of about 10 per cent, or by decreasing the amplitude.—*Ferns. Tonf.* 7: 41-44. 1936.

The interest in secondary emission multipliers is illustrated that Zowrykin's articles on this subject have appeared almost at the same time in three different languages, in the *L.R.E. Proc.* 24: 351-375. 1936; in the *Onde el.* 15 No. 173: 265-298. 1936; and in the *Zeits. tech. Phys.* 18 No. 6: 170-183. 1936.

## FARNSWORTH'S MULTIPLIERS

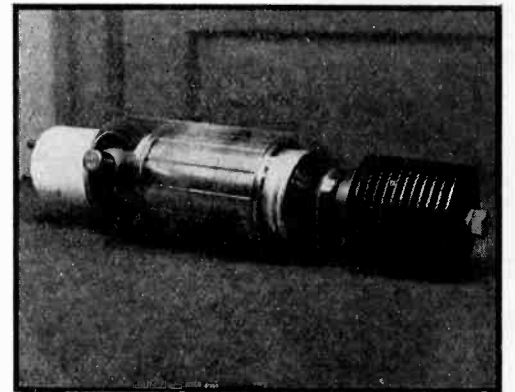

*This high power electron multiplier dissipates more than a kilowatt, hence the air-cooling fins*

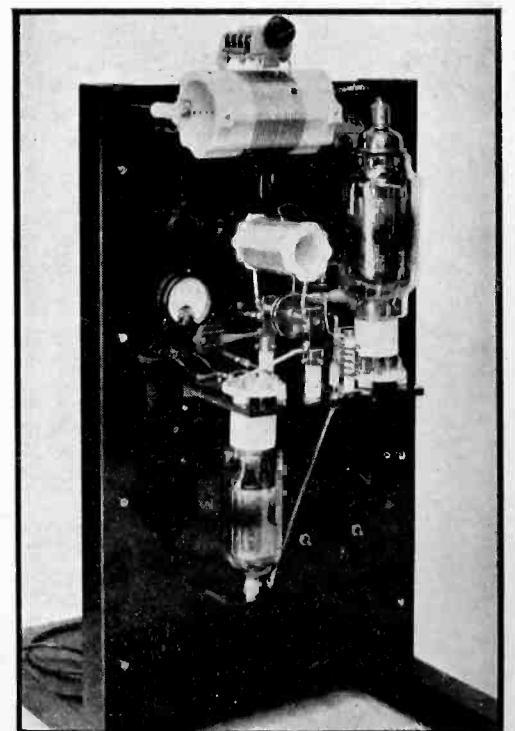

*Two multipliers in tandem generate about 500 watts of output in this arrangement*

## LEPEL HIGH FREQUENCY CONVERTERS

for

**INDUSTRIAL HIGH FREQUENCY INDUCTION HEATING APPLICATIONS  
A TYPE FOR EVERY REQUIREMENT...**

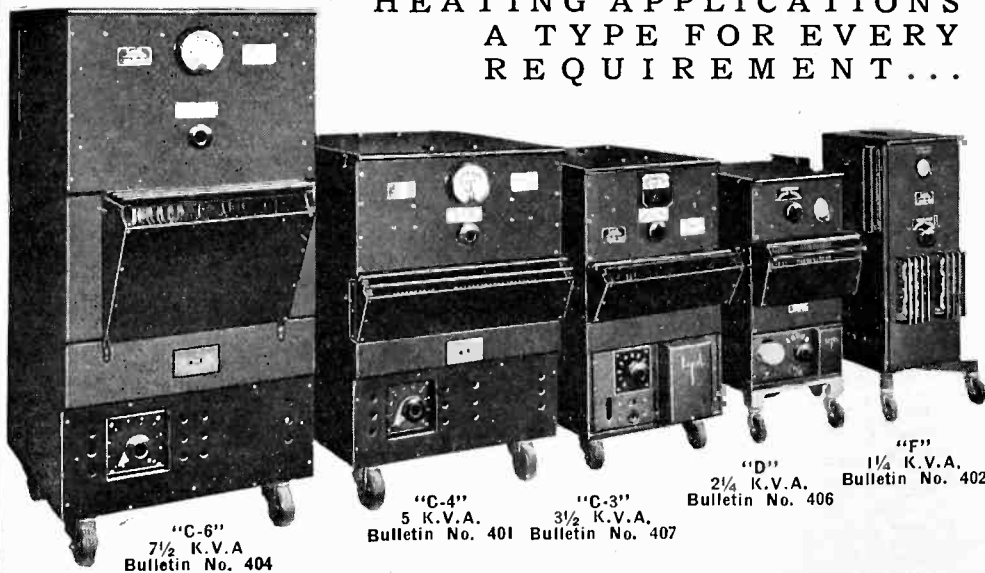

"C-6"  
7½ K.V.A.  
Bulletin No. 404

"C-4"  
5 K.V.A.  
Bulletin No. 401

"C-3"  
3½ K.V.A.  
Bulletin No. 407

"D"  
2¼ K.V.A.  
Bulletin No. 406

"F"  
1¼ K.V.A.  
Bulletin No. 402

Higher capacity Converters, Furnaces and special induction heater coil designs submitted upon application.

• • • • •  
*Write for bulletins describing new features and improvements.*

**LEPEL HIGH FREQUENCY LABORATORIES, Inc.**

39 West 60th Street

New York City

# WESTON

*keeps pace with the ...*

## INDUSTRY'S NEEDS

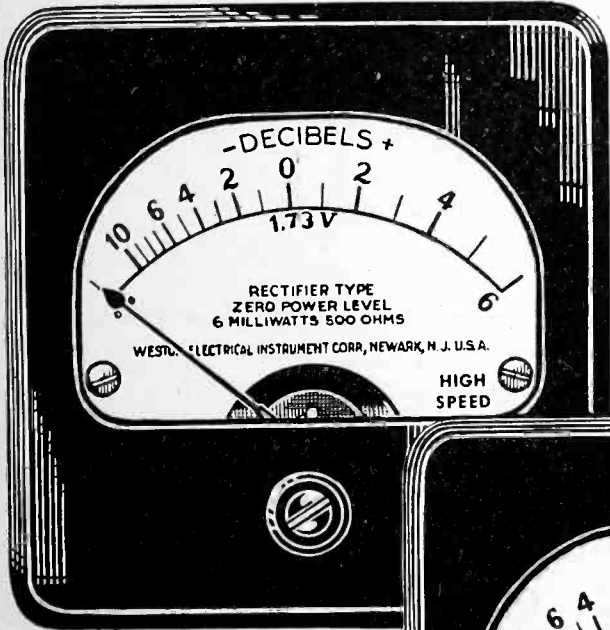

### THE WESTON HIGH SPEED DB METER

— for critical analysis of performance characteristics... broadcasting, communications, development laboratories —

*All types of DB Meters are supplied in all conventional sizes and cases ... for panel mounting or portable use.*

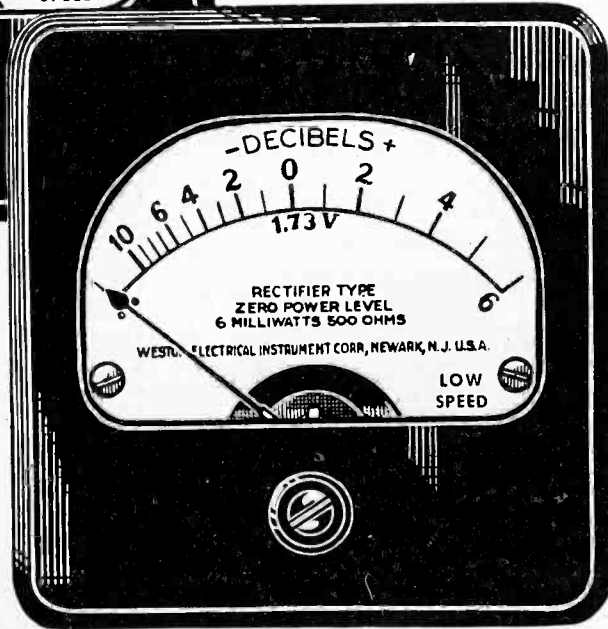

### THE WESTON LOW SPEED DB METER

— for indicating average level rather than peaks . . . sound movies, voice recording, P. A. systems —

# WESTON

*Instruments*

The development of the high and low speed DB Meters emphasizes WESTON's leadership to a high degree. It illustrates the continued and successful effort of WESTON to anticipate and keep constantly abreast of industry's needs . . . always having the right instrument available to meet each new instrument demand . . . Weston Electrical Instrument Corporation, 618 Frelinghuysen Avenue, Newark, New Jersey.

### INSTRUMENTS FOR EVERY BROADCASTING AND COMMUNICATIONS NEED!



**MODEL 642**  
A. C. VOLTMETER



**MODEL 564**  
VOLT-OHMMETER



**MODEL 571**  
OUTPUT METER



**MODEL 689**  
OHMMETER

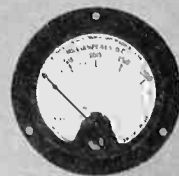

**MODEL 506**  
MILLIAMMETER

No Limit to Contacts  
and Control Applications  
with  
**RELAYS**  
by  
**GUARDIAN!**

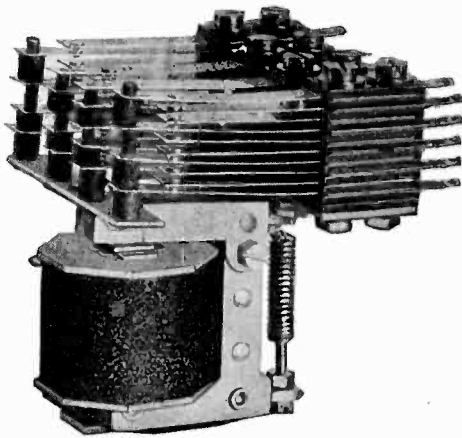

**Series 30-A. C. Relay**

This is but one of sixty relays illustrated in the new comprehensive catalog just off the press. Solve today's control problems in a modern manner. Fast—Economical—Reliable—Accurate—Rugged Relays. Built for long service at low cost. Tens of millions of operations without attention. Write today for

**FREE CATALOG**  
• VALUABLE •  
**COMPREHENSIVE**

**GUARDIAN**  
**ELECTRIC MFG. CO.**  
1625 West Walnut Street  
CHICAGO • ILLINOIS

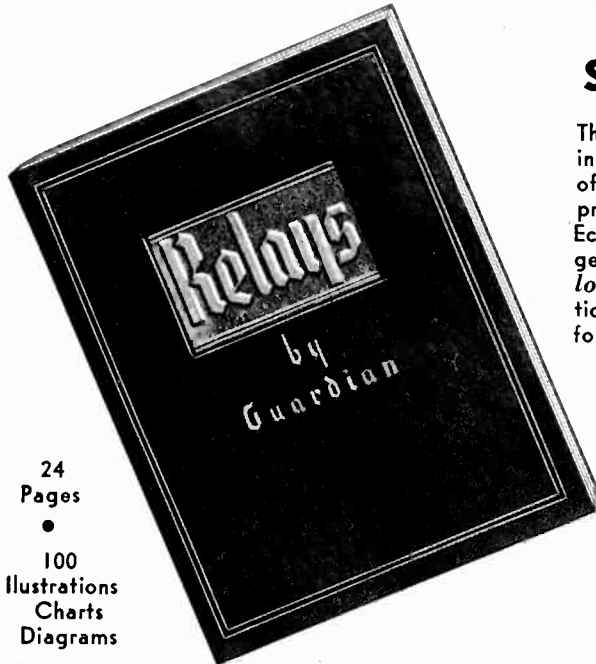

24  
Pages  
•  
100  
Illustrations  
Charts  
Diagrams

**OLYMPIC TELEVISION**

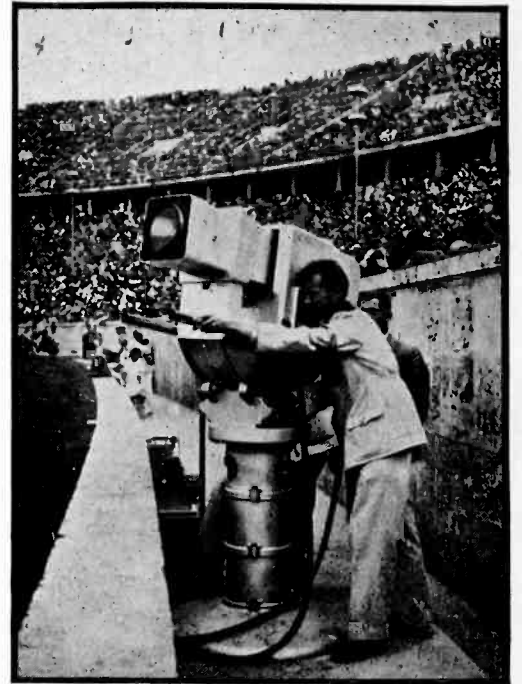

*This camera was used in the Olympic Games, Berlin, to pick up scenes which were transmitted over coaxial cable to a projection room in the German Postoffice Headquarters*

**Radio Waves Change Speed**

THAT RADIO WAVES do not always travel with the velocity of light, as was for many years supposed, was made known recently by Dr. Harlan T. Stetson, research associate in geophysics at Harvard University at a joint meeting of the Institute of Radio Engineers and the Radio Club of America held at the American Museum of Natural History.

From a long series of day to day comparisons of international time signals exchanged between the Naval Observatory at Washington and the Royal Observatory at Greenwich, and also between this country and the Paris Observatory in France, Dr. Stetson showed how the apparent time of transmission of these radio waves across the Atlantic appeared to be influenced by some unknown cosmic causes. Some days they skip across the Atlantic on scheduled time, traveling approximately with the velocity of light, which would take the waves seven times around the earth in a second. Other days for some yet unexplained reason they doddle along at a mere 90,000 miles per second consuming twice as long as they should in their transatlantic trip. Investigations have also revealed that radio waves are most temperamental in their behavior when sent on missions to various parts of the globe. Careful comparisons of times consumed by these ethereal messengers, which are utilized by astronomers in comparing time signals in a longitude campaign, appear to in-

**1937  
NEW**

**REMLER**

Standard  
**ATTENUATORS**

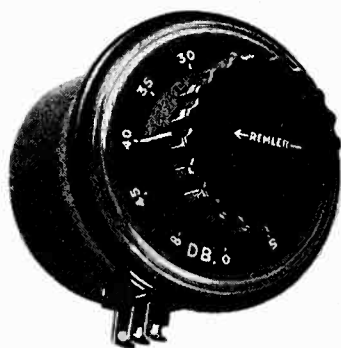
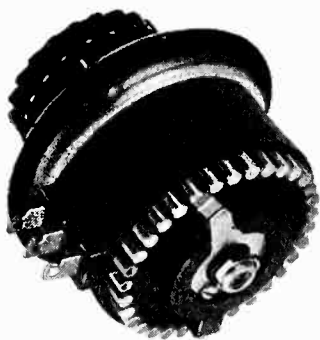

- Ball Bearing Rotor Shaft.
- Clock Spring Pigtail Connections.

**New Improvements • Same Low Price**

Improvements provide unequalled ease of operation and long life. Attenuation variable in 27 steps of 1 2/3 db. per step up to 45 db., fading in 3 additional increasing steps from 45 db. to infinity. Attenuation change halved as switch arm spans adjacent contacts resulting in attenuation of 5/6 db. per step. Impedance prac-

tically constant over entire range of the pad. Standard Impedances of 50, 200, 250 and 500 ohms. Special values to order. DeLuxe model DLA with standard sterling silver contact LA-5 Ladder Type—Net nated spring contact arm at Net . . . . . \$12.80 **10.80**

REMLER COMPANY, Ltd., 2101 Bryant St., San Francisco

**REMLER—THE RADIO FIRM AS OLD AS RADIO**



FROM

# TRANSMITTER

TO

# *Antenna*

## A Complete Installation with ISOLANTITE COAXIAL TRANSMISSION LINE

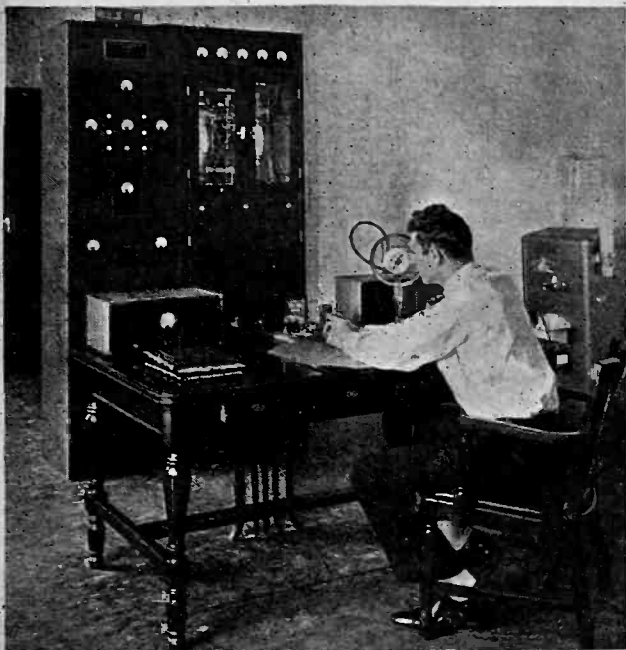

WESTERN ELECTRIC ultra high frequency Police Radio Transmitter, Station W2XEM, Newark, N. J.

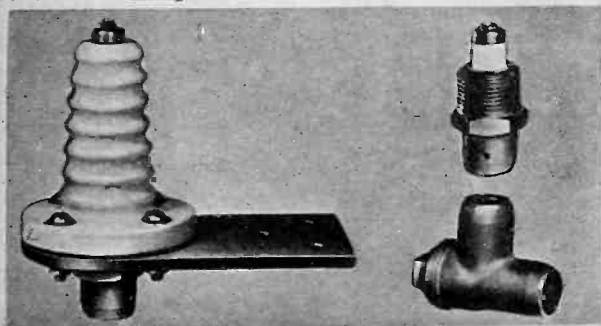

National Newark and Essex Bank Building, Showing location of transmitter and antenna connected by ISOLANTITE COAXIAL TRANSMISSION LINE.

In the rapidly developing technique of radio communication engineers recognize the coaxial transmission line as the most efficient means of conducting radio frequency energy from point to point and from transmitter to antenna.

ISOLANTITE INC. has been closely identified with this development and now announces A COMPLETE COAXIAL TRANSMISSION LINE SYSTEM for ultra high frequency and broadcasting stations.

Write for our complete bulletin on this product. ISOLANTITE INC., 233 Broadway, N. Y. C. Factory at Belleville, N. J.

Sold only through Graybar Electric Company and Manufacturers of transmitting equipment

# Isolantite

## CERAMIC INSULATORS

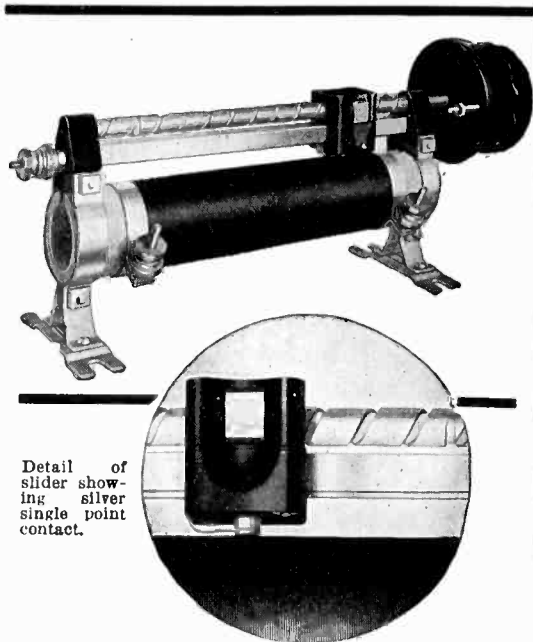

Detail of slider showing silver single point contact.

## CONTROL to the *N<sup>th</sup>* degree

With the new silver single point contact and the micro drive, notched handle

Ward Leonard Sliding Contact Tubular Rheostats are precision instruments designed for the accurate control of currents up to twenty-five amperes and voltages within their ratings. The new contact with silver single point assures positive conductivity between the slider bar and



Right angle type micrometer drive.



Vertical type, single slider adjustment.

the resistance winding. They include Rheostats in a wide range of resistance values single and dual slider adjustment types, also micrometer drive. All are arranged for potentiometer connections.

Bulletin 8001 tells the control story. Just clip this coupon to your letter-head and mail it to us.

## WARD LEONARD

RELAYS • RESISTORS • RHEOSTATS

WARD LEONARD ELECTRIC CO.  
32 South Street  
Mount Vernon, N. Y.

Please send me Bulletin No. ....  
Name .....  
Firm .....  
Address .....  
City ..... State .....

indicate that they are seriously influenced by the magnetic field of the earth which varies in different regions of the globe. Near the magnetic equator the waves travel fastest. When they are sent over paths further north and near the magnetic pole they are much more reluctant about expediting their messages. Thus in the region near the equator where the earth's horizontal intensity is greatest, they travel with a velocity apparently equal to that of light or 300,000 kilometers per second. The velocity diminishes over the more northern routes and in high latitudes where they must pass near the magnetic pole a velocity of only 200,000 kilometers is indicated. The magnetic pole itself is so disliked that the waves sometimes utterly refuse to pass it.

These new facts were presented in a discussion of "Cosmic Cycles and Radio Transmission." The effect of sun-spots on radio reception during the last sun-spot cycle indicated that the next few years may present new trouble for the long distance fans in the broadcast band. That the moon also has its effect was indicated by evidence of tides in the ionosphere, that ionized region of the earth's upper atmosphere which turns back radio waves towards the earth and makes radio communication possible. Scientists are still searching for more accurate methods of predicting the sun's activity so that those engaged in communication may anticipate conditions under which radio operators will have to work. The possibility that there may be other astronomical sources which change the electrical balance of the ionosphere offers further opportunity for speculation.

## EMBOSSSED SOUND-TRACKS

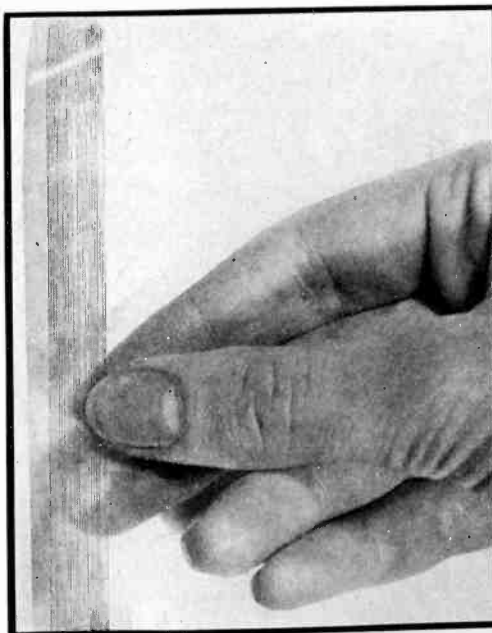

This celluloid strip has 24 separate sound-tracks embossed on its surface, which can be played back with a pick-up. A 2000 foot reel of film with 40 tracks (the limit in 16 mm. size) will give 37 hours of uninterrupted reproduction

## THORDARSON *Tru-Fidelity* FEATURES

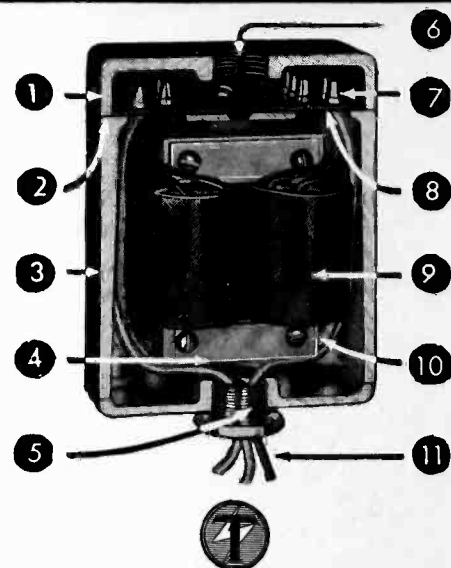

## Most Sensational New Idea in Radio

- 1 Shield Cap—No stray pickups in leads —improves appearance—permits reversible mounting.
- 2 Ground Fit—All case joints are ground fit for increased shielding efficiency against outside interference.
- 3 Case Body—Special metal, gives maximum transformer shielding and a closed magnetic circuit at all times.
- 4 Non-Magnetic Clamps—Brackets and clamps non-magnetic metal. Core and coils held in perfect symmetry.
- 5 Single Hole Mountings—Drill one hole in chassis. Pass connecting leads through bushing. Transformer rotation eliminates distortion.
- 6 Reversible Mounting—Threaded mounting hole. Fits microphone fixture—for above or sub-panel mounting.
- 7 Terminal Board—Husky mounting lugs for all connections. Terminals will not loosen when soldering.
- 8 Sub-Panel Terminals—Extra row of terminals provides connections for both primary and secondary windings.
- 9 Coils—Dual balanced coils for "hum bucking". Extended frequency range. Capacitive—inductive balance. Low leakage reactance. Distributed capacity.
- 10 Core—Special lamination. High permeability alloy of perfect uniformity. Extreme low frequency response.
- 11 Sub-Panel Leads—Pass required leads from sub-terminal board through bushing. Neat—efficient—effective.

## FREE—CATALOGS and MANUALS—FREE

Catalog No. 500 Lists Tru-Fidelity prices, curves and all specifications.  
Catalog No. 400 Complete listing of all THORDARSON radio transformers except Tru-Fidelity.  
Send today for your copy or see your parts distributor.  
6L6 amplifier with either Tru-Fidelity or standard THORDARSON transformer. See Manual SD 258.

THORDARSON ELECTRIC MFG. CO.  
500 W. HURON ST., CHICAGO, ILL.  
*Demand "Power by Thordarson"*



## FEATURES

**VOLTAGE RANGE:** 0.1 to 150 volts in 5 steps

**FREQUENCY RANGE:** 20 cycles to 100 megacycles

**ACCURACY:**  $\pm 2\%$  of full scale

**FREQUENCY ERRORS:** less than 1% between 20 cycles and 50 Mc; only 3% at 100 Mc

**INPUT IMPEDANCE:** 5 megohms at low frequencies

**INPUT TERMINAL CAPACITANCE:** 8  $\mu\text{f}$

**POWER SUPPLY:** 100 to 130 volts; 60, 50 or 42 cycles

**TYPE 726-A VACUUM-TUBE VOLTMETER:** \$165.00

Write For  
Circular 48-E  
For Descriptive  
Literature

## A RADICALLY NEW VACUUM-TUBE VOLTMETER

**Wide Frequency and Voltage Ranges • High Accuracy • Small Frequency Error**

**T**HE new General Radio Type 726-A Vacuum-Tube Voltmeter has been designed to eliminate all of the faults which have limited the usefulness of thermionic voltmeters in the past.

This new a-c operated voltmeter is equipped with a small, bakelite-housed probe containing the entire a-c measuring circuit. The cable and indicating circuit carry direct current only. All effects of long leads are eliminated. The remarkably good frequency characteristic and range are a result of this unique design feature.

The instrument requires no d-c path, and is insensitive to dc. If both dc and ac are present in a circuit, the voltmeter selects only the ac, with no appreciable error.

A new type of voltage regulator is incorporated so that annoying zero shifts are eliminated entirely. Constant zero reading is assured.

The meter scale, with an effective length of 14 inches, is essentially linear. The calibration is independent of tube characteristics to such an extent that tubes can be replaced without requiring recalibration.

This voltmeter is supplied for either 60, 50 or 42 cycle line voltage. It is equipped with line cord, pilot lamp, 6-foot probe cord and all tubes. Complete and ready for operation it is priced at \$165.00.



**GENERAL RADIO COMPANY**  
30 State Street Cambridge, Massachusetts

We Make  
**STRONG CLAIMS**  
for the "MONITOR"  
—but we can Prove Them!

We have made some sensational claims for the improved sound quality and the doubled efficiency of the Lansing Linear Monitoring System—and we are prepared to back them all with convincing proof.

The Lansing "Monitor" actually *does* give the listener a previously undreamed of conception of what sound reproduction *can* be.

It *does* double the usual efficiencies and shows a remarkably smooth response curve.

Built to provide a strikingly superior smaller unit for program monitoring and high quality speech reinforcement, it closely follows the proven performance characteristics of the larger Lansing-Shearer theater system.

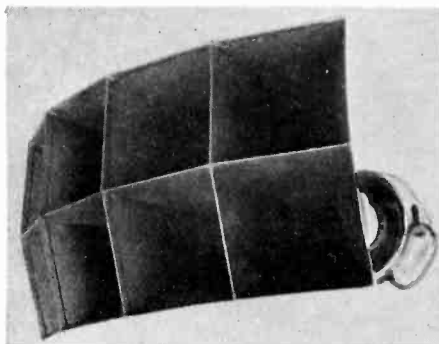

*Eight-cell exponential horn and Lansing No. 284 moving coil type speaker unit for frequencies from 300 to 8000 c.p.s. as used in the high frequency section of the "MONITOR".*

Further information on specific application will be supplied to those indicating their needs. This system is now being used with exceptional results in de luxe radio installations, small projection rooms and for station monitoring.

**LANSING MANUFACTURING COMPANY**

6900 McKinley Ave., LOS ANGELES, CALIF.

*The Famous Testing Pair*

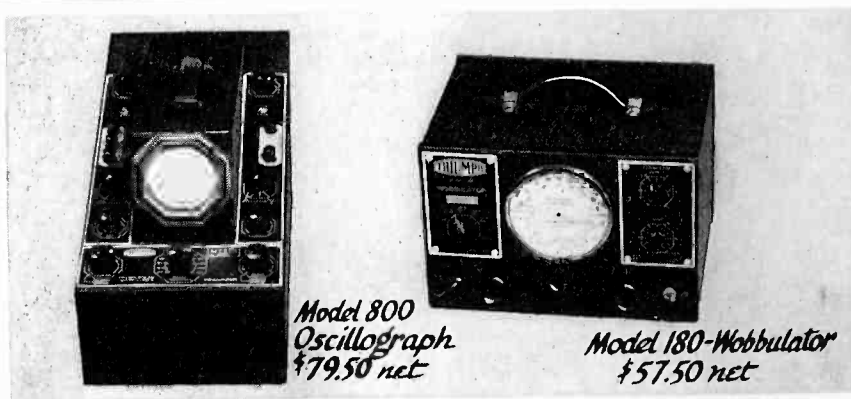

*Model 800  
Oscillograph  
\$79.50 net*

*Model 180-Wobbulator  
\$57.50 net*



The Model 180 Wobbulator and Model 800 Oscillograph today set the pace in style, design, price and popularity. The Oscillograph is a Triumph of modern engineering. "Top-operated", "Top-scanned" the perfect locking oscillograph. All unnecessary dead weight eliminated in construction. Rugged, truly portable, electromagnetically and electrostatically shielded.

The 180 Wobbulator is accurately calibrated and all adjustments carefully locked and sealed to eliminate variations from temperature change or vibrations. The first electronically driven Wobbulator.

These fine instruments are made by Triumph—builders of the world's most complete line of testing equipment. Write now for complete information. Foreign orders carefully filled.

**TRIUMPH MANUFACTURING COMPANY**  
4017 W. LAKE STREET CHICAGO, ILLINOIS

**English Translations of  
German Books on  
Short-wave Therapy**

FOR SOME TIME only available in the German version, two recent books on the production and use of short-waves are now available in English. They are:

"Short-Wave Therapy." By Dr. Erwin Schliephake. Authorized English translation by Dr. R. King Brown from the second and enlarged German edition. (238 pp.) London: The Actimic Press Ltd. 1935. 21 sh.

"Foundations of Short-Wave Therapy."

"Physics and Technics" by Dr. Wolfgang Holzer.

"Medical Applications" by Dr. Eugen Weissenberg, translated by Justina Wilson and Charles M. Dowse (228 pp.) London: Hutchinson's Scientific and Technical Publications, 1935. 12 sh. 6 d.

Schliephake's book deals mainly with the application of high frequency electrical oscillations to the treatment of disease. The second book devotes much space to a description of the methods of producing electrical oscillations of very high frequency and the heating effects they produce.

**FLAT-END TELEVISION  
TUBE**

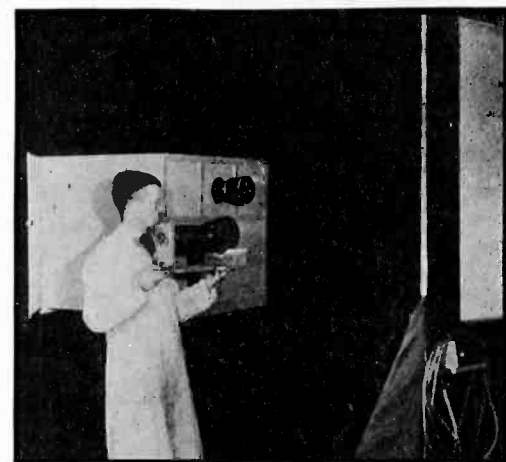

*A new type of tube with optically flat external screen surface developed in Germany. Special design prevents cave-in due to external air pressure. Distortion of the image is much reduced*

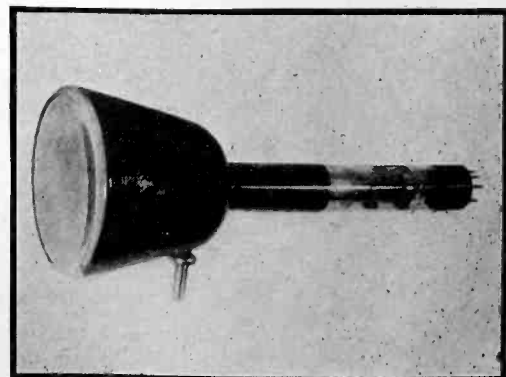

*The flat-end tube used with an accelerating potential of 20,000 volts produces bright images for projection on a 3 by 4 ft. screen.*

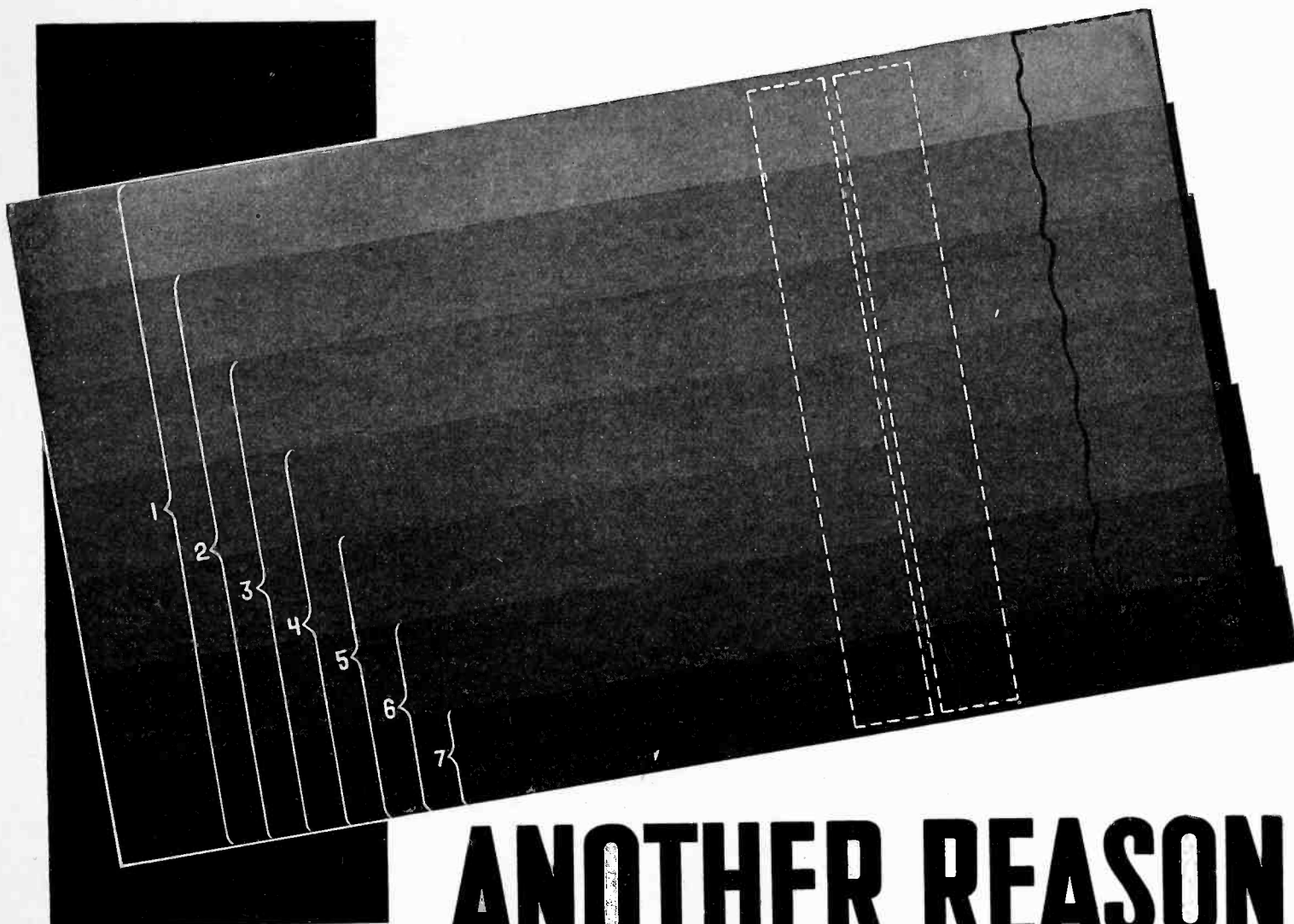

### TAPERING VOLUME CONTROL RESISTORS WITH UNIFORMITY

Volume control resistors must be tapered by applying successive coatings of conducting material since the resistances required are commonly too high to permit adequate tapering by varying the shape.

Radiohm resistors, because they are long and straight when outside the case, may have all the coats desired uniformly applied in long strips.

Brackets illustrate the approximate position of successive coatings for a logarithmic taper.

Dotted lines illustrate the individual resistors when blanked out of the strips.

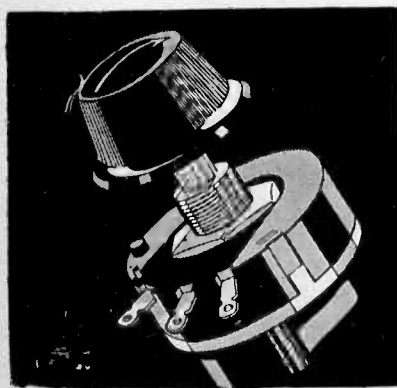

# ANOTHER REASON FOR *Centralab* SUPERIORITY

The long straight Radiohm resistor coiled on the inner circumference of the case uniformly maintains better tapers than are possible with the usual horseshoe types.

For original equipment or replacements specify CENTRALAB CONTROLS.

CENTRALAB, Division of Globe Union Mfg. Co., Milwaukee, Wis.

# Centralab

BRITISH CENTRALAB, Ltd., Canterbury Rd., Kilburn, LONDON N. W. 6, ENGLAND

CENTRALAB, 48-70 Rue Amelot, PARIS, FRANCE

# ANNOUNCING

for the first time on the American Market

a

## HIGH SPEED LEVEL RECORDER

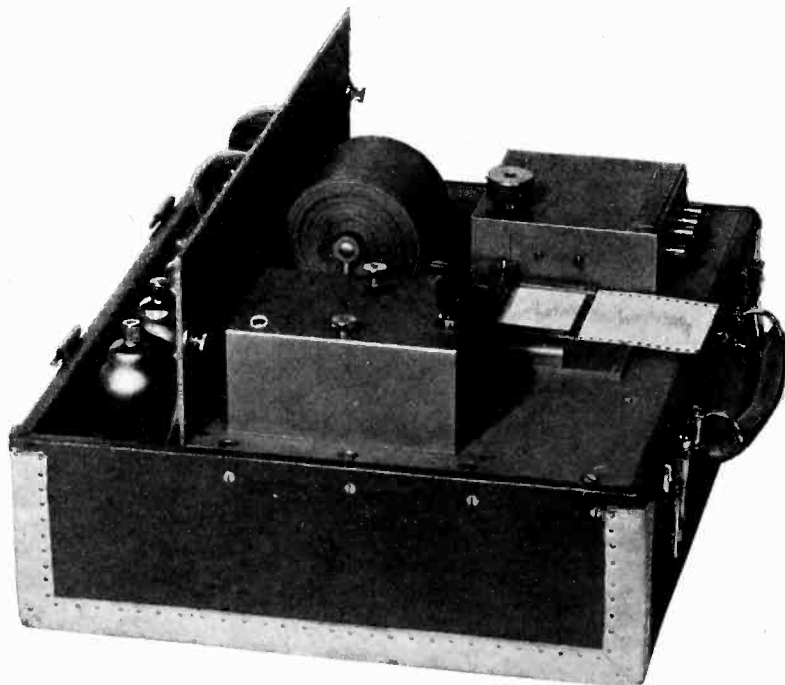

### NEUMANN HIGH SPEED AUTOMATIC POWER LEVEL RECORDER

This automatic power level recorder covers a wide range of intensities, has a recording speed of 560 DB/sec, inscribes a permanent record on paper, is calibrated on a DB scale.

Interchangeable potentiometer for power level measurements are available having range of:

0-25 DB in  $\frac{1}{4}$  DB steps

0-50 DB in  $\frac{1}{2}$  DB steps

0-75 DB in  $\frac{3}{4}$  DB steps

For measuring sound intensities a potentiometer calibrated in phones is provided having a range of 30-105 phones.

It is built in a portable form, weight 35 lbs., and is completely AC operated. It will prove a great time saver in making many important measurements as:

1. Measurement of reverberation time of studios, theaters, etc., and of sound absorbing properties of acoustic materials.
2. Routine measurements of microphones produced by mass production methods.
3. Routine sampling measurements of loud speakers in factories.
4. Measuring characteristics of high quality sound systems in the rooms where they are to be used.
5. Measuring characteristics of recording and reproducing heads.
6. Measuring transmission characteristic of audio frequency filters, transformers, equalizers, amplifiers, etc.

Write for descriptive literature.

## SOUND APPARATUS COMPANY

150 WEST 46th ST., NEW YORK, N. Y.

Sole Distributor of

Neumann sound recording apparatus  
Saja Synchronous Motors

Herold cutting and reproducing needles  
Duralotone records

### Modulation Monitoring

[E. DIVOIRE, Assistant Director, Control Laboratory, International Broadcasting Union (V.I.R.) Brussels.] It is well known that sounds differ too much in strength to be faithfully recorded by simple instruments. The vibrations produced in the air by a big drum may reach amplitudes equal to 0.1 per cent of atmospheric pressure; the faintest sound from a violin gives an amplitude not exceeding 0.5 millibar (or about one thousand millionth atmospheric pressure) at a distance of 1 m. from the instrument. In one and the same piece of music the variations are narrower, seldom as 3000:1 or 70 db., more often 300:1 (50 db.), or 100:1 (or 40 db.). Transmitting amplifiers are, therefore, built for the narrower ranges, excess leading not only to distortion, but also owing to the presence of higher harmonics and overlapping with the neighboring

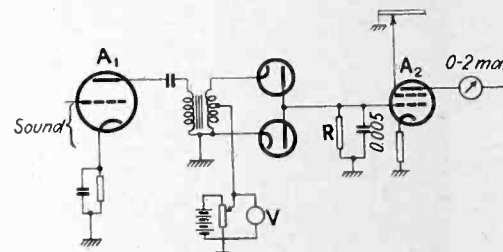

Double-rectifier modulation level indicator

channels (monkey chatter). Programs remaining below the average level, on the other hand, mean a waste of the carrier power. It is therefore necessary to control the upper and lower a-f amplitudes and with them the limits of modulation.

An instrument for checking the a-f amplitudes must read over a range of 100:1 with an accuracy of about 10 per cent, the scale being preferably logarithmic so as to conform with the ear. Since sounds lasting less than 0.1 sec. do not produce their full effect on the ear, the meter should give correct readings for sounds lasting 0.2 sec. and be independent of the frequency between 30 cycles and 10,000 cycles per second.

An expedient adopted for some time was to use an ordinary galvanometer which had been calibrated with steady potentials and to apply to the readings corrections depending on the nature of the music played (chamber music, symphony dance music, speech). The laboratory of the International Broadcasting Union (V.I.R.) at Brussels undertook to establish correction factors with the aid of an oscillograph. The solution adopted later was a combination of a diode, a delay circuit and a micro- or milliammeter with low inertia.

An average moving coil galvanometer indicates short pulses faithfully if they remain constant for about 0.2 sec. Impulses lasting only 0.01 sec. register with a fraction of their amplitude. By decreasing the mass and by

from Toasters to Motor Cars..

# SHAKEPROOF

**NEW tapered-twisted teeth**  
**GIVING SENSATIONAL LOCKING RESULTS!**

AMERICAN INDUSTRY has definitely proved the outstanding superiority of Shakeproof Lock Washers. On practically every leading metal product you will find their new tapered-twisted teeth holding connections tight and providing positive protection against the damaging action of vibration. This powerful holding method provides a combination of three important locking factors that no other lock washer can duplicate. It includes sturdy strut-action, powerful spring-tension, and a substantial line-bite at initial contact.

**Test SHAKEPROOF on your own product!**

Don't be fooled on lock washers values—determine by your own tests on your own product how you can secure the greatest performance protection. Shakeproof Lock Washers never let go—in fact, the greater the vibration the tighter they hold. Each tapered-twisted tooth bites into both nut and

work surfaces, setting up a powerful leverage that positively resists any backward movement of the nut. And, besides, the exclusive shape of each tooth provides a strong spring-tension because the greater width at the root enables the body of the lock washer to resiliently cooperate with the twist of the tooth in maintaining an efficient line-bite. Send today for your free test ring of Shakeproof Lock Washers—you'll quickly appreciate their ability to hold any nut or screw absolutely tight! Mail the coupon below, today!

## SHAKEPROOF LOCK WASHER CO.

Distributor of Shakeproof Products Manufactured by Illinois Tool Works  
 Chicago, Illinois  
 2501 North Keeler Avenue



EXTERNAL TYPE



INTERNAL TYPE

FREE TEST RING!



U. S. Patent Nos. 1,862,486—1,909,476—1,419,564—1,604,122—1,909,477  
 1,782,387—1,963,800. Other Patents. Patents Pending. Foreign Patents.

SHAKEPROOF LOCK WASHER CO.  
 2539 North Keeler Ave., Chicago, Illinois

Gentlemen: Send me FREE Test Ring of Shakeproof Lock Washers by return mail so that we may judge their locking power on our own products.

Name.....  
 Firm Name.....  
 Address.....  
 City..... State.....

*Mail Today!*

# BRUSH *General Purpose* MICROPHONE

● The Brush G2S2P sound cell microphone—an all around general purpose microphone for program—remote pickup and announcing work. Widely used in high grade public address installations. A typical sound cell microphone built to Brush's traditionally high mechanical and electrical standards. Non-directional. No diaphragms. No distortion from close speaking. Trouble-free operation. No button current or input transformer to cause hum.

Beautifully finished in dull chromium. Output level minus 70 D. B. Size 3 inches by  $1\frac{3}{4}$  x  $1\frac{1}{8}$  inches. Furnished complete, with a Brush S-1 Socket that facilitates easy installation. Full details, Data Sheet No. 4. Free. Send for one.



# BRUSH *Headphones*

● Meet every headphone requirement. Response 60 to 10,000 cycles. No magnets to cause diaphragm chatter. Specially designed cases minimize breakage. Light in weight. Only 6 oz., complete with headband and cords. A quality product at a low price. Details, Data Sheet No. 10. Copies on request. Send for one.

The

# BRUSH

DEVELOPMENT  
COMPANY

1884 E. 40th St.

PIEZO  
ELECTRIC

CLEVELAND, O.

MICROPHONES • MIKE STANDS • TWEETERS • HEAD PHONES • LOUD SPEAKERS

*Specify these leading...*

## CALLITE PRODUCTS

For "Quality Insurance" At No Extra Cost!

### ● TUNGSTEN

Rod, Sheet, Wire, and Special Shapes

### ● MOLYBDENUM

Rod, Sheet, Wire, and Special Shapes

### ● KULGRID WIRE

Kulgrid "C" Tungsten Welds  
Kulgrid "C" for Grid Side Rods  
Kulgrid "S" Grid Wire

### ● CONTACTS

For all applications:—Tungsten & Molybdenum—  
Silver and Platinum—Precious Metal Laminated  
Contacts—Silver and Platinum on base metals

### ● "CALLIFLEX"

#### THERMOSTATIC BIMETAL

Types Available:—High Temperature—Medium  
Temperature—Low Temperature—Rust  
Resisting

### ● TUNGSTEN & MOLYBDENUM ALLOYS

High Conductivity Facing Material for:—  
Welding Electrodes—Controlling Devices—Circuit  
Breakers—Heavy Duty Relays—High Current  
Density Contacts

### ● CAL-LUX FLUORESCENT MATERIALS

with Measured Characteristics for All  
Applications

*Let Us Quote On Your Requirements!*

Each of these Callite Products is a pacemaker for reliable quality, dependable performance, and attractive price. Select the items in which you are most interested and . . . WRITE FOR INFORMATION

## CALLITE PRODUCTS DIVISION

EISLER ELECTRIC CORPORATION

544-39th STREET

UNION CITY, N. J.

increasing the strength of the magnetic field the instrument may be made to indicate pulses of about 0.025 sec. duration with practically full strength (length of complete scale 200 mm., power consumption 1.5 milliwatt, moment of momentum 300 mgr. cm.). Since the return to the zero position takes about the same time, the eye is hardly in a position to follow the movements, hence the need for slowing down the return swing if manual control is desired. The necessary delay is obtained by means of a circuit having the resistance  $R$  and the condenser  $C$  in parallel in the plate lead of the diode to which the audio frequency is applied. It is known (see *Wireless Engineer* for January 1935) that under these conditions the voltage developed between filament and plate increases with time, and is practically proportional to the input voltage when  $Rr$  exceeds 100,  $r$  being the internal resistance of the diode. The internal resistance  $r$  is rendered small by using a double diode in push pull. In order

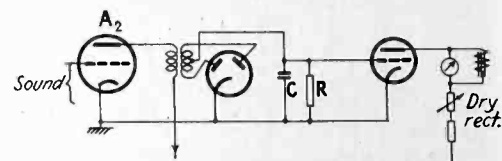

CR time constant circuit

to make the response independent of the frequency  $f$ , the product  $RCf$  must be kept small in order to reduce the time for charging (a few thousandths of a microfarad),  $R$  must be made large between 20 and 100 megohms, which may unduly increase the time required for the discharge. The value desired is about 0.5 sec.

One improvement in this respect is to reverse the direction in which the rectified audio voltage is applied to the grid of the amplifying tube following the diode so that in the course of the discharge the grid becomes more positive. With  $R$  equal to 100 meg. charging takes 0.001 sec., discharging 3 sec., with 35 meg. the corresponding figures are 0.001 and 1 sec., with 16 meg.  $\$.1$  sec. and 0.5 sec., these latter values being quite satisfactory.

Another solution found when the load  $R$  is too high to use a second stage of amplification ahead of the diode, and a choke coil in parallel with the moving coil in order to decrease the response to signals of very short duration (Nestel and Thilo). If manufacturing tolerances applying to exponential tubes are sufficiently narrow, they may be used for getting an output current which increases as the logarithm of the input voltage.

Instead of being used in the studio, the instrument may be set up near the transmitter adding a first detector for the carrier frequency so as to allow a continuous check on the degree of modulation. *Onde el.* 15, No. 169: 40-58. 1936 W. Nestel and H. G. Thilo. *El. Tech. Z.* 57: 197-199, 1936. See also the *Gen. Rado Experimenter* for December 1935.



# SO THAT THERE MAY BE

# Progress

A view of the WOR transmitter. Designed by Bell Telephone Laboratories.

Cornell-Dubilier Mica Transmitting Capacitor Type 57 used in this installation.

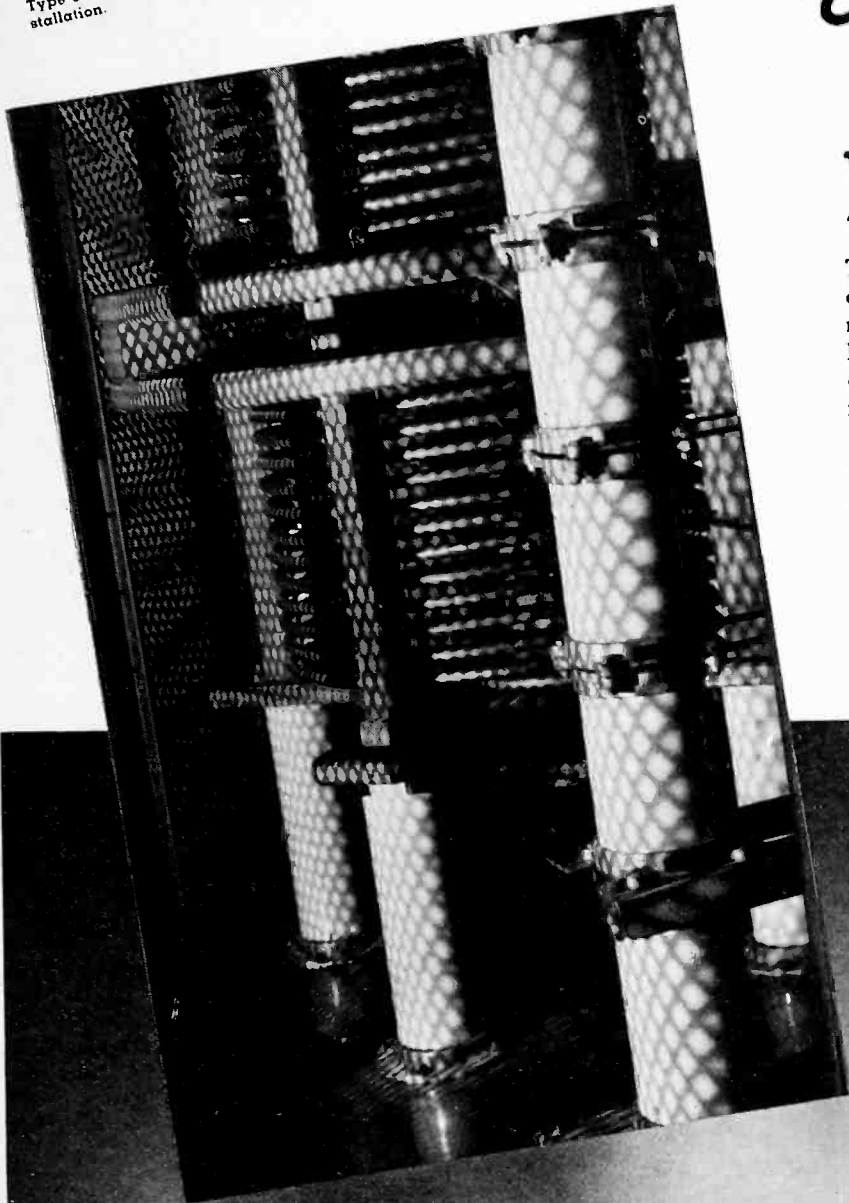

WHEN the Persians Invaded Greece, 480 B.C., a line of sentinels shouted messages from Susa to Athens—450 miles in eight hours.

The world has grown smaller, thanks to modern communications systems . . . to Marconi, who first flashed wireless messages from Ireland to Buenos Aires, to Lee deForest and Frederick A. Kolster, who worked in laboratories in the teens of this century, to William Dubilier, who helped pioneer radio-telephony. Thanks to these scientists . . . to the early efforts of the Cornell-Dubilier Corporation, today a message girdles the globe in a matter of seconds.

Today—in two modern factories which turn out the most complete line of condensers in the world—Cornell-Dubilier places at the disposal of the engineer complete facilities for forward-looking research, for quick service, so that today's best can be made even better tomorrow—so that the far spaces of the earth shall be as close as our own backyard.

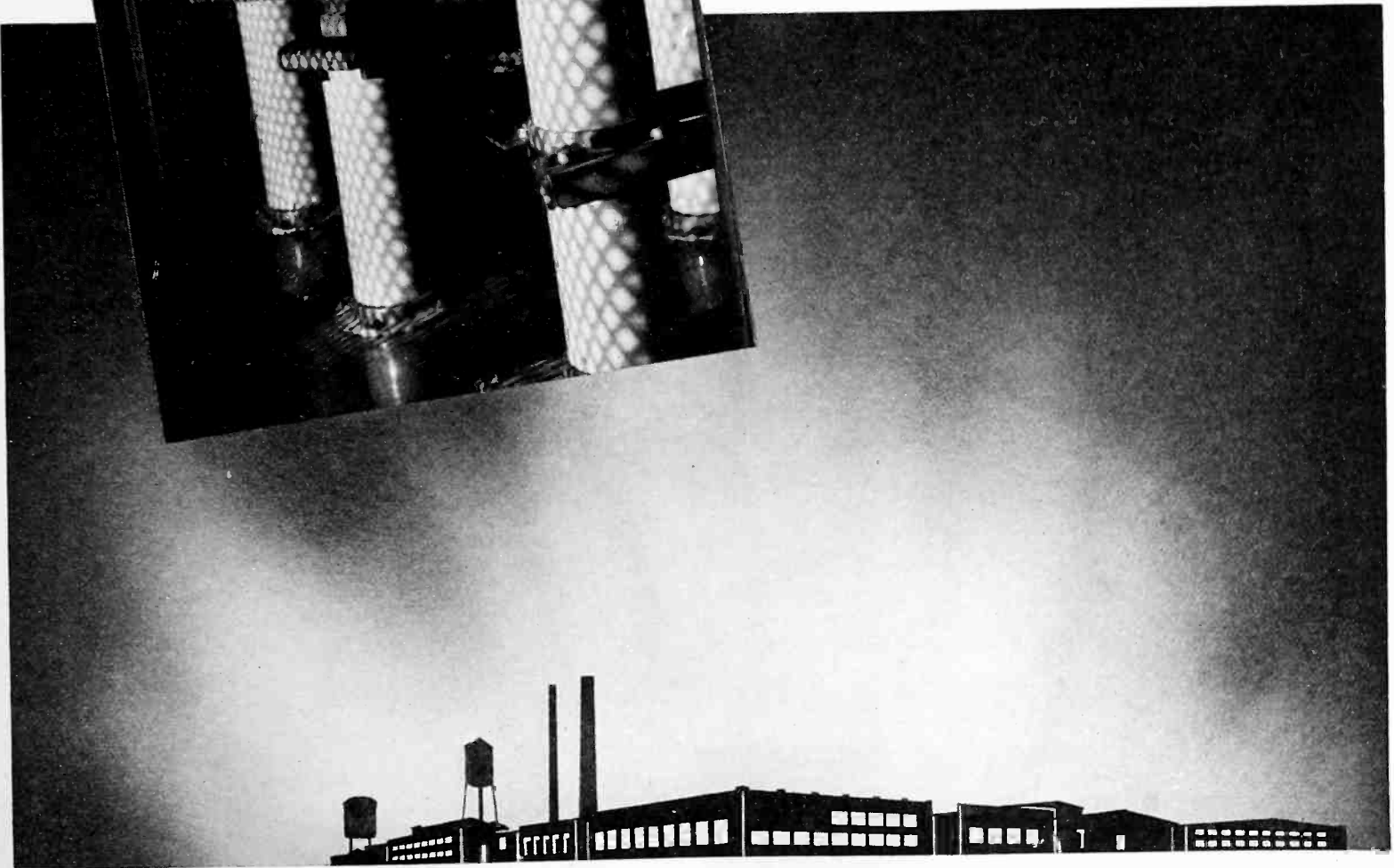

MICA • DYKANOL • WET & DRY ELECTROLYTIC • PAPER

CORNELL  DUBILIER

CORNELL DUBILIER CORPORATION  
1006 HAMILTON BLVD. • SO. PLAINFIELD, N. J.

# GOAT

## FORM FITTING TUBE SHIELDS

are used by

THE  
BELL TELEPHONE LABORATORIES

and

THE WESTERN ELECTRIC COMPANY

(Manufacturers for the BELL SYSTEM)

under specifications prepared by

THE BELL LABORATORIES

★ ★ ★ ★ ★ ★ ★



GOAT RADIO TUBE PARTS, INC.

(A Division of THE FRED GOAT CO., INC., Est. 1893)

314 Dean Street, Brooklyn, N. Y.

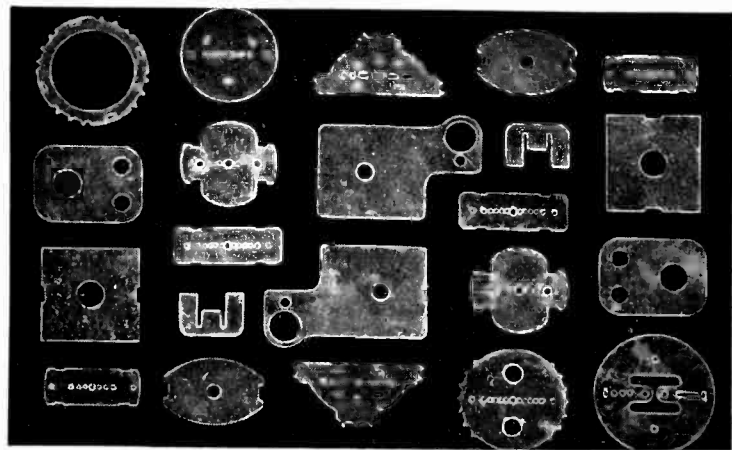

### These MICA SHAPES are noted for Accuracy

Tube and condenser manufacturers are most enthusiastic about the accurate machining of our mica shapes . . . made of the finest mica obtainable . . . Munsell's India Ruby Mica. Further details, prices

and samples gladly furnished. *Other Electrical Insulations:* more than 120, including Varnished Cloths, Bakelite Laminated and Micanite are described in our new Price List No. 101. Write for copy.

## MICA INSULATOR COMPANY

200 Varick Street, New York; 542 So. Dearborn Street, Chicago;  
1276 West Third St., Cleveland. Branches at: Birmingham, Boston,  
Cincinnati, Los Angeles, San Francisco, Seattle, Montreal, Toronto.

### Fighting Artificial Static in France

[MICHEL ADAM]. The French legislation of March 30, 1934 considers the field strength of a disturbing noise source as excessive when it interferes with the reception of a station which produces at the receiver a field strength of one millivolt per meter, and demands that measures be taken whenever the two signals differ by less than about 25 decibels, the desired signal having a degree of modulation of 30 per cent at a frequency of 800 cycles per sec. In other words, the strength of the disturber should not be more than 5 per cent of the strength of the wanted signal. Intermittent noises are considered objectionable when they last more than three seconds and occur more than once in ten minutes.

About 150 radio officers have received instruction in tracking interference. A standard superheterodyne with 5 tubes and a power tube is used. The antenna is formed by a vertical dipole consisting of two tubes of aluminum 1.5 cm. in diameter and 1 m. long. Detection and amplification are practically linear; the volume is adjusted by changing the grid bias of the r.f. and i.f. tube. The intermediate frequency is 140 kc. Variable attenuation is obtained by using a high resistance potentiometer for coupling the detector with the first a-f amplifier, the 25 decibel point being clearly marked on the dial.

A filter prevents noises from entering the receiver through the power supply; it consists of two coils of 1 mhy., with two 0.05 uf. condensers near the outlet and 0.2 uf. near the receiver. The interference is measured by means of a direct reading galvanometer and a copper oxide rectifier, the total range being 700 microamps. A calibration sheet indicates the readings on the galvanometer which correspond to the 25 db. point below the standard signal. The receiver weighs less than 12 kg.

At the present moment the legislation applies only to devices of low power, such as domestic appliances, small motors and interruptors. In the first complete month of functioning 13,465 defective devices were located, in the second month 13,632, in the third 13,577 and so on.

In Switzerland, on the contrary, particular attention has been paid to troubles caused by electric traction which have proved to be strongest at zero load. *Revue gen. El.* 39: 231-238, 1936.

### Chemical Applications of Phototubes

[J. A. WALTERS]. The various types of light-sensitive cells are described and the author points out that phototubes are not always the best solution to an industrial problem and that simpler alternatives can often be found. — *Jour. Soc. Chem. Ind.* 54:258-61, 1935.



**VARIETY** — *the Spice of Life!*

**L**IKEWISE the "spice" of CANNON Plugs—over 600 fittings (varying from 1 to 34 poles) for special purposes—thousands of stock parts always on hand . . . These make possible an almost infinite number of combinations, enabling us to supply unusual needs with unusual speed without sacrificing Quality . . . Leaders in the airplane and the sound-recording industries standardize on CANNON Cable Connectors for Safety, Service and Economy.

*Ask for your copy of General Plug Catalog or Special Airplane Plug Catalog*

**CANNON** **CABLE**  
**CONNECTORS**



**CANNON ELECTRIC DEVELOPMENT CO.**

420 WEST AVENUE 33, LOS ANGELES, CALIFORNIA

*Eastern Sales Office: 220 FIFTH AVE., NEW YORK, N. Y.*

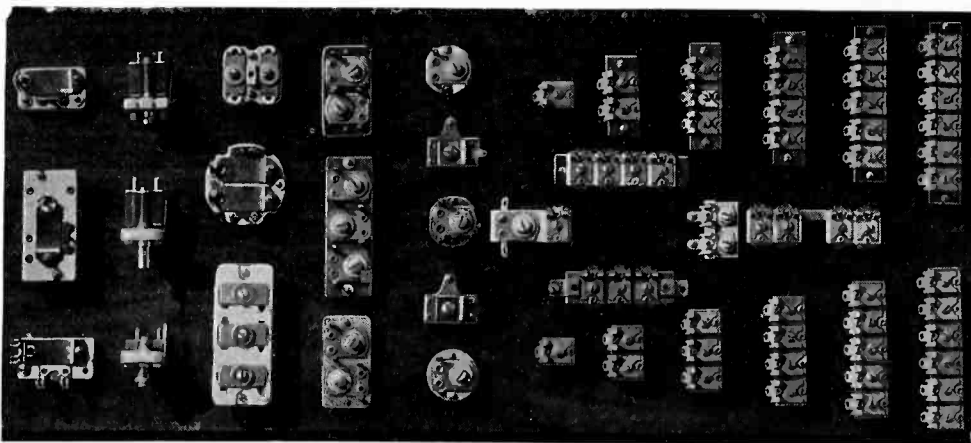

## HAMMARLUND CONDENSERS FOR EVERY PURPOSE

Twenty-five years ago, the first Hammarlund variable condensers made a heralded appearance to the applause of the communication engineering world. Their dominant superiority became a by-word in laboratories, factories, schools, and homes the world over. Today, specialists continue to show their approval of these distinctive Hammarlund items by continually specifying their use in every conceivable type of communication instrument. A few of the distinguished members of the Hammarlund family of users are Bell Telephone Labora-



tories, G.E., Westinghouse, Western Electric, R.C.A., U.S. Army and Navy, Bureau of Standards, foreign governments the world over, etc. Every feature of Hammarlund condensers is designed for peak electrical and mechanical performance. Wide capacity ratios, vibration proof construction, quality insulation, selected metals—all with an eye to dependable trouble-free, long-lasting service, characteristic of Hammarlund workmanship. Countless stock models available. Special types made to specifications.

Send for the complete interesting Hammarlund story by writing to Dept. E-10

THE HAMMARLUND MANUFACTURING COMPANY, INC.  
424-438 WEST 33rd STREET, NEW YORK CITY

**HAMMARLUND'S 25<sup>TH</sup> YEAR**

## TELEVISION? SOUND? INDUSTRIAL?



Whatever your interest may be in photo cells—there is a dependable super-sensitive CETRON available for most purposes.

As specialists in the manufacture of photo cells we are prepared to supply a wide range of standard cells or, if you prefer, we will make them to your specifications.

We invite your inquiry.

**CONTINENTAL ELECTRIC CO.**  
ST. CHARLES 7 ILLINOIS

## CLEEN-CUT

The QUALITY BLANK for Instantaneous and transcription recording is STANDARD with the foremost recording studios as well as with the largest and most discriminating users of recording blanks. *Write for literature and price list.*

*Watch for important announcement—coming soon—regarding our new sound recording equipment.*

**ALLIED RECORDING PRODUCTS CO.**

Phone BRyant 9-1435

126 West 46th Street, New York, N. Y.

## Reactors

[Continued from page 20]

greater with no d-c in the reactor is taken advantage of in the design of "swinging" chokes. These chokes are used in rectifier filters to improve the regulation. The higher the inductance of the choke, the less rise in voltage there is at light d-c loads. If, then, the choke is allowed to saturate considerably at full load, the inductance rises as the load is decreased, and the regulation is improved, without necessitating the use of a large choke having high inductance at full load. Part of the advantage is lost because saturation prevents the reactor from performing well on positive ripple peaks at full load, but the overall result is a smaller choke for the same regulation and ripple.

Besides this quality of linearity, it is of course necessary that the reactor or transformer have the proper amount of inductance. The latter can be found from Fig. 6, which represents the low frequency end of three audio response curves. Instead of having frequency for abscissas, these curves have  $X_n/R_1$ , where  $X_n$  is the reactance at low audio frequencies and  $R_1$  is the resistance of the source, such as a transmission line or vacuum tube. The remaining variable  $R_2$  is the load resistance, and the three curves are for three common relations between  $R_2$  and  $R_1$ :

$$R_2 = R_1 \text{ (line matching)}$$

$$R_2 = 2R_1 \text{ (U.P.O. load for triodes)}$$

$$R_2 = \infty \text{ (open grid load)}$$

In the case of a transformer, the load resistance  $R_2$  is referred to the primary side by the square of the transformer ratio. The ordinates are "Db" down from 1000 cycles."

A final example will serve to illustrate the use of the curves. Let a transformer be required to deliver the maximum undistorted power output of a triode having a plate resistance of 5000 ohms into a 500 ohm load, with not more than 1 db drop in response at 30 cycles.

For maximum U.P.O. the primary load resistance should be 10,000 ohms and so the turns ratio is  $\frac{10,000}{\sqrt{500}}$  or 4.46. The proper curve in Fig. 6 is  $R_2 = 2R_1$ , and for 1 db down we see that  $X_n/R_1 = 1.3$  or  $X_n = 6500$  ohms at 30 cycles. This corresponds to 34.5 henries primary inductance.

USED BY LEADING BROADCAST STATIONS

FAIRCHILD-PROCTOR

*Crystal* PICKUP

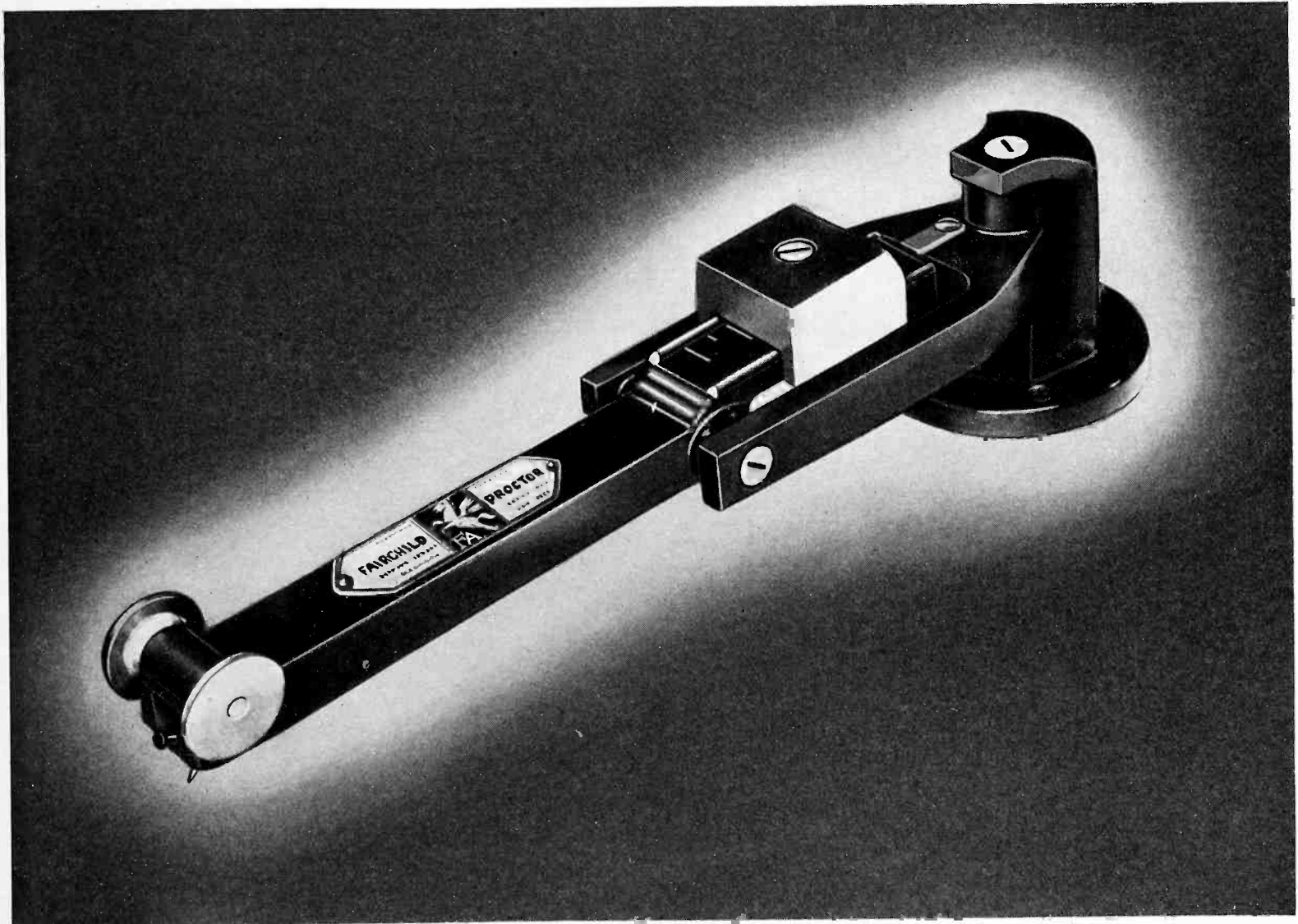

Electrically and mechanically engineered to produce the finest and most uniform response throughout the entire audio range—with minimum record wear—Fairchild-Proctor Pickups are becoming standard equipment in the foremost broadcast stations throughout the world.

Light Weight · Scientific Balance by Adjustable Counterweight; Calibrated Needle Pressure Scale · Ball-bearing throughout · Minimum Record Wear · Extended Frequency Range, High and Low · Uniform Response · Non-Resonant · Non-Magnetic · Freely Damped · Selected Crystal · Precision Manufacture.

Other Fairchild-Proctor equipment includes: Radio Station Studio Recorders — Portable Recorders — "Word-Spotters" for Sound Effects — Pre-Setting Pickup — Transcription Turntables. Write for complete Catalogue, addressing Dept. E-2.



FAIRCHILD AERIAL CAMERA CORPORATION

SOUND EQUIPMENT DIVISION · 62-10 WOODSIDE AVENUE, WOODSIDE, NEW YORK CITY

ELECTRONICS — September 1936

77

Let **CLAROSTAT**  
Solve  
YOUR RESISTANCE PROBLEM

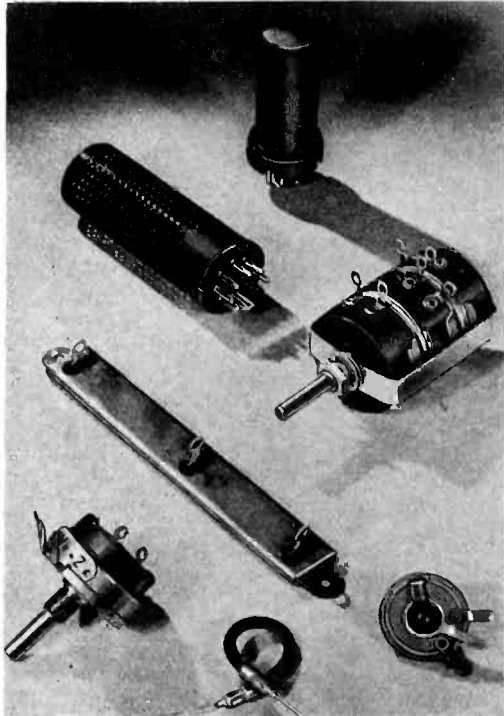

The resistance art is the job of a specialist, and CLAROSTAT specializes in just that alone. We welcome your problems. Our engineers gladly cooperate. Meanwhile, our plant can supply any of these resistance devices . . . .

★ **FIXED:** Inexpensive wire-wound flexible resistors. Wire-wound strips—bare, metal-clad, or molded. Precision units to 1% or less tolerance. Wire-wound plug-in and metal tube type units.

★ **ADJUSTABLE:** Potentiometers, rheostats, volume controls—single, dual, triple—for T-pad, mixer, L-pad constant-impedance control. Handy "humdinger" potentiometers.

★ **BALLAST:** Automatic resistors to correct line voltage and other fluctuations. Any style male and female terminals.

Send for DATA . . .

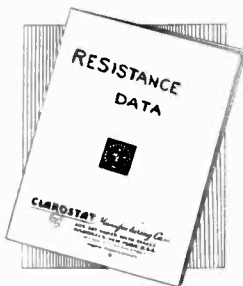

NEW loose-leaf engineering information on all types of resistors.

Do not hesitate to submit your engineering problems for aid and quotations. CLAROSTAT products are bought by such critical users as W. E., Bell Labs., leading networks, etc.

**CLAROSTAT**  
MANUFACTURING CO.  
Incorporated  
285 North Sixth St.  
Brooklyn, N. Y.

Visit with us at Booth 25, I.R.S.M. Show

# MANUFACTURING REVIEW

## News

♦ **Globar Corporation** announces the change of their name to The Carborundum Company, Globar Division, Niagara Falls, New York. The Carborundum Company has purchased the complete assets of the former Globar Corporation and from now on the company will function as one of the definite divisions of The Carborundum Company.

♦ **Transformer Corporation of America** announces the opening of a new and modern plant at 69 Wooster Street, New York City, for the manufacture of radio and allied products under their Clarion trademark. This company has recently been reorganized and new officers are Hubert Shortt, president and general manager, and Frederick H. Skortzki, treasurer and sales manager.

♦ **Norwalk Engineering Corporation**, South Norwalk, Connecticut, announces their entry into the business of manufacturing coils for radio set manufacturers. This company, organized in March, 1936, is now ready to supply manufacturers with r-f, i-f or other types of windings. The members of the firm are Edwin A. Gelein, President and Treasurer (University of Wisconsin, 1915), Kenneth W. Jarvis, Vice President and Secretary (Ohio State, 1923), Russel M. Blair, Chief Engineer (University of Cincinnati, 1926), and James Hobusch, Production Superintendent.

Mr. Jarvis and Mr. Blair are well known in radio engineering circles (Crosley, Zenith and Meissner), Mr. Hobusch was production superintendent with P. R. Mallory and Meissner, and Mr. Gelein was Vice-President and member of the board of Warren-Nash Motors Corp. of New York, 1920-1935.

♦ **Zophar Mills, Inc.**, have moved to new headquarters at 112-130 26th Street, Brooklyn, New York, where they will continue to manufacture electrical insulating compounds, textile saturators and similar products. They also announce the opening of a Chicago office at 21 E. VanBuren Street.

♦ **Kay Products of America** announce their removal to new and larger quarters at 39-01 Queens Boulevard, Long Island City, New York.

♦ **Webster Electric Company**, Racine, Wisconsin, announces that it now offers to the trade a full line of Sound systems licensed under patents owned or controlled by Western Electric Company, Inc., and the American Telephone & Telegraph Company.

♦ **American Lava Corporation**, Chattanooga, Tennessee, has opened its new plant, with research laboratory and three times the capacity of the old plant, accomplishing the move without interruption of production.

## New Products

### Multi-tester

**RADIO CITY PRODUCTS COMPANY**, Park Place, New York City, has developed a testing instrument which serves as forty-one different instruments, measuring resistance, capacity, a-c and d-c voltages and current, power level in d-b and inductance. It lists at \$31.50 and is known as Model 4N.

booster provides a continuous flow of current at a constant level for unlimited periods of time.

### Deaf Aid

**THE SONOTONE CORPORATION**, manufacturer of hearing aids, has recently redesigned its Sonotone Power Booster, employing a housing of gleaming black Bakelite molded. This attractive, compact amplifying unit can be plugged into any electrical outlet, thereby eliminating the use of batteries. The power



**QUALITY  
ABOVE ALL!**



**SOLAR**

New "Standard" Dry Electrolytics offer large price- and space-savings over previous types. These modern Solar condensers include a wealth of experience combined with the lessons of yesterday and the needs of tomorrow. Literature on request.

WET AND DRY ELECTROLYTICS . . . . . PAPER, MICA, TRIMMER CONDENSERS

**SOLAR MANUFACTURING CORP.**

**599-601 Broadway**

**New York City**

MANUFACTURING AFFILIATES IN LONDON · PARIS · BERLIN · MILAN

[www.americanradiohistory.com](http://www.americanradiohistory.com)

**RELIABLE IN  
EVERY CLIMATE  
CONDENSERS**

# LEADING 1937 DESIGNS

## Specify

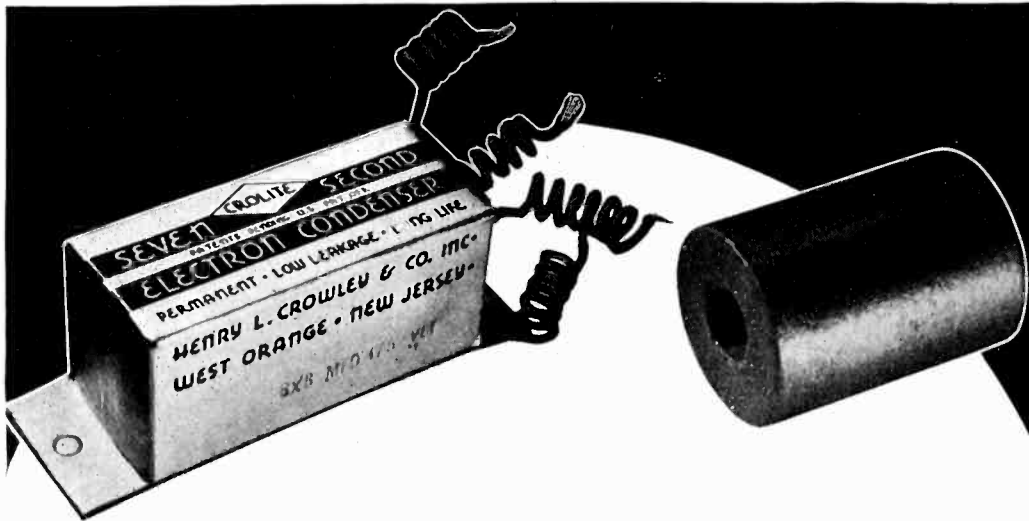

### CONDENSERS

New permanent, stable electrolyte principle. Will withstand tremendous overload. Full Test report available.

### MAGICORES

New designs give as high as 6 to 1 gain in  $Q$  and  $L$ . Today's latest and most advanced developments in receiver design. See special report and samples.

PATENTED

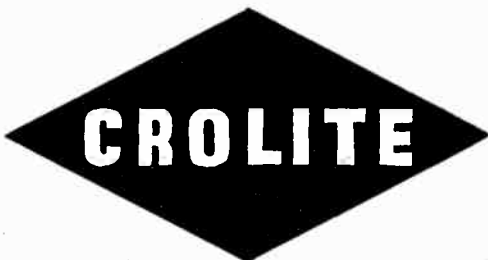

PROCESS

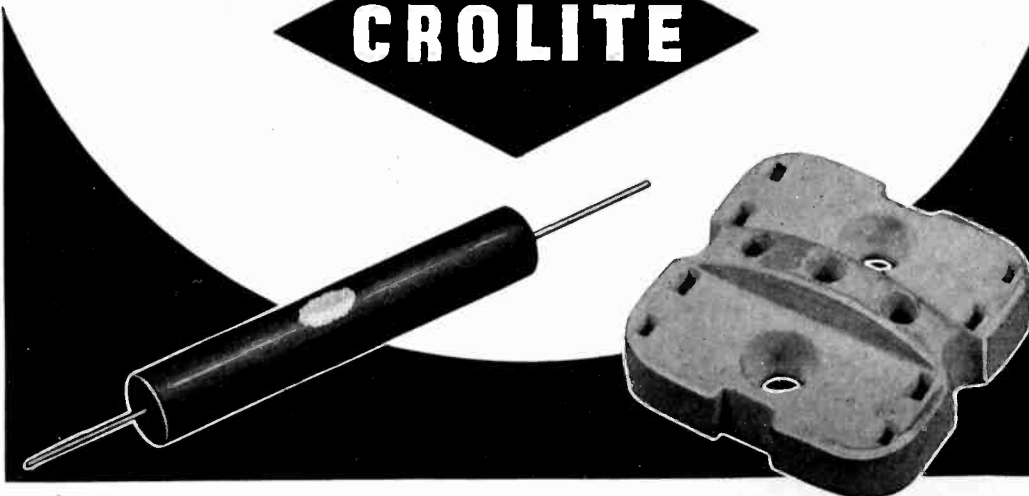

### RESISTORS

Noiseless even in meggers.

### CERAMICS

The original low loss ceramics. New developments: high dielectric constant; low, thermal expansion; and other special ceramics. Bulletins available.

SAMPLES ON REQUEST

**HENRY L. CROWLEY CO., Inc.**  
1 CENTRAL AVE., WEST ORANGE, N. J.

CONDENSERS • MAGICORES • RESISTORS • CERAMICS

### AC/DC Circuit Tester

FERRANTY ELECTRIC, INC., 30 Rockefeller Plaza, New York, N. Y., announce a new AC/DC Circuit Tester for the communications field. Weighing 14 oz. it can be carried in the pocket. AC voltage, DC voltage, AC mils, DC mils, and ohms can be measured. It is contained in a polished black bakelite case and has a scale length of 2½", and a knife edge pointer giving accurate readings. There are

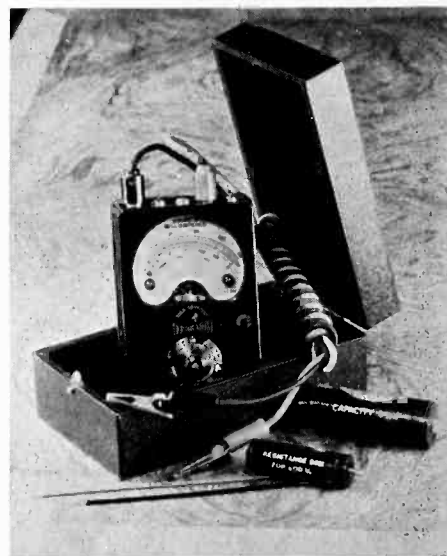

five AC voltage scales: 0-15, 0-150, 0-300, 0-450 and 0-600 volts. Six DC voltage ranges are: 0-3, 0-15, 0-150, 0-300, 0-450 and 0-600 volts. The AC range is 0-1 mil, and the DC ranges are: 0-1, 0-7.5, 0-30, 0-150, and 0-750 ma. Resistance ranges are 0-50,000, 0-150,000, 0-750,000 ohms, and 0-7.5, 0-15, 0-30 megohms.

A clearly marked rotary switch is fitted at the front for range selection making the instrument extremely simple to operate. The terminals of the instrument are of the socket type clearly marked and located at the top of the case. Connection to these terminals is made by means of a pair of leads fitted with substantial plugs at one end and crocodile clips at the other. The crocodile clips are removable and can be replaced by insulated test prods as required.

### Colorimeter

A CALIBRATED, direct-reading, photoelectric photometer known as the Kuder Colorimeter is being marketed by Fisher Scientific Company of Pittsburgh, Pennsylvania. There are two models, one having nine scales, the other having a linear scale with a six-step sensitivity control. It uses a barrier layer cell and provides the direct accurate method of reading the concentration of colored solution. It has a photometric accuracy of ½ of 1%. The two models sell for \$450 and \$400 respectively.



# Without investing a Dollar!

## ...7 out of 10 can Modernize metal and plastic Assemblies

—to win economies and benefits like these

**M**ODERNIZATION usually implies an investment in equipment or costly changes in method. But in one of the most important plant functions . . . *Assembly Work* . . . it can be carried out with profit by 7 out of 10 concerns that assemble metal or plastics, *without investing a dollar.*

Proof of this is found in the results obtained by hundreds of plants. In 7 out of 10 cases where Parker-Kalon Assembly Engineers have been invited to investigate opportunities for applying Hardened Self-tapping Screws, assembly work has been improved without expense or radical change. Fastening jobs were speeded-up, made easier and cheaper . . . assemblies were strengthened . . . new possibilities for design simplification and product improvement were opened-up, merely by substituting Hardened Self-tapping Screws for more complicated and costly methods.

Plants that know and make some use of these famous Screws often benefit most from a serious attempt to utilize them to the fullest practicable extent for simplifying assembly work and reducing costs. In studying fastening jobs with a Parker-Kalon Assembly Engineer, design and production executives also frequently find that Hardened Self-tapping Screws can be successfully used for seemingly impractical applications.

PARKER-KALON CORPORATION  
198 Varick Street, New York, N. Y.

*Every day reports like these come from PARKER-KALON ASSEMBLY ENGINEERS . . . See how it pays to employ their specialized knowledge in a study of fastening jobs*



Roland Roe

it is obvious that savings on this will run to about four cents per unit. Twenty tapping operations are eliminated.

J. E. Borchard

under the former practice they had to reinforce the 18 gauge stock which was unhandy and too expensive



A. W. Meader

found that by using a Type "Z" with a special head like attached sketch, installation of the part will become a much simpler task

J. J. Mathe

through this they will be able to speed up production of this part almost 50%, and save a good deal of labor.



J. J. Mathe

rejects and scrapping of mistapped parts have been high. Mr. J . . . is delighted with the elimination of this expense and the saving of the tapping

J. M. Hogland



change I recommended should save two operations on the assembly, and produce stronger units. On another assembly

G. B. Gordon

Mr. S . . . much pleased with results obtained by driving our Type "U" with a kick press as suggested. A saving of 35%

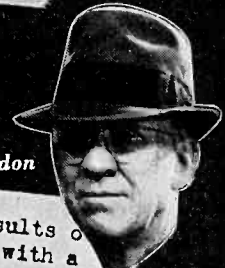

## PARKER-KALON *Modern* FASTENING DEVICES

TYPE "Z" HEX CAP A HARDENED SELF-TAPPING SCREW FOR EVERY KIND OF ASSEMBLY TYPE "A" TYPE "U"

Record Piano Music at  $33\frac{1}{3}$  R.M.P.

**UNIVERSAL  
Professional  
Recording  
Machine**

New, improved design—Scientifically correct—Superlative performance—Solid, heavy, dependable—Precision machined for long and continued use—16-in. distortion proof turntable disc—Constant speed rim drive—110 volt A.C. 100% synchronous reversible motor—Individually calibrated timing bar provides for both  $33\frac{1}{3}$  and 78 R.P.M. at 90, 110, and 130 lines per in.—Solid steel bar slide—The climax of four years of research and experiment—Positively the last word in instantaneous recording equipment. Write for latest folder giving detailed description.

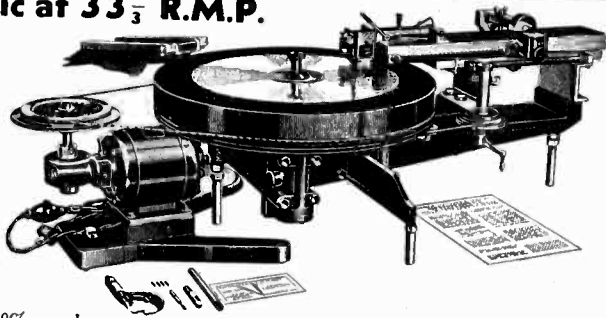

**UNIVERSAL MICROPHONE CO., Ltd.**  
424 Warren Lane, Inglewood, Calif., U. S. A.



**Insulated Wire . . .**

Whether it requires a Simple Free Push Back or a Line Cord in Rubber or Silk—or even a multiple cable—Thousands of manufacturers depend on us for their production.

Write us for quotations.

General Sales Office

**GENERAL INSULATED WIRE CORP.**  
53 PARK PLACE, NEW YORK CITY

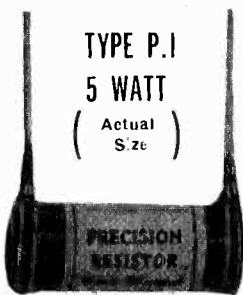

TYPE P.1  
5 WATT  
(Actual S.2c)

**POWER RESISTORS**  
which assure high quality and accuracy at an economical price

These units enjoy wide acceptance by motor manufacturers, motor service men, the radio service field, amplifiers, etc., as well as by P. A. Equipment manufacturers, inexpensive meter manufacturers, etc. They can be depended on for accuracy within 2%, and assure high quality at low price. Available in 5-10 and 20-watt sizes with maximum resistances of 30,000, 50,000 and 100,000 ohms respectively. Write for details and prices.

CUSTOM-BUILT WIRE WOUND RESISTORS

**MICROHM**  
**WIRE WOUND RESISTORS**

PRECISION RESISTOR CO., 334 Badger Ave., Newark, N. J.

**DYNAMIC MICROPHONES**

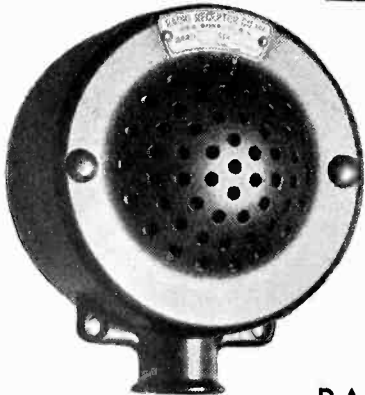

ARE INCREASING IN POPULARITY

*because they*

- have greater sensitivity
- are free from inductive pickup
- have no background noise
- can work with long lines
- are sturdiest ever produced
- are weatherproof
- are small in size
- are reasonable in price

Write for Latest Bulletin No. 3013

**RADIO RECEPTOR COMPANY, INC.**  
108 SEVENTH AVE. NEW YORK, N. Y.

**Headphones**

BRUSH DEVELOPMENT COMPANY, E. 40th at Perkins Avenue, Cleveland, Ohio, announces two new models of crystal headphones. These are single phone instruments, one with a head band and soft rubber pad which holds the phone securely in place against the ear; the other has the phone mounted on a twelve inch lorgnette handle.

**New Tubes**

The following new tubes have been announced recently:

**National Union**—The following battery tubes, requiring a heater current of 0.15 amperes instead of the conventional 0.3 amperes, are available: 6S7G, a remote cut-off amplifier; 6D8G, electron-coupled converter; 6L5G, voltage amplifier with an application factor of 17; 6Q6G, a diode-high-mu triode; 6N5, tuning indicator.

**Raytheon**—6L6G, 1F5G, similar to 1F4; 1D5G, similar to 1A4; 6B8, similar to the glass 6B7; RK-36, high efficiency, ultra high frequency triode; RK-33, double triode; 6D8G, 6S7G, 6L5G, 6Q6G, and 6N5, 150 ma. heater current type glass tubes, 25 B6G—a new 43.

**Continental**—Cetron type CE-20, caesium-argon photocell specially designed for use with 16 mm. projectors.

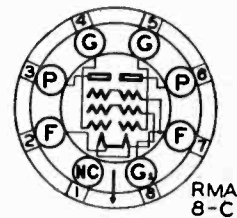

**Arcturus**—6L6G beam amplifier tube; 6B6; 6N7G; 6P7; 6Q7G; 6X5G; 25A6G; 25Z6G.

**Ken-Rad**—6B8 and 6B8G all-metal and glass with octal base tubes similar to the 6B7. 6G5, remote cut-off indicator tube. Ken-Rad states that satisfactory performance can now be obtained with the 6E5 at a maximum plate voltage of 100 volts.

**Hytron**—25A7, a rectifier power output pentode.

**RCA**—6G5 electron ray tube of the indicator type with a remote cutoff triode.

**RCA**—920 twin phototube of the gaseous type. Has two separate units in one bulb. For use with dual sound track motion-picture equipment. RCA-1603 pentode amplifier. Designed to have low-noise and low-microphonic characteristics. Intended for use in high-gain pre-amplifiers.

**Westinghouse Lamp**—WL-460; a 250-watt triode oscillator for short wave therapy machines delivers 250 watts at 6 meters. Plate voltage 2500; thoriated tungsten filament.

WEATHERPROOF WIRE

MAGNET WIRE

SERVICE ENTRANCE CABLE

CRESELEX NON-METALLIC SHEATHED CABLE

BARE WIRE

# CRESCENT CORD SETS WITH PARTS—READY TO INSTALL

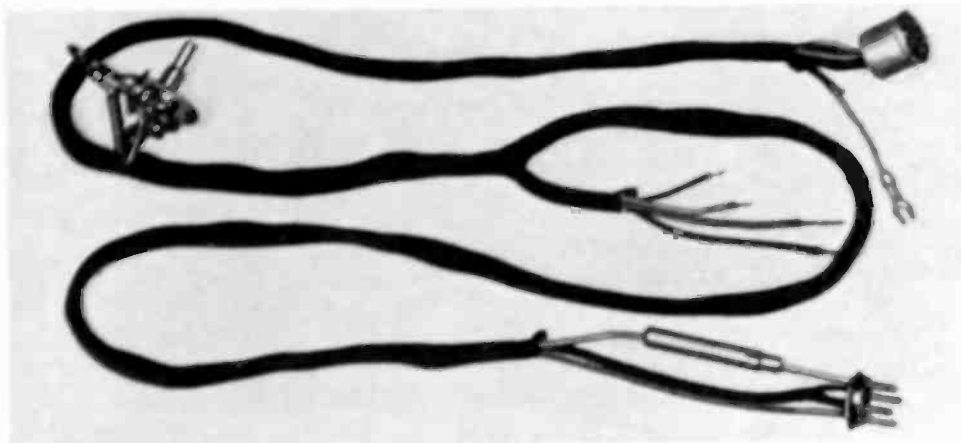

## RADIO MANUFACTURERS

*Make Big Savings with*

## CRESCENT COMPLETE CORD SETS

*WRITE US—We will be glad to show you samples of work we are doing. Address Department E.*

We are making large savings for radio manufacturers by assembling their cords complete with switches, sockets, fittings, etc. We specialize in this work. Our testing and inspection is complete and we guarantee 100% perfect cords ready for installation. Send us your blue prints for prices on quantity production.

- RECEIVER CORDS
- ASSEMBLY CORDS
- ANTENNA CORDS
- SHIELDED CORDS



Address Department E.



CRESCENT ENDURITE SUPER-AGEING INSULATION

RUBBER POWER CABLES

FLEXIBLE CORDS

RADIO WIRES

LEAD ENCASED CABLES

PARKWAY CABLE

VARNISHED CAMBRIC

SIGNAL CABLE



**L**ESS than a year has elapsed since Cinaudagraph introduced the **MAGIC MAGNET SPEAKER**. The revolutionary principles embodied in this fine speaker have definitely given it first place in the radio industry.

Engineers, manufacturers, assemblers of P.A. equipment, service technicians, have placed their stamp of unqualified approval on **MAGIC MAGNET SPEAKERS**.

Have your secretary request descriptive literature and engineering data . . . **TODAY.**

**CINAUDAGRAPH CORPORATION**  
Speaker Division, Dept. "S" • Stamford, Conn.

**CINAUDAGRAPH**

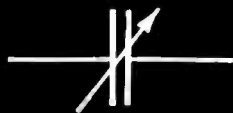

*Space is Valuable!*

*Compressed gas condensers—variable and fixed—provide the logical solution.*

*Among our users*

**KMOX** --St. Louis

**WBBM** --Chicago

**KYW** --Philadelphia

**KWKH** --Shreveport

*There's a reason . . .  
Let us explain*

**HEINTZ AND KAUFMAN**  
SOUTH SAN FRANCISCO CALIFORNIA U. S. A.

## Loudspeakers

Unusual in construction, a new Quam-Nichols Co., 1623 W. 74th, Chicago, Ill., chromatic speaker has, according to the manufacturer, better sensitivity than a dynamic and more volume than a magnetic. It has a snubbing device which prevents rattle on high amplitude notes but which does not affect the normal sensitivity. High amplitude vibrations are damped by rubber pads.

• •

A loud speaker unit with high sensitivity due to the lightness of the diaphragm and voice coil and high magnetic efficiency in handling 25 watts has been announced by Fox Sound Equipment Corporation, Toledo, Ohio. It is suited for public address and theatre systems where tone shades, whispers and light musical effects are as important as heavy orchestral and organ volume. It has a one-piece metal diaphragm, 0.002" thick.

• •

LANSING MANUFACTURING COMPANY, Los Angeles, California, extends its line of speakers by adding the Monitor designed for program monitoring, high-quality speech reinforcement and deluxe radio receiver use. It is an outgrowth of the development of the Lansing-Shearer two-way horn system described in *Electronics*, March, 1936. Its dimensions are, 50" wide, by 27" high by 27" deep. It has high efficiency and smooth response from 50 to 8,000 cycles.

• •

New replacement speakers available in 5", 6", 8", 10" and 12", sizes from Operadio Manufacturing Company, St. Charles, Illinois. These speakers are available with universal matching transformers and standard field coil ratings. Operadio offers a unique time payment plan on this junior series radio replacement speakers. Operadio also offers a mobile public address system known as Model 112, which operates from a 6-volt storage battery and delivers 20 watts class A power output.

• •

THE MAGNAVOX COMPANY, Fort Wayne, Indiana, states that the new Model 305-15 inch speaker recently introduced gives set manufacturers an opportunity to enhance sales appeal, performance and quality of their receiving sets. It will handle 6L6 outlet tubes, has a frequency range of 40 to 6000 cycles, according to the bulletin, and furthermore, has eye appeal. It lists at \$30.00.

## PROFESSIONAL SERVICES

### BLILEY ELECTRIC CO.

*Designers—Manufacturers*  
Quartz Crystals for standard or special radio frequency applications.

Inquiries Invited.  
240 Union Station Bldg.  
Erie, Penna.

### EISLER ENGINEERING CO.

*Consulting, Designing & Mfg. Engineers*  
Electric Welding Problems, High Vacuum Compound Pumps, Soft and Hard Glass Working Equipment, Radio and Electronic Tube Machinery  
Special Machinery built to your specifications  
753 So. 13th St. Newark, N. J.

### ELECTRICAL TESTING LABORATORIES

Characteristics and *Life Tests of Vacuum Tubes*  
Tests of photo cells, glow lamps, crater lamps.  
Tests of electronic and optical devices.  
80th Street and East End Avenue  
New York, N. Y.  
Phone: Butterfield 8-2800

### BERNARD EPHRAIM, E. E.

*Expert Foreign Technical Translator*  
Patent Specifications Engineering Articles  
French, Spanish, Italian, German  
Box 4049, San Francisco, California

### THAD R. GOLDSBOROUGH

REGISTERED PATENT ATTORNEY  
*Westinghouse Electric, 1925-1930*  
*Patent Attorney, RCA Victor, 1930-1935*  
Fifteen years familiarity with patent matters relating to Talking Movies, Television, Radio and Electronics.  
201-205 McLachlen Building  
Washington, D. C.

### HUDSON BROS. MFG. CO., Inc.

539-41 42nd St., Union City, N. J.  
Designers and consultants for experimental glass apparatus, pyrex and soft glass.  
Aspirator Pumps Ground Joints  
Graded Seals Stop-Cock Grease  
Stop-Cocks Pyrex and McLeod Gauges  
Soft Glass Traps of all types.  
Glass Apparatus Made to Blue Print Specifications.  
Tel. Fallsade 6-2940

## PROFESSIONAL ASSISTANCE

in the solving of your most difficult problems in the highly specialized field of electronic devices is offered by consultants whose cards appear on this page.

# CERAMIC PROGRESS

*Alsimag & Lava*

Used by Bell Telephone Laboratories, Western Electric Company and other leaders

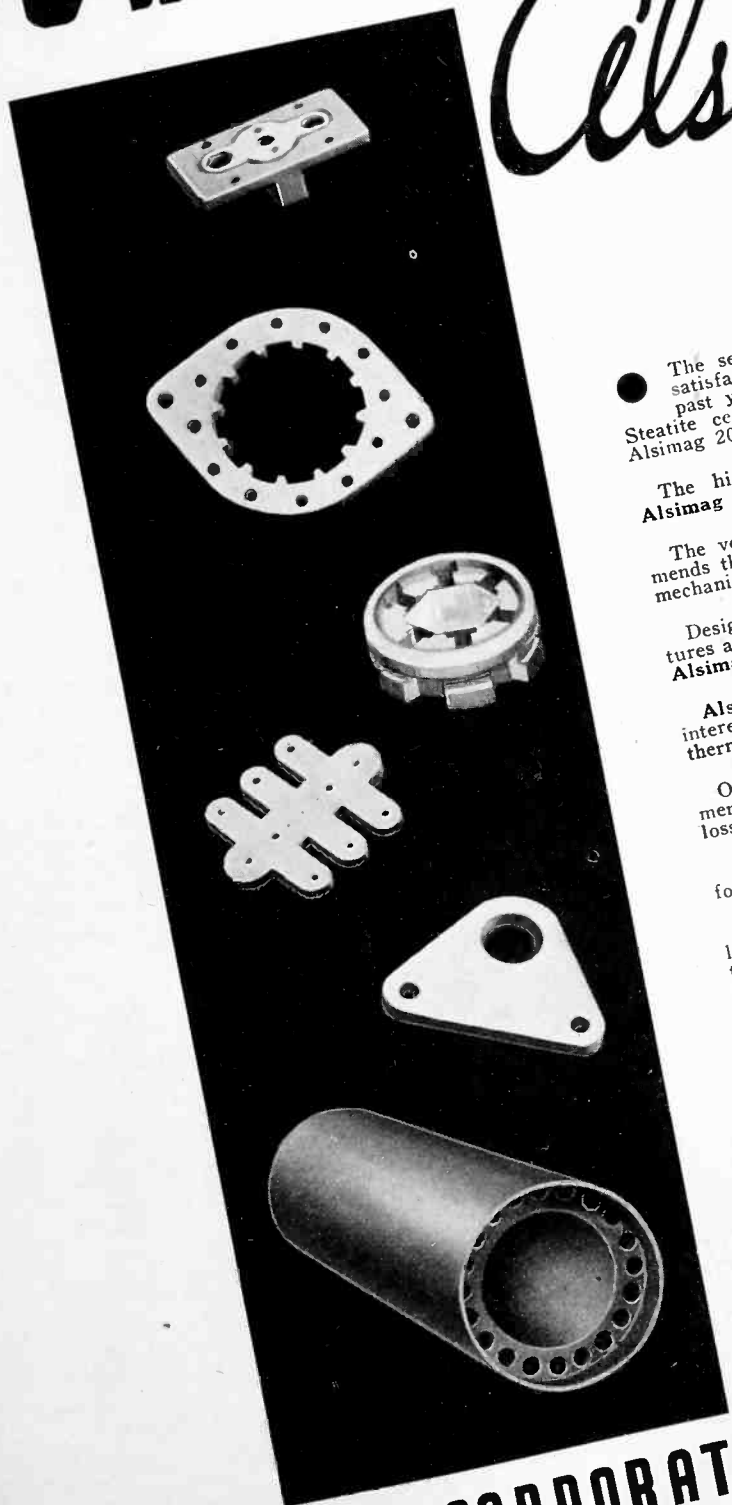

● The several ALCO ceramics are carefully designed to suit satisfactorily various engineering requirements. During the past year our research laboratory has released the superior Steatite ceramics Alsimag 192, Alsimag 196, Alsimag 197 and Alsimag 202.

The high dielectric constant and low power factor makes Alsimag 192 an ideal ceramic for use in condensers.

The very low loss factor of ultra-steatite Alsimag 196 recommends this body for all high frequency applications. The unusual mechanical properties make it obviously superior in its field.

Designed to meet the rigid requirements where high temperatures are encountered and used especially by range manufacturers, Alsimag 197 has been enthusiastically received.

Alsimag 202 with its low coefficient of expansion will be of interest to those engineers seeking a ceramic body with excellent thermal shock properties.

Our standard Alsimag 35 has for many years met the requirements of engineers for a dense Steatite body with low electrical losses and exceptional mechanical strength.

Alsimag 72 for thermocouples and Alsimag 203, a porous body for resistance, have special applications well known to engineers.

Lava (machined Steatite) where limited quantities or watch-like accuracy are desired—experimental samples machined from the crude material without any die expense. Extensively employed in electronic tubes.

Our engineers and laboratories are at your disposal to work out a body to meet special needs.

If ALCO supplies your ceramics your engineers are not limited to one body.

Write us today for additional information and samples of such Alsimag bodies as are of interest to you, instructing your Purchasing Department to secure our attractive prices on your insulating parts.

34th Year of Ceramic Leadership

**AMERICAN LAVA CORPORATION - Chattanooga, Tenn.**

OUR OWN BRANCH OFFICES  
 LOS ANGELES  
 SAN FRANCISCO  
 ST. LOUIS  
 CHICAGO  
 CLEVELAND  
 BOSTON  
 NEW YORK  
 PHILADELPHIA  
 TORONTO

# TESTED-ACCEPTED

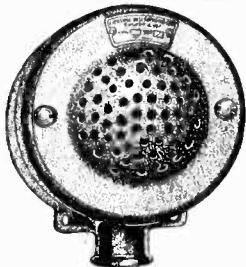

## BY LEADING SOUND MEN and BROADCASTING STATIONS

Amplifier costs—parasitic and tube noises are reduced by the high sensitivity of the new LIFETIME (moving coil) DYNAMIC MICROPHONE.

Numerous features such as lack of background noise—freedom from inductive pickup—high sensitivity—sturdy construction—amazingly low price—are turning the trend to LIFETIME DYNAMIC MICROPHONES.

Send today for complete data on America's OUTSTANDING VALUES in microphones and Sound Equipment.

**THE LIFETIME CORP., 1000 Madison, TOLEDO, OHIO**



## Frequency Measuring Service



Many stations find this exact measuring service of great value for routine observation of transmitter performance and for accurately calibrating their own monitors.

MEASUREMENTS WHEN YOU NEED THEM MOST

**R.C.A. COMMUNICATIONS, Inc.**

Commercial Dept.

A RADIO CORPORATION OF AMERICA SERVICE

66 BROAD STREET

NEW YORK, N. Y.

## LEACH LR RELAYS

### POSITIVE PROTECTION

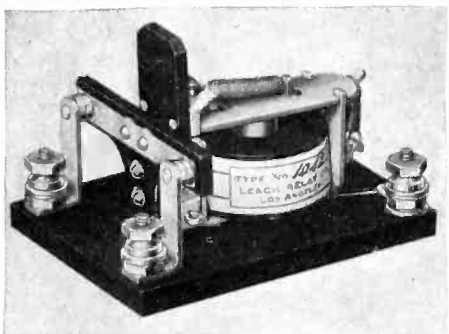

For Your Power Tubes. These light duty overload trip relays have a wide field of use as safety devices on electronic apparatus. Operation is unusually dependable. Scores of nationally known concerns rely on Leach Relays for protection.

#### Leach Relay Company

5915 Avalon Boulevard,  
Los Angeles, Calif.

SEND  
COUPON

Leach Relay Co., 5915 Avalon Boulevard, Los Angeles, Calif.  
Please send me your catalog.

Name

Company

Address

City

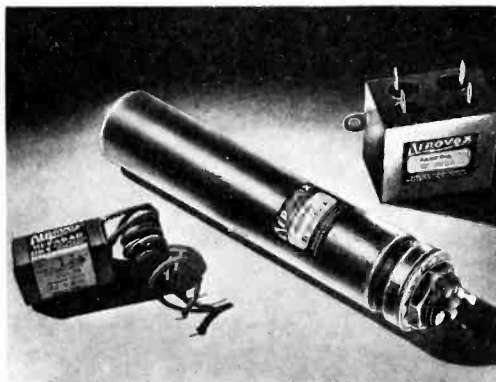

## CONDENSERS



... fitted to the job

Design that assembly much as you please. For when it comes to condensers, AEROVOX can meet any requirement. • Most likely you can utilize standard AEROVOX units, because of the remarkable variety offered. • Otherwise, AEROVOX can make special units to meet the most peculiar needs. • In either event, the low cost will always reflect the savings of a great plant guided by an outstanding engineering staff.

Write for latest catalog covering the extensive line of condensers and resistors. Meanwhile, submit problems for engineering aid and quotations.

# AEROVOX

CORPORATION

75 Washington St. :: Brooklyn, N. Y.

## Turret Projector Horn

THE OPERADIO MANUFACTURING CO., St. Charles, Ill., has developed a horn especially designed for projecting from a dynamic cone speaker. The horn is made of spun brass and



is designed to give adequate rear pressure relief for the speaker cone. It is designed for a speaker of 10-in. diameter only. Overall dimensions are 17 in. long and 18 in. diameter at the bell. The finish is black enamel. The net weight is 5 lb.

The newest offering of Operadio is the Model 44 acousti-reflex speaker cabinet. Designed to minimize feed-back difficulties and increase speaker efficiency, it affords better coverage with less amplifier power output. Accommodates electro-dynamic speakers of the 12" size, such as the E-4 series. Has an inbuilt exponential chamber which takes sound from the back of the cone and expands it in a normal manner, and projects it to front to augment the sound volume generated by the front speaker cone.

## Rectifier Tube

AMPEREX ELECTRONIC PRODUCTS, INC., 79 Washington Street, Brooklyn, New York, recently announced a mercury-vapor rectifier known as the 575-A. Similar in design to the 869-A, it has

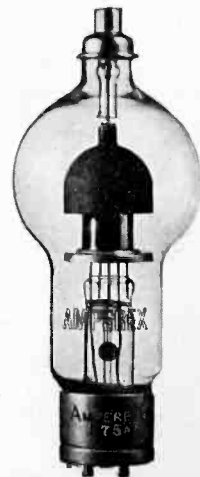

slightly lower voltage-current characteristics. Has the standard 50 watt base; average plate current, 1.5 amperes; filament voltage, 5 volts a.c.; filament current, 10 amperes; peak in-10½" long, 3⅜" diameter; .500" plate verse voltage, 15,000 volts. Dimensions: cap diameter.

# BIG RESOURCES FOR BETTER SERVICE ON INSULATING MATERIAL

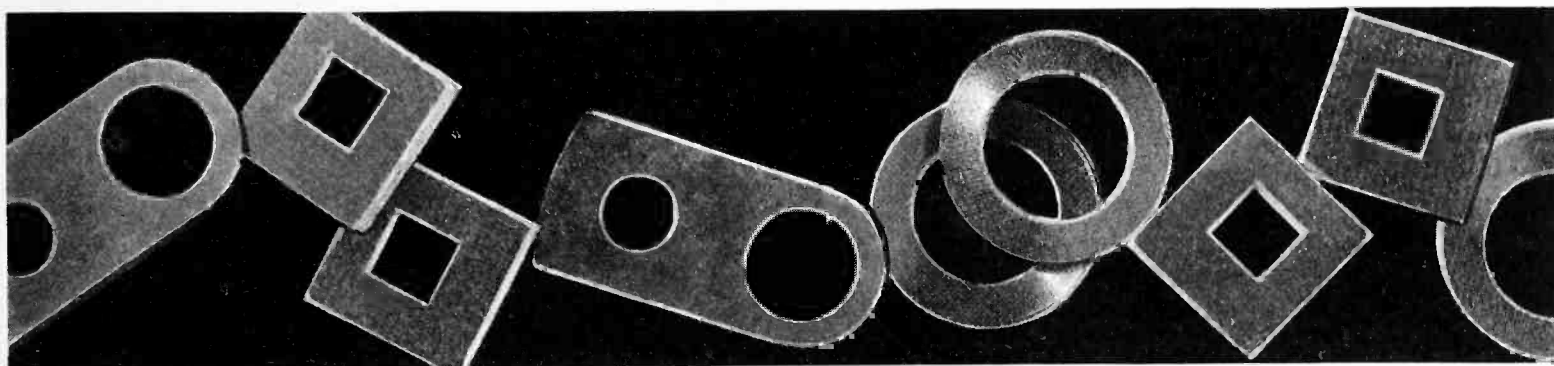

The resources of the Formica Insulation Company for providing high quality, uniform, laminated insulating parts include: One of the largest manufacturing plants in the industry. One of the largest and most varied equipments of fabricating machinery. A well manned and equipped laboratory which has consistently kept Formica abreast of the art, and developed many new qualities and features that are available only in Formica. A location near the center of industry where quick shipment to most plants is possible. For quality and service, try Formica. Send us your blue prints on parts or your inquiries for sheets, tubes and rods.

THE FORMICA INSULATION COMPANY  
4638 Spring Grove Avenue • • • Cincinnati, Ohio

## FORMICA

## AUDIO OSCILLATOR

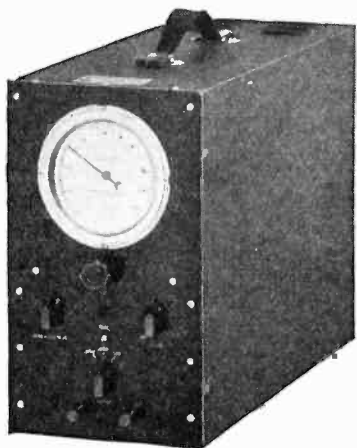

TYPE CR-4 BEAT FREQUENCY AUDIO OSCILLATOR—Price **\$77<sup>00</sup>**

- Portable, A.C. Operated.
- 10 cps to 20,000 cps.
- Reed for Calibration Check.
- High and Low Impedance Outputs.
- Direct Reading Dial. Accuracy 2%.
- Low Hum and Distortion.
- High Output; 30 volts Max.
- Drift after warmup Negligible.

Write for Catalog

**UNITED SOUND ENGINEERING CO.**  
Manufacturers of Electronic Equipment  
2235 University Ave.—St. Paul, Minn.

—and **HOW**  
**THEY PERFORM!**

**SHURE**



*Crystal*  
**Microphones**

The **8** exclusive features built into Shure "ULTRA" Microphones mean just *one thing*—**SUPERB MICROPHONE PERFORMANCE**—thrilling life-like reproduction—dependable 24-hour-a-day service—at low cost.

Make your own tests—satisfy yourself now that Shure "ULTRA" is the Best Microphone Buy!

**FREE!** New Microphone Applications Chart. Write for your copy of Chart 227M now.

**SHURE MICROPHONES**  
SHURE BROTHERS • MICROPHONE HEADQUARTERS  
225 WEST HURON STREET • CHICAGO, U. S. A.



MODEL 700A

Available in Swivel, "Grille-Type" and Spherical models. List Price each model, complete with cable, \$25. Write for Bulletin 140M today! Licensed under patents of the Brush Development Company. Shure patents pending.

## Portable Volt-wattmeter

A NEW COMBINATION volt-wattmeter of the Type AP-9 series of portable instruments, consisting of a voltmeter and a wattmeter fitted into a standard AP-9 case, has been announced by the



General Electric Company. Either rating may be used by throwing a switch located on the top of the instrument.

The instrument has an over-all accuracy of  $\frac{1}{4}$  of one per cent of full-scale value. As with other Type AP-9 instruments, the new volt-wattmeter has magnetic damping, the new Permalloy moving vane, and is shielded from stray magnetic fields. The case is of Textolite.

## Micromax

MARKING THE 25TH YEAR since Leeds and Northrup, 4934 Stenton Avenue, Philadelphia, Pennsylvania, originated

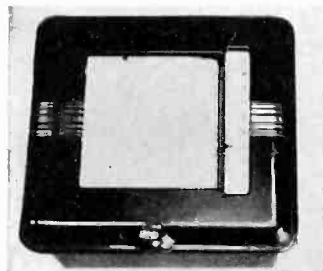

the recording potentiometer pyrometer, this company makes available the silver anniversary Micromax recorder. It provides in one instrument all combinations of indicating, recording, signaling and controlling. Catalog N-33A describes it.

## Volume Control

A METALLIZED type volume control with multi-finger, silver-plated contacts high stability, has been announced by International Resistance Company, Philadelphia, Pennsylvania. It is known as Type C, and a detailed description from the manufacturer points out its special virtues for use by the radio and sound industries.

Now—

a high-powered—

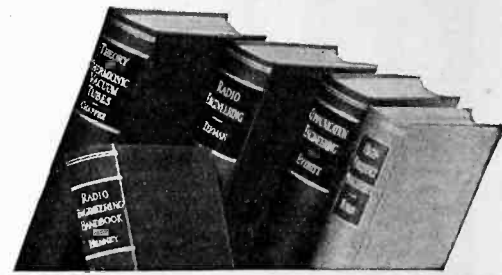

## RADIO ENGINEERING LIBRARY

— especially selected by radio specialists of McGraw-Hill publications

— to give most complete, dependable coverage of facts needed by all whose fields are grounded on radio fundamentals

— available at a special price and terms

These books cover circuit phenomena, tube theory, networks, measurements, and other subjects—give specialized treatment of all fields of practical design and application. They are books of recognized position in the literature—books you will refer to and be referred to often. If you are a researcher or experimenter—if your interest in radio is deep-set and based on a real desire to go further in this field—you want these books for the help they give in hundreds of problems throughout the whole field of radio engineering.

5 volumes, 2981 pages, 2000 illustrations

1. Everitt's COMMUNICATION ENGINEERING
2. Terman's RADIO ENGINEERING
3. Chaffee's THEORY OF THERMIONIC VACUUM TUBES
4. Hund's HIGH-FREQUENCY MEASUREMENTS
5. Henney's RADIO ENGINEERING HANDBOOK

Special Low Price and Easy Terms

Bought singly, the five volumes comprising this library would cost you \$26.00. Under this offer you save \$2.50 and, in addition, have the privilege of paying in easy installments beginning with \$2.50, 10 days after receipt of the books, and \$3.00 monthly thereafter. Already these books are recognized as standard works that you are bound to require sooner or later. Take advantage of these convenient terms to add them to your library now.

### SEND THIS ON-APPROVAL COUPON

McGraw-Hill Book Co., Inc.  
330 W. 42nd St., New York, N. Y.

Send me Radio Engineering Library 5 vols., for 10 days' examination on approval. In 10 days I will send \$2.50, plus few cents postage, and \$3.00 monthly till \$23.50 is paid, or return books postpaid. (We pay postage on orders accompanied by remittance of first installment.)

Name .....

Address .....

City and State .....

Position .....

Company ..... L 9-30

(Books sent on approval in U. S. and Canada only.)



# The **SMALLEST** **1/3-WATT** **RESISTOR**



## SPACE SAVING

Clearance must be provided around resistors to prevent grounding or short circuiting.

**NEW WAY**

**OLD WAY**

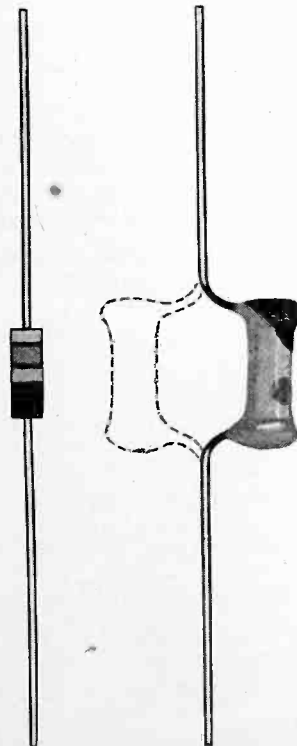
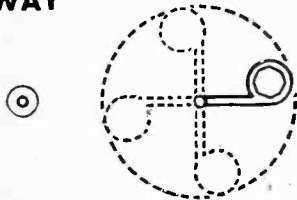

Type E resistors, with leads attached longitudinally to the center of the resistor, cannot swing out of line and cause accidental grounding or short circuits. No special care is needed in placing the resistor.

Old style resistors, with leads attached radially to ends of resistor, can swing around a wide circle. Special care must be taken when soldering to install resistor in correct position.

## Easily Mounted in Small Sets Cuts Your Chassis Assembly Cost

The new Allen-Bradley Type E solid molded resistor, with straight line leads, is the smallest 1/3-watt resistor on the market!

It is so tiny that it can be tucked into the smallest under-chassis spaces, but electrical and mechanical safety factors are as high as ever. Specially tempered leads eliminate sharp bends that cause lead breakage. The absence of externally connected leads further reduces the overall size of the type E resistor unit.

Another novel feature is the indexed carton which holds 500 resistors in neat and convenient order for the assembly line. The resistor leads are always straight—there is no tangling—no fumbling—no delays. A quick inventory of resistors can be noted from the graduated scale on the carton. The color-coding is visible in all positions.

Modernize your production methods and improve your receivers by standardizing on this Allen-Bradley molded resistor.



A carton of 500 Allen-Bradley Molded Resistors, ready for the assembly line.

Allen-Bradley Company  
110 W. Greenfield Ave. Milwaukee, Wis.

# ALLEN-BRADLEY RADIO RESISTORS

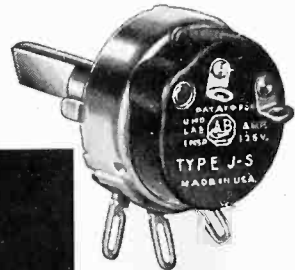

Standardize on Type J Bradleyometers—made with or without line switch—for volume and tone control.

## Announcing THE SIGMA SENSITIVE RELAY



Jewelled movement.  
Balanced to operate in any position.  
Positive operation on 4 milliwatts, D. C.  
Single pole, double throw.  
Mounts in standard 5-prong tube socket.  
A useful adjunct to  
V. T. controls  
Supervisory and alarm circuits  
Signalling.

**SIGMA INSTRUMENTS,  
INC.**

388 Trapelo Road, BELMONT, MASS.

## .00001 Ohm to 11 Megohms SHALLCROSS

### HI-LO RESISTANCE BRIDGE

A direct reading instrument for the measurement of low resistances encountered in mechanical joints, coil windings and armature windings, as well as all other resistance of any character within the range of the bridge.

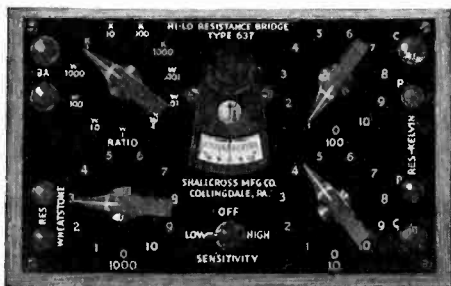

Combines in one instrument a standard Kelvin Bridge and a standard Wheatstone Bridge for measuring resistances from 0.00001 ohm to 11 megohms.

Send for Bulletin 637-KA  
describing this instrument.

**SHALLCROSS MFG. CO.**  
COLLINGDALE, PA.

## "Flexidons"

A NEW ELECTROLYTIC condenser design announced by the Tobe Deutschmann Corporation, Canton, Mass., features unit or "Flexidon" construction which permits the removal of any single section of a multiple section condenser in case of failure. Obviously, the rest of the condenser is salvaged, with resulting replacement economy. Individual sections have separate positive and negative leads. Made in the usual capacities up to and including 16 microfarads. A companion item, the replacement section, is known as the "Unidon".

## Plugs and Receptacles

A NEW SERIES of 20 ampere units designed for multiple circuits of from 4 to 16 holes, 250 volts d-c, 460 volts a-c,

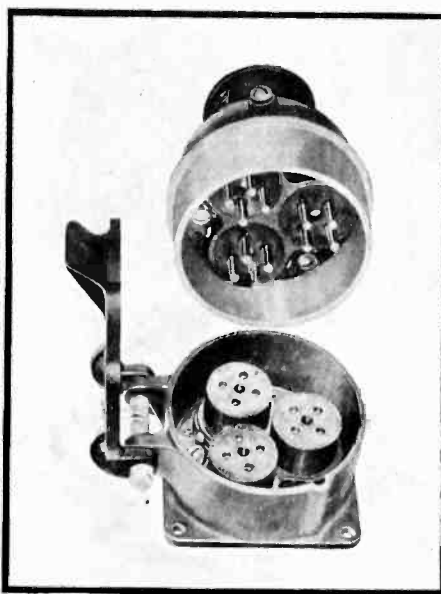

is available from Pyle-National Company, 1334 North Kostner Avenue, Chicago, Illinois. Bulletin 198 describes and lists these devices which are adapted to remote control circuits, thermo-couple connections, sound equipment and other portable apparatus.

## Trumpets

ATLAS SOUND CORPORATION, 1451 39th. Street, Brooklyn, have added to their line of production an inexpensive driver

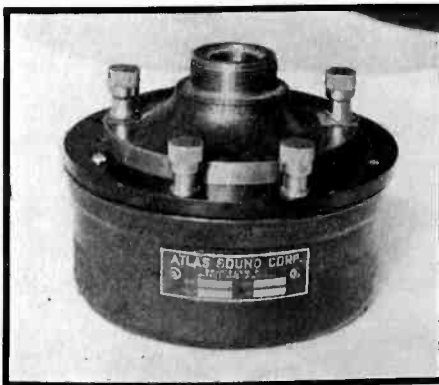

unit Model GU-3 of 20 watt capacity and a six foot storm proof trumpet horn, Model KD-6 made of durable, unbreakable, weather-proof, acoustical material. List, \$25.00 each.

## Hearing Aids

A SMALL PORTABLE battery operated hearing aid device, suitable for office and desk use has been developed by Dr. Christian A. Volf. This executive transmitter will be sold by Dictograph Products Corporation, 580 Fifth Avenue, New York City.

This device consists of a microphone encased in a hemispherical cup which

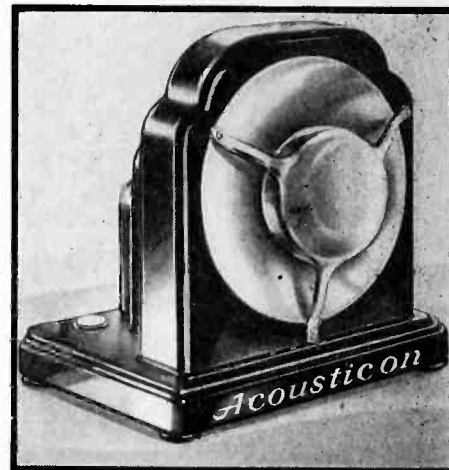

faces directly into a highly polished pewter sound concentrator, a battery with a mechanical amplifier, a rheostat to control the volume, and a voltmeter to test the battery. These parts are assembled in various attractive modern cases made of aluminum, bakelite, and mahogany.

Owing to larger acoustical cavities, the tone qualities of this transmitter have been greatly improved over the ordinary hearing aid microphone. Due to the sound concentrator, the pick up range of this microphone is very remarkable, making a whisper audible at 200 feet. Furthermore, it has some directional effects; thereby making it possible to reduce unpleasant noises coming in from open windows. Unlike the electron tube amplifiers which generally need an outside source of electrical power supply, the executive transmitter is entirely self-contained making it so portable that it can be used with equal readiness in the theatre, home, office or on picnics.

## Switches

CENTRALAB, 900 East Keefe Avenue, Milwaukee, Wisconsin, has developed a new switching device for use in radio circuits where a low loss, low capacity multi-section switch is required. This switch incorporating a true Isolantite base, to which are attached sturdy, double-bite clips with low contact resistance and free from all looseness or rocking, is available in a multiplicity of designs.

The wax impregnated Isolantite base, incorporating material with an exceedingly low loss factor, will find great usefulness in any high frequency or ultra high frequency switching circuit where excessive losses become the controlling factor in design.



**ACHIEVED!**

A solution of the problem of Steatite manufacture at high daily output and reasonable price has been found by General Ceramics. Steatite by General Ceramics now flows along the production lines of the largest manufacturers like any other article produced in the modern order of mass fabrication. This accomplishment takes highest honors for ceramic achievement in 1936.

If a direct buyer of R. F. ceramics, you should know more about General Ceramics Steatite. If a buyer of articles incorporating ceramics you should insist that your supplier investigate it. General Ceramics Steatite will cut your costs, reduce failures, promote electrical performance and aid you in many ways. General Ceramics Steatite is a tough, strong, non-hygroscopic body, low in loss. Get the facts on General Ceramics Steatite.

**GENERAL CERAMICS COMPANY**  
RCA BUILDING, NEW YORK

*Marketing Agents*

**DIELECTRIC PRODUCTS CORPORATION**  
245 CUSTER AVENUE, JERSEY CITY, N. J.  
174 NORTH WACKER DRIVE, CHICAGO, ILL.

## Announcing THE SIGMA SENSITIVE RELAY



Jewelled movement.  
Balanced to operate in any position.  
Positive operation on 4 milliwatts, D. C.  
Single pole, double throw.  
Mounts in standard 5-prong tube socket.  
A useful adjunct to  
V. T. controls  
Supervisory and alarm circuits  
Signalling.

**SIGMA INSTRUMENTS,  
INC.**

388 Trapelo Road, BELMONT, MASS.

## .00001 Ohm to 11 Megohms SHALLCROSS

### HI-LO RESISTANCE BRIDGE

A direct reading instrument for the measurement of low resistances encountered in mechanical joints, coil windings and armature windings, as well as all other resistance of any character within the range of the bridge.

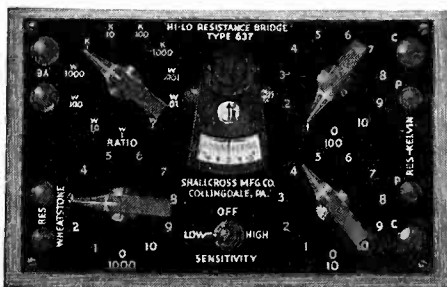

Combines in one instrument a standard Kelvin Bridge and a standard Wheatstone Bridge for measuring resistances from 0.00001 ohm to 11 megohms.

Send for Bulletin 637-KA  
describing this instrument.

**SHALLCROSS MFG. CO.**  
COLLINGDALE, PA.

## "Flexidons"

A NEW ELECTROLYTIC condenser design announced by the Tobe Deutschmann Corporation, Canton, Mass., features unit or "Flexidon" construction which permits the removal of any single section of a multiple section condenser in case of failure. Obviously, the rest of the condenser is salvaged, with resulting replacement economy. Individual sections have separate positive and negative leads. Made in the usual capacities up to and including 16 microfarads. A companion item, the replacement section, is known as the "Unidon".

## Plugs and Receptacles

A NEW SERIES of 20 ampere units designed for multiple circuits of from 4 to 16 holes, 250 volts d-c, 460 volts a-c,

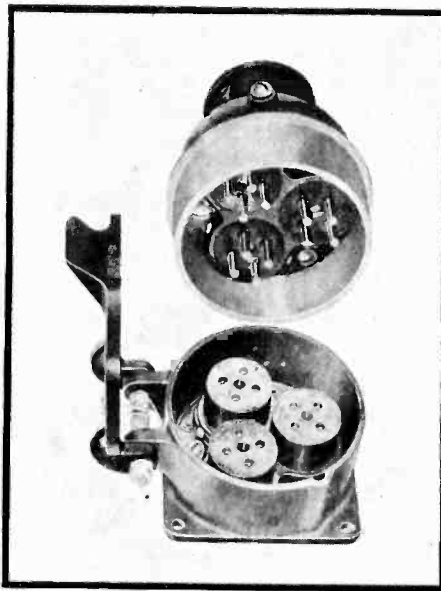

is available from Pyle-National Company, 1334 North Kostner Avenue, Chicago, Illinois. Bulletin 198 describes and lists these devices which are adapted to remote control circuits, thermo-couple connections, sound equipment and other portable apparatus.

## Trumpets

ATLAS SOUND CORPORATION, 1451 39th Street, Brooklyn, have added to their line of production an inexpensive driver

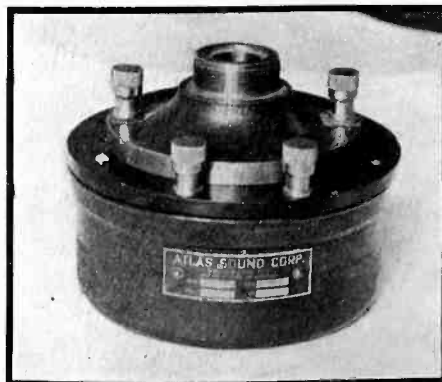

unit Model GU-3 of 20 watt capacity and a six foot storm proof trumpet horn, Model KD-6 made of durable, unbreakable, weather-proof, acoustical material. List, \$25.00 each.

## Hearing Aids

A SMALL PORTABLE battery operated hearing aid device, suitable for office and desk use has been developed by Dr. Christian A. Volf. This executive transmitter will be sold by Dictograph Products Corporation, 580 Fifth Avenue, New York City.

This device consists of a microphone encased in a hemispherical cup which



faces directly into a highly polished pewter sound concentrator, a battery with a mechanical amplifier, a rheostat to control the volume, and a voltmeter to test the battery. These parts are assembled in various attractive modern cases made of aluminum, bakelite, and mahogany.

Owing to larger acoustical cavities, the tone qualities of this transmitter have been greatly improved over the ordinary hearing aid microphone. Due to the sound concentrator, the pick up range of this microphone is very remarkable, making a whisper audible at 200 feet. Furthermore, it has some directional effects; thereby making it possible to reduce unpleasant noises coming in from open windows. Unlike the electron tube amplifiers which generally need an outside source of electrical power supply, the executive transmitter is entirely self-contained making it so portable that it can be used with equal readiness in the theatre, home, office or on picnics.

## Switches

CENTRALAB, 900 East Keefe Avenue, Milwaukee, Wisconsin, has developed a new switching device for use in radio circuits where a low loss, low capacity multi-section switch is required. This switch incorporating a true Isolantite base, to which are attached sturdy, double-bite clips with low contact resistance and free from all looseness or rocking, is available in a multiplicity of designs.

The wax impregnated Isolantite base, incorporating material with an exceedingly low loss factor, will find great usefulness in any high frequency or ultra high frequency switching circuit where excessive losses become the controlling factor in design.



**ACHIEVED!**

A solution of the problem of Steatite manufacture at high daily output and reasonable price has been found by General Ceramics. Steatite by General Ceramics now flows along the production lines of the largest manufacturers like any other article produced in the modern order of mass fabrication. This accomplishment takes highest honors for ceramic achievement in 1936.

If a direct buyer of R. F. ceramics, you should know more about General Ceramics Steatite. If a buyer of articles incorporating ceramics you should insist that your supplier investigate it. General Ceramics Steatite will cut your costs, reduce failures, promote electrical performance and aid you in many ways. General Ceramics Steatite is a tough, strong, non-hygroscopic body, low in loss. Get the facts on General Ceramics Steatite.

**GENERAL CERAMICS COMPANY**  
RCA BUILDING, NEW YORK

*Marketing Agents*

**DIELECTRIC PRODUCTS CORPORATION**  
245 CUSTER AVENUE, JERSEY CITY, N. J.  
174 NORTH WACKER DRIVE, CHICAGO, ILL.

## Production Machine

THE FLEXOPRESS model 400 made by Flexo Machines, 2226 N. Racine Avenue, Chicago, Illinois, has two applications in the radio manufacturing industry. The first is the high speed automatic cutting of production materials to uniform length up to 9 inches. Wire, insulation, spaghetti, tape, cloth, paper and light metal, can be cut off at speeds up to 80,000 strokes per hour. The second application is the stamping of small light parts, such as clips, connectors, plugs, spacers, etc. The operation of the machine is entirely automatic.

## Speech Input

REMLER COMPANY, LTD., San Francisco, California, announces a moderately priced speech input system specially engineered to meet individual station requirements. This 70-A system is a-c operated, meets the FCC requirements, may be used with dynamic, velocity, crystal condenser microphones. Single and double channel systems are available. Indicator lamps associated with each control indicate the channel used. A six-position mixer and control turret is provided with key switches to place any mixer position, the volume indicator and output line on either channel.

## Sweep Oscillator

THE CLOUGH BRENGLE Model OM-A frequency modulated r-f signal generator employs a new sweep principle. In place of complicated moving parts or involved tube circuits with consequent instability, the "Inductor Sweep" simply employs a small copper vane which is rotated in the magnetic field of the oscillator coil. As this vane rotates, it causes the inductance of the coil to vary sufficiently to cause a plus and minus 20 kc. "wobble" of the oscillator output frequency. Rotation is



secured by a synchronous motor, operating at what is practically zero load. It uses metal tubes throughout. The principle involved is also employed in the Model 81-A frequency modulator which converts any test oscillator for oscillograph use. Clough Brengle Company, 1134 West Austin Avenue, Chicago, Illinois.

## Level Indicator

A NEW sound level indicator has been announced by the Industrial Apparatus Co., of 720 N. Wabash Ave., Chicago, Ill. It is designed to measure sound levels exactly as heard by the human ear. The user can quickly secure accurate data on sound and noise levels,



thereby reducing testing and manufacturing costs. Since accurate readings can be quickly secured, manufacturers can test their production for uniform noise levels. The unit is especially valuable to the design engineer in noise level reduction work.

The model 300 sound level indicator consists of a calibrated crystal type microphone, an audio frequency amplifier with the new all metal tubes, a calibrated attenuator, an ear weighing network, a decibel meter and a crystal type headset. The range is from thirty to ninety decibels A.S.A. standard. Although designed for a-c operation, batteries may be used.

## Crystal Microphone

THE ASTATIC MICROPHONE LABORATORY, INC., of Youngstown, Ohio, has developed a new single diaphragm crystal microphone, known as Model 218, that is especially designed for effective pickup where the microphone is to be



concealed or hidden. The interior assembly is cushion mounted, permitting use under adverse conditions of vibration. It is so designed that a long cable may be used without serious loss of output. It has a wide angle uni-directional pickup with an output level of approximately -56 D.B. using a 5.0 meg. load. Net weight is 3½ ounces—is 2½" in diameter by ¾" thick—with flat back, domed screen front and provided with spring clip for attachment.

# PIONEER SILVER BAND DYNAMOTORS

THE DEPENDABLE POWER SUPPLY



for

**POLICE RADIO!  
AIRPLANE and MARINE  
SERVICE!**

Used with Equipment  
Manufactured by

**WESTERN ELECTRIC  
COMPANY**

**Other Pioneer Products**

Rotary Converters; Gen-E-Motors; Gasoline Electric Power Plants, AC or DC, from 6 to 110 Volts and 150 to 1500 Watts.

Wherever a high-quality power supply is needed PIONEER "Silver-Band" DYNAMOTORS can be depended on to give consistent, uniform service. They are your guarantee of lasting satisfaction, dependability and operating economy. Certain types of PIONEER "Silver-Band" DYNAMOTORS are specified by Bell Telephone Laboratories for use with products of the Western Electric Company.

**PIONEER GEN-E-MOTOR  
CORPORATION**

468 A West Superior St., Chicago, Ill.

# A TECHNICAL ACHIEVEMENT

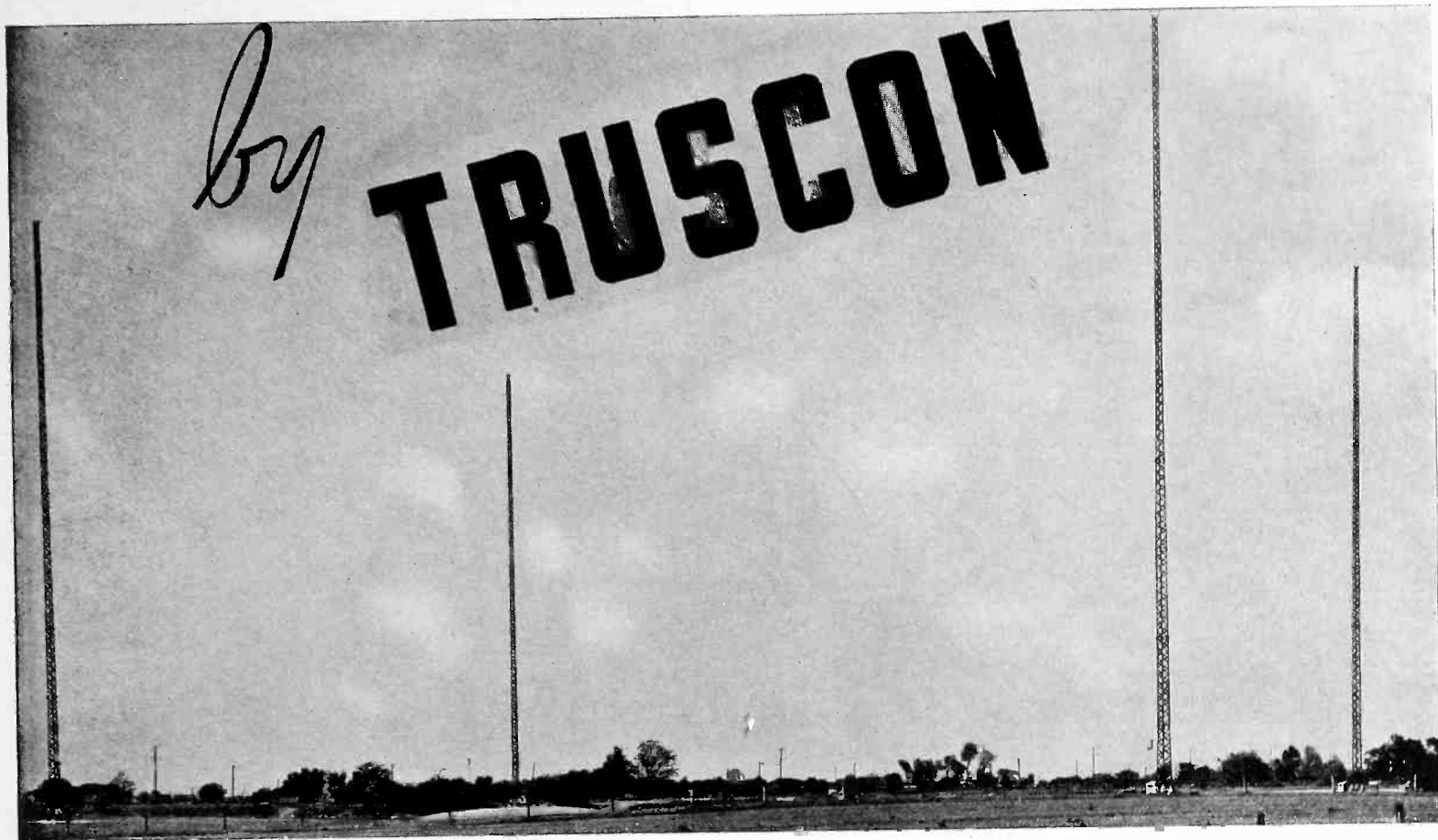

## TWO STATIONS USE SAME VERTICAL RADIATOR SYSTEM *One... DIRECTIONAL — The Other... NON-DIRECTIONAL*

● At Green Bay, Wisconsin, four Truscon self-supporting Vertical Radiators, each 196 feet high, serve two separate and distinct broadcasting stations.

Station WTAQ (1330 Kilocycles, 1000 watts) uses all four Truscon Radiators on a directional system whereby programs are broadcast in any specified direction to restrict them to any required area.

Station WHBY (1200 Kilocycles, 250 watts) uses but one of the four Truscon Radiators on a non-directional system.

Both stations utilize their respective maximum assigned power to the greatest advantage without increasing power input. Not only have both stations greatly extended their primary service areas but commercial opportunities have been increased through

better signal reception and absence of night fading.

Both stations secure an exceptionally high fidelity modulation... one of the many important advantages insured by the superior antenna performance of Truscon self-supporting vertical radiators.

The technical and commercial opportunities afforded by Truscon Vertical Radiators are gaining rapid recognition by station operators, radio consultants and engineers. Truscon offers expert cooperation in determining the most efficient and economical application of Truscon Vertical Radiators to meet YOUR specific requirements.

If you are unfamiliar with the location of the Truscon sales-engineering office in your vicinity, write direct to Truscon Steel Company, Youngstown, Ohio.

# TRUSCON VERTICAL RADIATORS

# A ray focusing anode material



Aquadag\* Brand colloidal graphite (in water) is now a standard coating on various cathode ray tubes. In its use as a ray focusing anode material, this product has the following four advantages:

1. It is easy to apply.
2. It is economical to use.
3. It adheres equally well to all types of glass.
4. It reduces light reflection because of the dark, matte surface formed on the glass.

Technical Bulletin No. 191B giving detailed information is available gratis on request.

\*Reg. U. S. Pat. Off.



**ACHESON**  
COLLOIDS CORPORATION  
FOUNDED (1908) AS ACHESON OILDAG COMPANY  
PORT HURON • MICHIGAN

## ASTATIC NON-DIRECTIONAL STUDIO MICROPHONE MODEL K-2 MULTI-UNIT



ITS NON-DIRECTIONAL pickup will reproduce the multiple instruments of a symphony as faithfully as the solo performance of a single instrument or star. A dependable, clear-toned microphone with frequency response substantially flat from 30 to 6000 c.p.s. with rising characteristics to 10,000 c.p.s.—and an output level of -64 decibels (conservatively rated).

WRITE FOR BULLETIN 61

Licensed under patents of Brush Development Company—Astatic Patents Pending. Utilizing grafoil bimorph crystal element.

Featuring the  
DUAL DIAPHRAGM  
CONSTRUCTION

Exclusively Controlled

by



ASTATIC MICROPHONE LABORATORY, INC.  
Youngstown, Ohio, U. S. A.  
Pioneer Manufacturers of Quality  
Crystal Devices



### NEW LOW COST\* A. C. RELAY

1 to 4 sets of contacts.  
10,000 Watt capacity (at 230 volts A.C.—over 10 Amps. per pair of contacts).  
25-30 or 50-60 cycle.  
Coil wound on moulded bakelite bobbin.

\*Example:  
6 volt coil, S.P.S.T. \$2.10  
ea. list Manufacturers'  
Quant. Discs. up to  
70-5%.

Write for Bulletin No. 163

## G-M LABORATORIES INC.

1734 Belmont Avenue

Chicago, U. S. A.

### A TRIAL WILL CONVINCING YOU

35 Years' Experience  
Insures Dependability

We Manufacture  
PERMANENT MAGNETS TOOLS and DIES  
METAL STAMPINGS LAMINATIONS

Suppliers of  
ALNICO MAGNETS

## THOMAS & SKINNER STEEL PRODUCTS CO.

23d St. at Alvord

Indianapolis, Ind.



*For Special*  
**HEAT**  
*CONTROL*  
*Needs*

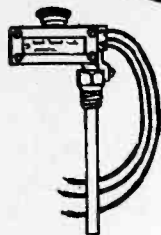

Struthers Dunn can furnish a thermostatic control specially worked out to fit your exact requirements.

Why not explain your needs to an Engineer who has specialized on such problems successfully for years.

*Write for special bulletin.*

**STRUTHERS DUNN, Inc.**  
148 N. Juniper Street  
Philadelphia, Pa.



**THERMOSTATS**

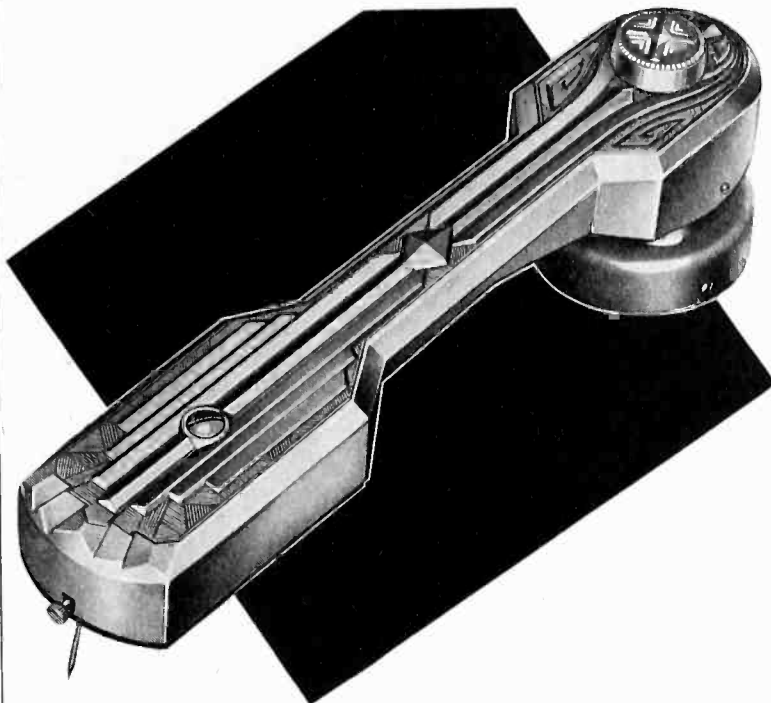

**This Webster Electric  
Pick-Up has these  
Quality Features!**

Designed to precision standards . . . to insure the very highest fidelity of tone . . . to meet the most exacting requirements . . . this Webster Electric Crystal Pick-Up should be accorded first consideration on its performance if for no other reason.

Check these quality-construction features. They tell the complete story.

- 1 Compact with light needle weight on record.
- 2 Free from resonance.
- 3 Lower scratch and distortion level.
- 4 Low mechanical needle point impedance.
- 5 Chatter-Proof—wear-resisting mechanical construction.
- 6 Moulded-in screw terminals—no soldering required. (Avoids possible damage to crystal from heat.)
- 7 Double sealed against moisture.
- 8 Built-in volume control (or without).
- 9 Compensated frequency response (standard or high fidelity).
- 10 Range of voltage output up to 2½V. at 1000 cycles.

The Webster Electric Crystal Pick-Up is available for use with both standard and 16-inch records in both standard and high frequency response.

Send for Bulletin RC-137 which gives you the complete details.

**WEBSTER ELECTRIC COMPANY**  
*Established 1909*

RACINE, WISCONSIN, U. S. A.

Export Department: 100 Varick St., New York, N. Y.

Wherever Sound **W** Must Fill Great Spaces

**WEBSTER**

**ELECTRIC**

*New Savings in  
Coil Costs*

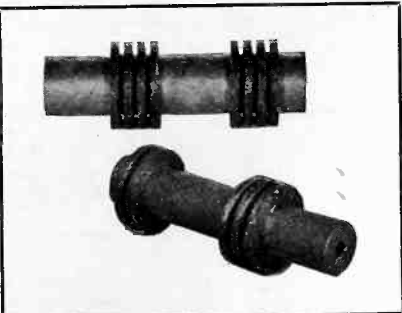

Intermediate-frequency transformer coils, pie-wound, using the Universal No. 84 Machine.

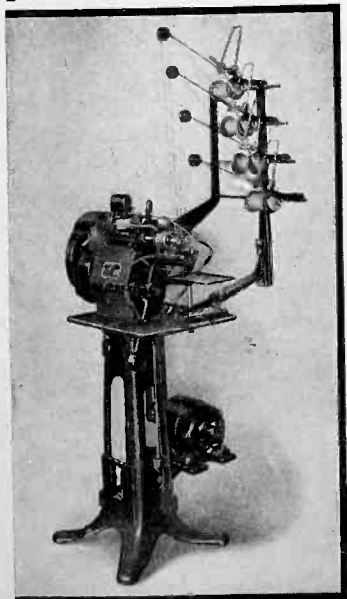

Control of every variable in the winding insures production of coils identical in electrical characteristics. Tension, pressure and wire spacing are determined by positive adjustments. Length of winding is determined by accurately cut cams. The new, quick-setting counter automatically stops the machine when required turns are wound. Actual plant records show gains of from three to four times the production of a single-coil winder.

2570

**UNIVERSAL WINDING COMPANY**  
BOSTON

# WOR GOES PRESTO

**Bamberger Broadcasting Service, Inc.**  
131 Market Street  
Newark, N.J.

NEWARK TELEPHONE  
MARKET 2-1212

**W·O·R**

August 25, 1936.

REPLY TO  
1440 BROADWAY  
NEW YORK  
TEL. PENN. 6-8383

Mr. George Saliba,  
Prosto Recording Company,  
139 West 19th Street,  
New York City.

Dear George:

As a result of several months' intensive investigation and testing both the Prosto Recording machine and Presto Green Seal Blanks, we have come to the conclusion that they are incomparable for the purpose for which they are designed.

As you know, we have had two of your machines here in the WOR laboratory under rigid and constant test for the past three or four months. During that time we have constantly carried out much experimental work along lines, which, if there were any serious flaws in the design of the equipment, would have made them evident. In the course of our tests we have been more than pleased with the hearty cooperation you have extended to us by making adjustments and changes in the equipment from time to time, and we wish to go on record in voicing our appreciation of such service.

The writer wishes to personally thank you for the valued help and information which has so cheerfully been given him.

We are placing our order with you for four machines, type 16 - A, built to specifications given you.

You are aware that these four machines represent WOR's initial step in the direction of recording.

Again thanking you for your cooperation, we are

Yours very truly,

*Ray S. Lyon*

Ray S. Lyon  
Development Engineer.

**WOR** with its powerful 50,000 watt transmitter, is one of the leading stations in the country. No compromise is ever made with quality at **WOR**—price is not considered—every piece of equipment must be the finest obtainable before it is accepted.



Presto Green Seal Disc used by all leading broadcasting stations and transcription laboratories.

The installation of **PRESTO INSTANTANEOUS RECORDING** equipment in the studios of **WOR** after the most gruelling tests that could be devised by the engineering staff is eloquent proof that **PRESTO** has no peer in its field.

*Write for new descriptive catalogue.*

MANUFACTURERS OF THE FAMOUS GREEN SEAL DISCS  
EVERYTHING FOR RECORDING FROM A NEEDLE TO A COMPLETE  
STUDIO INSTALLATION

Export Division (except Australia and Canada)  
M. Simons & Sons, Inc.

25 Warren Street New York, N. Y.  
Cable: Simontrice, N. Y.

# PRESTO

RECORDING CORPORATION  
139 West 19th Street, New York, N. Y.

Automatic  
Electric

## REMOTE CONTROL DEVICES

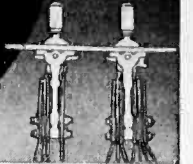
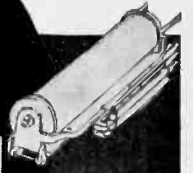
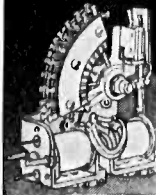

We offer a comprehensive line of electrical control apparatus of proved dependability for adaptation to your products or for use in your production processes. Autelco control devices include:

**RELAYS:** Quick and delayed action types, for A.C. and D.C. circuits, any voltage, any contact combination.

**STEPPING SWITCHES:** Electro-magnetic multi-contact switches, for automatic selection of electrical circuits.

**SWITCHING KEYS:** A variety of locking and non-locking types in any desired contact combination.

Also cords, plugs, jacks, signal lamps, sockets, counters, etc. Write for complete illustrated catalogs.

### American Automatic Electric Sales Company

1023 W. Van Buren Street, Chicago

# ACME LITZ

REDUCES

MANUFACTURING

COSTS in the production of  
I.F. and R.F. coils

1. Ease in Winding
2. Uniformity
3. Low Rejections

Other ACME WIRE CO. Products

MAGNET WIRE (All Insulations)

COILS (Magnet Wire Wound)

VARNISHED INSULATIONS (Cambric, Paper, Silk, Tape)

PARVOLT CONDENSERS (Filter, By-pass,

Power Factor Correction)

AERIAL WIRE (Stranded or Solid, Bare or Enameled)

## THE ACME WIRE CO.

NEW HAVEN, CONN.

For over 30 years, suppliers to the largest  
radio and electrical manufacturers



## EACH *turn* A *separate* STEP

**H**ERE is a power rheostat that gives really *close control*. Note how the contact shoe rides directly on the resistance wire, making each turn of wire a separate step.

Such close control in a power rheostat is possible only because of OHMITE patented construction. There are no organic materials to smoke or char. Wire may be closely wound, and the unit run at rated wattages without danger of burning the core or insulating materials.

OHMITE rheostats are stocked in many sizes and resistance values. Special models designed without cost and delivered on short notice. Write for Catalog 14 . . . FREE!

# OHMITE

## MANUFACTURING COMPANY

*Manufacturers of Resistors and Rheostats of All Types*

4825 FLOURNOY ST.

CHICAGO, ILL.

## GENERAL PURPOSE, RADIO, NEON *Transformers*

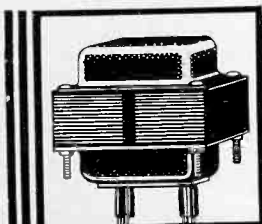

Acme Transformer Engineers know how to make the greatest use of every mechanical and electrical factor in the design and manufacture of transformers. The result—better performance, greater serviceability. Specializing in Transformer manufacture, Acme's price to you is generally much less than your own costs. Send your Transformer inquiries to ACME

**TRANSFORMER *Engineers***



THE ACME ELECTRIC & MFG. CO.  
1447 Hamilton Avenue, Cleveland, Ohio

## GUTHMAN *Coils*

● Guthman Coils are **dependable!** No matter what your requirements, there's a Guthman coil that will fit the job! Send us your specifications— we'll be glad to submit samples and quote **SPECIAL LOW PRICES!**



**EDWIN I. GUTHMAN and CO., Inc.**  
400 South Peoria Street, CHICAGO, ILLINOIS

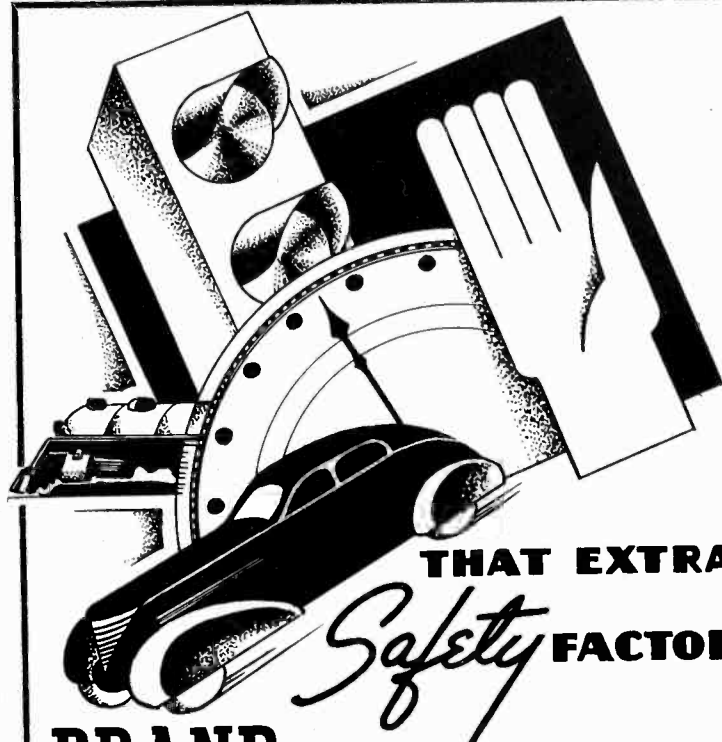

## THAT EXTRA *Safety* FACTOR BRAND INSULATION

It is axiomatic that no product is any better than its poorest component. Since 1920, engineers in the radio and electrical industries have specified "Brand Insulation" because its well-known EXTRA safety margin is an assurance of a better product.

Why gamble with your very business existence by using anything less than the Best in insulation? The Brand Extra Safety Factor protects your reputation— your product— your Business.

*Have you received your copy of our new catalog? It's ready for you!*

Try the "Brand" Brand of Insulating Materials. India Ruby Mica film punchings to any shape . . . size . . . or specification . . . Mica Plate . . . Turbo (Smooth Bore) Oil Tubing, tapes and paper . . . Turbo Oiled Silk and Cambric.

*Large supply carried in centrally located warehouses for prompt shipment of your most pressing production requirements.*

**WILLIAM BRAND & COMPANY**

276 Fourth Ave.  
New York City

217 No. Desplaines St.  
Chicago, Illinois

# BRAND INSULATION

**NEW!**



The **QX-**

**CHECKER**  
TYPE 110-A

A precision instrument for production testing, grouping and adjusting of coils and condensers at radio frequencies. • Essential to present-day checking of radio components within very close tolerances. • Provides a simple, positive, dependable method of comparing *Q* as well as *L* or *C* in *one* operation and in the hands of factory personnel. • Greater accuracy in less time than with previously available equipment. Pays for itself within several weeks, or a few months at most, in typical plants.

Frequency range 100 KCS to 25 MCS, with six plug-in inductors. • AC operated. • High stability. • Special rapid operating meter. • Sturdy construction.

Price, complete with tubes, instruction book and any two frequency bands—\$275. Additional frequency bands, and accessories for condenser testing at nominal prices.

Technical Bulletin describing the QX-Checker sent on request. Also Bulletin on companion instrument, the well-known Q-Meter, for quantitative measurements of *Q* and *L* or *C*.

**Foreign Representatives:**

EUROPE, BRITISH ISLES . . . Sylvan Ginsbury, Brussels, Belgium  
 AUSTRALIA, NEW ZEALAND . . . Tyme Ltd., Sydney, Australia  
 CENTRAL and SO. AMERICA . . . Rocke International, N. Y. City  
 JAPAN and MANCHUKUO . . . Okura & Co. Tokio, Japan

**BOONTON**  
*Radio Corporation*  
**BOONTON NEW JERSEY**

**INDEX TO ADVERTISERS**

	Page		Page
Acheson Colloids Corp. . . . .	94	Mallory & Co., Inc. P. R. . . . .	10
Acme Wire Co. . . . .	96	McGraw-Hill Book Co. . . . .	88-98
Acme Elec. & Mfg. Co. . . . .	97	Mica Insulator Co. . . . .	74
Aerovox Corp. . . . .	86	Ohmite Mfg. Co. . . . .	97
Aladdin Radio Ind., Inc. . . . .	100	Parker Kalon Corp. . . . .	81
Allen Bradley Co. . . . .	89	Pioneer Gen-E Motor Corp. . . . .	92
Allied Recording Prod. Co. . . . .	76	Precision Resistor Corp. . . . .	96
American Lava Corp. . . . .	85	Presto Record Corp. . . . .	96
American Transformer Corp. . . . .	38	Radio Receptor Co. . . . .	82
Amperite Co., Inc. . . . .		RCA Communication, Inc. . . . .	86
	Inside Front Cover	RCA Mfg. Co. . . . .	Back Cover
Astatic Microphone Co. . . . .	94	Remler Co., Ltd., The . . . . .	64
Audak Co., The . . . . .	5	Shakeproof Lock Washer Co. . . . .	71
Automatic Electric Co. . . . .	96	Shallcross Mfg. Co. . . . .	90
Bakelite Co. . . . .	39	Shure Brothers . . . . .	88
Biddle Co., James G. . . . .	100	Sigma Instr. Inc. . . . .	90
Boonton Radio Corp. . . . .	98	Solar Mfg. Co. . . . .	79
Brand & Co., Wm. . . . .	97	Sound Apparatus Co. . . . .	70
Brush Development Co. . . . .	72	Stackpole Carbon Co. . . . .	4
Callite Products Co. . . . .	72	Superior Tube Co. . . . .	2-3
Cannon Electric Dev. Co. . . . .	75	Swedish Iron & Steel Co. . . . .	62
Carter Motor Co. . . . .	100	Techna Corp. . . . .	41
Central Radio Labs. . . . .	69	Thomas & Skinner Steel Prod. Co. . . . .	97
Cinaudagraph Corp. . . . .	84	Thordarson Electric Co. . . . .	66
Cinch Mfg. Corp. . . . .	7	Triplett Elec'l. Instr. Co. . . . .	9
Clarostat Mfg. Co. . . . .	78	Triumph Mfg. Co. . . . .	68
Continental Elec. Co. . . . .	76	Truscon Steel Co. . . . .	93
Continental Diamond Fibre Co. . . . .	61	United Sound Eng. Co. . . . .	88
Cornell Dubilier Corp. . . . .	73	Universal Microphone Co., Ltd. . . . .	82
Crescent Ins. Wire & Cable Co. . . . .	83	Universal Winding Co. . . . .	95
Crowley Co., H. L. . . . .	80	Ward Leonard Electric Co. . . . .	66
Daven Co., The . . . . .	99	Webster Electric Co. . . . .	95
Dumont Labs., Allen B. . . . .	42	Western Electric Co. . . . .	37
Dunn Ins., Struthers . . . . .	95	Weston Elec'l. Instr. Corp. . . . .	63
Erie Resistor Corp. . . . .	6	White Dental Mfg. Co., . . . . .	8
Fairchild Aerial Camers Corp. . . . .	77		
Ferranti, Inc. Inside Back Cover		Professional Services . . . . .	84
Ferris Instrument Corp. . . . .	40		
Formica Insul. Corp. . . . .	87	<b>SEARCHLIGHT SECTION</b>	
General Ceramics Co. . . . .	91	<i>Classified Advertising</i>	
General Insulated Wire Co. . . . .	82	<b>BUSINESS OPPORTUNITIES . . . . .</b>	84
General Radio Co. . . . .	67	<b>EMPLOYMENT . . . . .</b>	84
G-M Laboratories . . . . .	94	<b>EQUIPMENT FOR SALE . . . . .</b>	
Goat Radio Tube Parts, Inc. . . . .	74	American Electrical Sales . . . . .	100
Guardian Elec. Mfg. Co. . . . .	64	Eisler Electric Corp. . . . .	100
Guthman & Co., Inc., Edw. I. . . . .	97	Electronics Machine Co. . . . .	100
Hammarlund Mfg. Co. . . . .	76	Kahle Engineering Corp. . . . .	100
Heintz & Kaufman Ltd. . . . .	84	Winslow, Louis J. . . . .	100
International Resistance Co. . . . .	55		
Isolantite, Inc. . . . .	65		
Lansing Mfg. Co. . . . .	68		
Leach-Relay Co. . . . .	86		
Lenel High Frequency Labs. . . . .	62		
Lifetime Corp., The . . . . .	86		

Just published — Zeh Bouck's

**Making  
a Living  
in Radio**

Foreword by  
Alfred N. Goldsmith  
220 pages, \$2.00

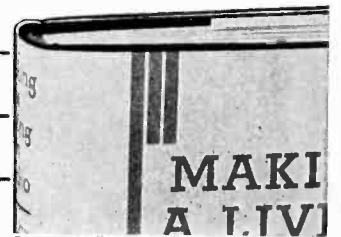

**WHAT** are the opportunities in radio? This frank, impartial survey of the whole field tells you. The book covers engineering, operating, servicing, broadcasting, writing, salesmanship, etc., telling what jobs there are, what they pay, how to train for them, how to break into the game, and then get ahead.

**Are you interested in . . . ?**

- how to determine whether or not radio is your vocation
- how to choose a school
- what books to buy
- how the operator can get a berth
- business expansion and engineering careers for the serviceman
- breaking into broadcasting, etc

Then see this new book. Interesting, up-to-date, sound, authoritative. Sent for 10 days' examination on approval. Just mail the coupon, today.

.....  
 McGraw-Hill Book Co., Inc., 330 W. 42nd St., N. Y. C.  
 Send me Bouck's Making a Living in Radio for 10 days' examination on approval. In 10 days I will send \$2.00, plus few cents postage, or return book postpaid. (Postage paid on orders accompanied by remittance.)

Name .....

Address .....

City and State .....

Position .....

Company .....

FL-9-36

(Books sent on approval in U. S. and Canada only.)

# DAVEN 30 STEP "TEE" ATTENUATOR

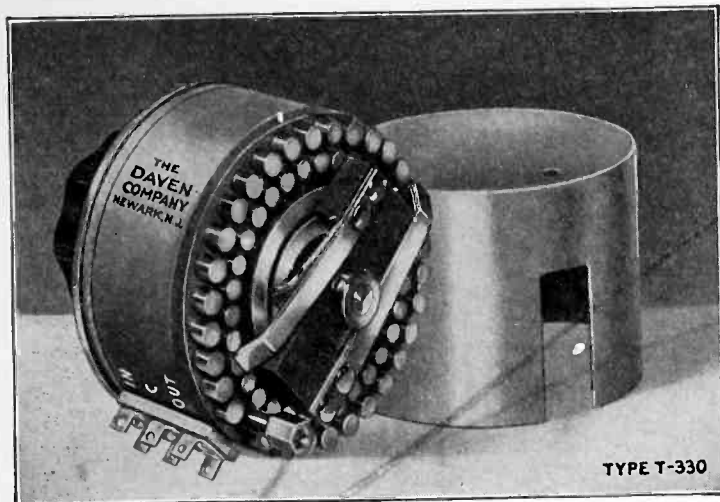

## TYPE "T-330"

This is the first compact 30 step "T" attenuator ever offered at a low cost. Prior to our first public announcement in the May issue of Electronics, we have sold a large number of these units which have proven very satisfactory. It is perfect as a mixer and a master gain control for low level mixing. The new Attenuator has zero insertion loss, constant impedance both in and out at all settings and at all frequencies within the desired range, and the lowest attainable noise level.

### SPECIFICATIONS

30 STEPS OF ATTENUATION.  
LAMINATED POSITIVE WIPING TYPE SWITCH.  
LOW NOISE LEVEL. BELOW -130 DB.  
SHIELDED FROM ELECTRICAL DISTURBANCES.  
RUGGED—LIGHT WEIGHT  
SIZE ONLY 2 $\frac{3}{4}$ " DIAMETER BY 2 $\frac{1}{2}$ " IN DEPTH.  
ZERO INSERTION LOSS  
FREQUENCY ERROR: NONE OVER THE RANGE OF  
30 TO 17,000 CPS.  
RESISTORS, UNIFILAR WOUND  
POPULAR PRICED.

The following impedances stocked for immediate shipment:

30/30	200/200	600/600
50/50	250/250	30/50
125/125	500/500	50/200
	500/200	

Special impedances and attenuation upon request.

Mfrs. of Volume Controls, Potentiometers, Faders, Main Gain Controls, Fixed Attenuators, Non-Inductive Wire Wound Resistors, Line Equalizers, Volume Indicators, and Laboratory Equipment. Write for Bulletins.

WRITE FOR BULLETIN 534

## THE DAVEN COMPANY

158-160 SUMMIT STREET

NEWARK, N. J.

# DO A WELL-ROUNDED JOB!

## INCLUDE ★ DIRECT MAIL IN YOUR SALES PLAN

- to complement your magazine advertising
- to make direct sales
- to invite inquiries about your product or service
- to obtain leads for your salesmen
- to keep your prospects informed of your products or service
- to help announce a new product effectively

★ Use McGraw-Hill Direct Mail Division lists so that you get full value from every dollar. McGraw-Hill spends over \$100,000 a year in building and maintaining lists and has a field force of over 200 men cooperating on these lists. The results are accurate, daily corrected lists so carefully checked and selected they insure maximum results from your efforts.

Write, wire or phone today for detailed list information on **Radio Engineers** and **Radio Trade Outlets**

DIRECT MAIL DIVISION

McGRAW-HILL PUBLISHING CO., INC., 330 West 42nd Street, New York, N. Y.

# Polyiron Conquers the Ether

# Aladdin

TRADE MARK REG. U.S. PAT. OFF.

GREATER GAIN  
BETTER DX  
INCREASED SELECTIVITY  
LOWER NOISE LEVEL

Send for technical data  
bulletin 536  
**ALADDIN RADIO  
INDUSTRIES, Inc.**  
466L West Superior St.  
CHICAGO, ILL.  
Licence of  
Johnson Laboratories, Inc.

## HI-POWER FOR PORTABLE SOUND EQUIPMENT

The Carter GENEMOTOR supplies the most reliable and economical "B" Power for Class A or B amplifiers from a 6 or 12 volt battery. Output up to 500 volts. Sturdy — Compact — Quiet in operation — Requires no oiling — Guaranteed. Also can be supplied for A.C. output.

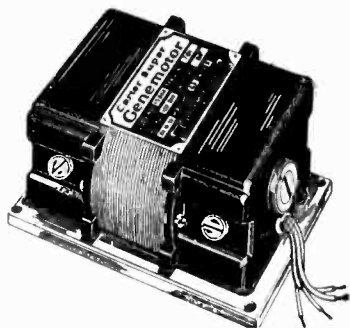

Write for Circular

**CARTER MOTOR CO.**  
365 W. Superior St., Chicago

## BIDDLE SPECIALTIES

- "MEGGER" Insulation Testers and Ohmmeters
- "MEGGER" Capacitance Meter
- "FRAHM" Frequency Meters
- "JAGABI" Rheostats
- "APIEZON" Oils, Greases and Waxes for High Vacuum Work

## "JAGABI" RHEOSTATS



FOR fine adjustment and control of electric current, these devices have performed—for many years—an outstanding service in the manufacture and use of electronic tubes, and in general laboratory and experimental work. Four sizes; 76 different ratings; numerous special types.

Write for descriptive Catalog 1370-E

**JAMES G. BIDDLE CO.**  
ELECTRICAL AND SCIENTIFIC INSTRUMENTS  
1211-13 ARCH STREET · PHILADELPHIA · PENNSYLVANIA

### POSITIONS WANTED

**ELECTRICAL ENGINEER** desires location in engineering department of radio receiver manufacturer or component parts manufacturer. Years experience in design of audio and RF testing equipment for production of multi-band receivers. Also, experience in receiver design. Location immaterial, providing salary justifies. Age 28, Eta Kappa Nu, Tau Beta Pi. P.W.-90, Electronics, 330 West 42nd Street, New York City.

**PATENT ATTORNEY**, specialist in electronics and allied arts desires position with manufacturing or research organization. Formerly in charge of foreign department of radio manufacturing organization. First class references. PW-93, Electronics, 330 West 42nd Street, New York City.

### BUSINESS OPPORTUNITY

Wanted Licenses

under any patents issued in television field. BO. 92 Electronics, 330 W. 42nd St., New York City.

(POSITIONS VACANT)

- 1—M. E. on the mechanical design of radio receivers.
- 1—Radio Engineer on set development and research.
- 1—Radio Tube Engineer.
- 1—Physicist with experience on photo electric cell development.

Salaries to \$100 weekly.

**SOFIELD TECHNICAL AGENCY**  
270 Broadway New York, N. Y.

(POSITION WANTED)

### COMMERCIAL RADIO ENGINEER

Hollander, under 35, with long European experience in market research, electrical, feature and cabinet design, technical publicity and dealer education, speaking and writing perfectly French and German, wants position with large manufacturing organization.

PW 91 Electronics  
330 West 42nd Street, New York City

### New "SEARCHLIGHT" Advertisements

must be received by the 30th of the month to appear in the issue out the following month.

Address copy to the  
Departmental Advertising Staff

Electronics  
330 West 42d St., New York City

### SEARCHLIGHT SECTION

## VACUUM TUBE EQUIPMENT

Formerly production units of  
**JOHNSONBURG RADIO CORPORATION**

Including:

- "Hijet" Unit Heaters
- Power Transformers
- Motor Generator Units
- Hydrogen Furnaces
- Filament Coating Units
- Hofmann Exhaust Units
- Lepel Bombarders
- Weston & Rawson Meters
- Biddle Slide Wire Rheostats
- B. & L. Spectrometer
- Kinney & Eisler Pumps
- Eisler ½ K.V.A. Welders
- York Soldering Machine
- York Base Brander

PRICES ON INQUIRY

**A. E. LYLE, Johnsonburg, Penna.**

## DEPENDABLE

New and Used

### ELECTRONIC TUBE EQUIPMENT

A complete line of equipment for the manufacture of Radio Tubes, New Tubes, Incandescent Lamps, etc.

Write for Bulletin showing savings from 25 to 75%

**EISLER ELECTRIC CORP.**  
534-39th Street, Union City, N. J.

Meters repaired, made more serviceable. Conversion to higher sensitivity as high as 10 microamperes for Weston type 1 or 24-57.

Sensitive vacuum thermo couples  
For Sale used Weston panel meters,  
Rawson microammeters

Reasonable prices.

**Precision Electrical Instrument Co.**  
561 Broadway, N. Y. C.

## CASH WAITING

We pay highest prices for your surplus laboratory equipment as meters, rheostats, bridges, decade boxes, etc. Submit your lists of what you have to offer.

**AMERICAN ELECTRICAL SALES CO.**  
65-67 E. 8th St. New York, N. Y.

## COMPLETE EQUIPMENT

New and Used for

## ELECTRONIC TUBE MAKING, LABORATORY, and SCHOOL UNITS

Glass Cutters, Spot Welders, Annealers, Flare,  
Stem, Sealing, and Basing Machines,  
Vacuum Pumps, Burners

## ELECTRONICS MACHINE CO.

751 13th Street, Newark, N. J.

## Used Lab. Equipment

Weston—G.R.—L&N—G.E., Etc.

Meters—Bridges—Torsion balances—Inductors—  
Decade boxes—Analytical balances—Oscillographs  
—Jagabi rheostats—Signal Generators—Condensers

Write for my list

**LOUIS J. WINSLOW**  
200 Pennsylvania Avenue Hillside, N. J.

## HIGH GRADE NEW AND USED ELECTRON TUBE EQUIPMENT

Huge Stock of Equipment of  
Every Type and Variety

**KAHLE ENGINEERING CORPORATION**  
Specialists in Equipment and Methods for the  
Manufacture of Neon Tubes, Radio Tubes, Incan-  
descent Lamps, Photo Cells, X-ray Tubes, etc.  
941 DeMott St., North Bergen, N. J.

## WANTED USED Engraving Machine

State condition and price

**ELECTRONIC ENGINEERING CO.**  
755 Union St. San Diego, Calif.

Announcing  
**2** entirely  
**NEW**  
**TRANSFORMERS**

by  
**FERRANTI**

Series A  $\pm$  1 db. 30 to 12,000 cycles  
 Case  $2\frac{3}{8}$ " x  $2\frac{1}{8}$ " x 3" h.  
 Mntg.  $2\frac{1}{8}$ " x  $1\frac{3}{8}$ "

Series B  $\pm$   $\frac{1}{2}$  db. 30 to 16,000 cycles  
 Case  $2\frac{3}{8}$ " x  $1\frac{1}{8}$ " x  $3\frac{3}{8}$ " h.  
 Mntg.  $2\frac{1}{8}$ " x  $1\frac{3}{8}$ "

**FEATURES . . .**

1. 90 New Transformers in All
2. New Low Prices
3. New Designs Throughout
4. Latest High Fidelity Standards
5. New Self Shielding Core Type Construction
6. Free from Hum and Pickup
7. New Reversible Through-Type Mountings
8. No Waste Space for Mounting Flanges or Feet
9. Electrostatic Shields Between Windings
10. Small in Size
11. Light in Weight
12. Exceptionally Low Insertion Loss
13. Moisture-Proof Construction
14. Available for Immediate Shipment from Stock
15. Designed and Manufactured in the United States

The "A" Series is the lowest priced self-shielding transformer available . . . New straight-through mounting on both series, plus self-shielding enables units to be actually mounted against each other . . . no waste space . . . every unit designed for either top or subpanel mounting.

SEND FOR COMPLETE LISTING.

**FERRANTI ELECTRIC, INC.**

30 Rockefeller Plaza, New York, N. Y.

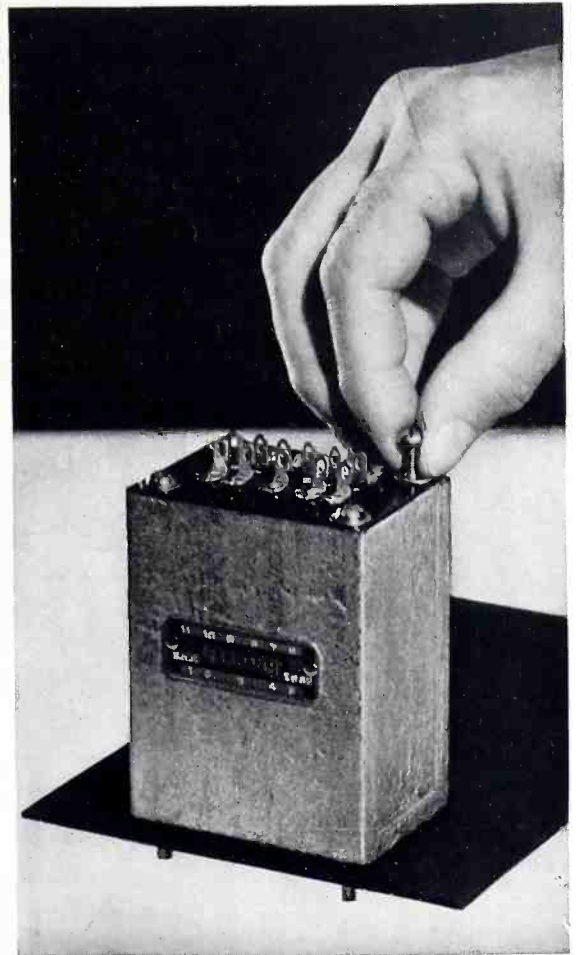

Mirror Illustrates  
 New Sub-Panel  
 Mounting

**THE NEW RCA-6L6  
ALL-METAL TUBE**

Amplification factor, 135; mutual conductance, 6,000 Micromhos. Maximum signal power outputs: single-tube Class A<sub>1</sub> amplifier, 11.5 watts; push-pull Class A<sub>1</sub>, 14.5 watts; push-pull Class AB<sub>1</sub>, 34 watts; push-pull Class AB<sub>2</sub>, 60 watts. Illustration shows tube actual size.



*Here is the new RCA-6L6*  
**BEAM POWER AMPLIFIER**

This new tube makes use of fundamentally new principles involving the production of beams of high electron density. Two principal results are that the screen does not absorb appreciable power, and that efficient suppressor action is supplied by space-charge effects between screen and plate. Features are high power-handling ability, high efficiency, and high power sensitivity.

Third harmonic distortion is low at all power levels; higher-order harmonics are negligible. Second harmonic distortion is relatively high, but is easily made small or eliminated by circuit design. Because of the high power-sensitivity of the new 6L6, circuits may be used that avoid the troublesome effects of loudspeaker resonance and variable impedance. In such circuits the tube provides power sensitivity and stability equal to or better than that of a triode. Manufacturers and engineers are invited to write for technical information.

*RCA Radiotron*

RCA Manufacturing Company, Inc., Camden, New Jersey  
A Service of RADIO CORPORATION OF AMERICA

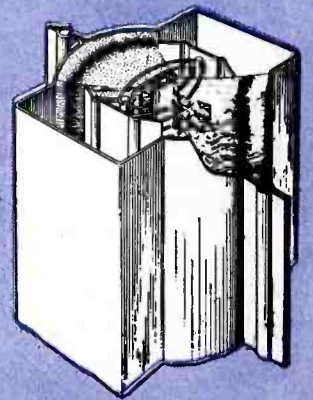

Sectional view showing elements of the new 6L6, and electron beam formation.

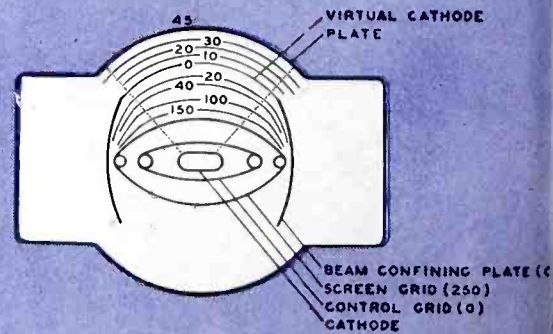

Top view of tube elements, showing potentials in beam.

